

Wireless World

RADIO AND ELECTRONICS



JUNE 1949

2/-

IN THIS
ISSUE :

CONTRAST EXPANSION METHODS REVIEWED

Vol. LV. No. 6

B.I.C.C.

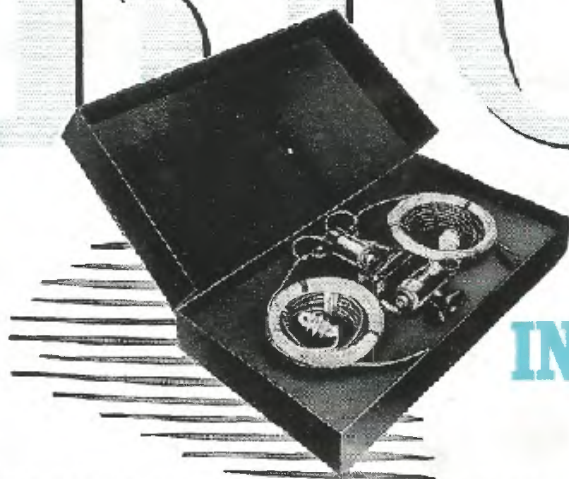

All Wave
ANTI-INTERFERENCE AERIAL

THERE'S A NAME BEHIND IT!

WHAT IT DOES It has been specially designed to alleviate interference caused by radiation from electrically-operated transport, vehicle ignition systems, electrical appliances using commutator motors, lighting systems, etc. A high signal level is obtained and this ensures better listening on all broadcast wavelengths, giving maximum choice of programmes against a quiet background.

WHAT IT IS A 60-ft. polythene-protected dipole complete with insulators and matching transformer, 80-ft. coaxial screened downlead with polythene plug moulded to each end, and a receiver transformer. All the necessary components for the Aerial are included in the complete kit.

Write for Publication No. 221S giving further information.

Obtainable only from recognised dealers. £6.18.0



All Wave
ANTI-INTERFERENCE AERIAL

BRITISH INSULATED CALLENDER'S CABLES LIMITED
 NORFOLK HOUSE, NORFOLK STREET, LONDON, W.C.2

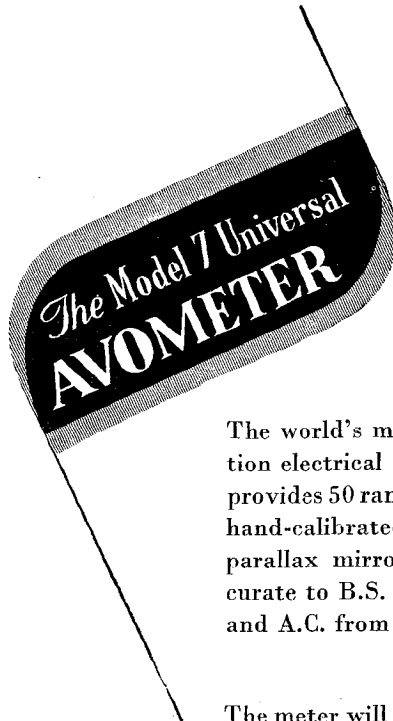
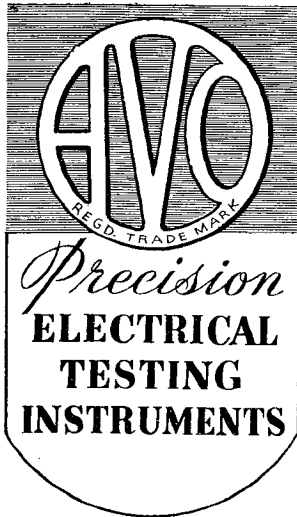

The world's most widely used combination electrical measuring instrument. It provides 50 ranges of readings on a 5-inch hand-calibrated scale fitted with an anti-parallax mirror, and is guaranteed accurate to B.S. first grade limits on D.C. and A.C. from 25c/s to 2Kc/s.

The meter will differentiate between A.C. and D.C. supply, the switching being electrically interlocked. The total resistance of the meter is 500,000 ohms.

CURRENT: A.C. and D.C. 0 to 10 amps.
 VOLTAGE: A.C. and D.C. 0 to 1,000 volts.
 RESISTANCE: Up to 40 megohms.
 AUDIO-FREQUENCY POWER OUTPUT:
 0—4 watts.
 DECIBELS: —25Db. to +16Db.

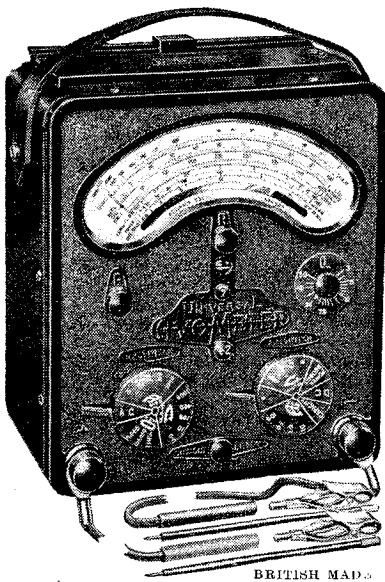

BRITISH MADE

PRICE

£19: 10s.

Size: 8" x 7 $\frac{1}{4}$ " x 4 $\frac{1}{2}$ ".Weight: 6 $\frac{3}{4}$ lbs. (including leads).

The instrument is self-contained, compact and portable, simple to operate and almost impossible to damage electrically. It is protected by an automatic cut-out against damage through severe overload.

Various accessories are available for extending the wide ranges of measurements quoted above.

Fully descriptive pamphlet available on application.

Sole Proprietors and Manufacturers:—

The AUTOMATIC COIL WINDER & ELECTRICAL EQUIPMENT CO. LTD.
 WINDER HOUSE · DOUGLAS STREET · LONDON · S.W.1 Telephone: VICTORIA 3404/9

Success through constant research - can we help you?

LOW LOSS CERAMICS

by

TAYLOR TUNNICLIFF

TAYLOR TUNNICLIFF (REFRACATORIES) LTD.,
Albion Works, Longton, Stoke-on-Trent, Staffs.
London Office: 125 High Holborn, W.C.1.
Phones: Stoke-on-Trent 5272 & Holborn 1951/2.

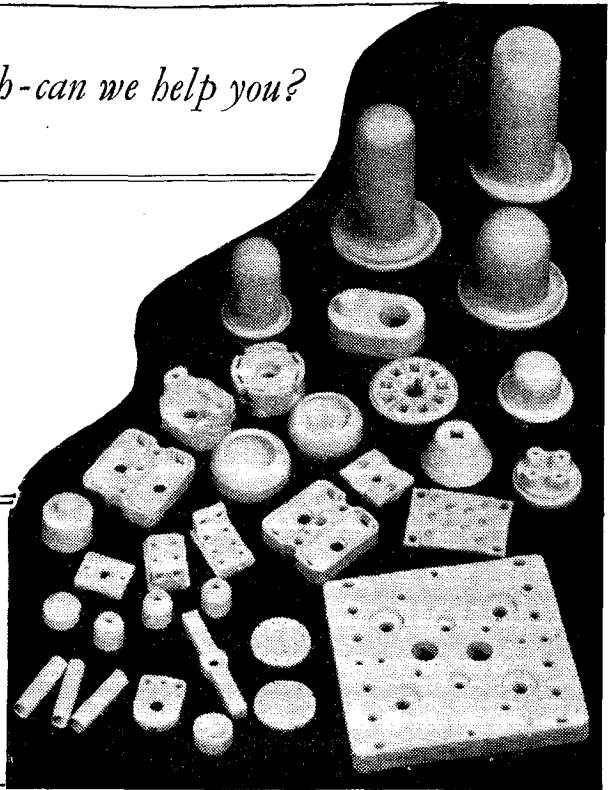

T.A.S./T.T.8

For all Electrical Tests

PIFCO

ALL-IN-ONE RADIOMETER

with internal battery and multi scale the PIFCO All-in-One Radiometer tests everything electrical, Radio and P.A. Equipments, Household appliances of all kinds. Car Lighting Systems, Bell and Teleprinter Circuits. May be used on AC or DC mains.



● **CIRCUIT TEST**

Tests for open or faulty circuits in all radio and electrical apparatus and domestic appliances. Equally for testing car lighting and starting circuits.

● **L.T. TEST**

0-6 volts AC or DC.
● **MILLIAMPERE TEST**
0/23 m.a. scale for testing total discharge from battery or testing single cell.

● **H.T. TEST**

0-240 volts. May be used direct on any mains, AC or DC

● **VALVE TEST**

Made by inserting valve in socket on front of meter.

Write for full details and Export terms. Overseas Agency enquiries invited.

PIFCO LTD., PIFCO HOUSE, WATLING STREET, MANCHESTER, 4
and at PIFCO HOUSE, GT. EASTERN STREET, LONDON, E.C.2

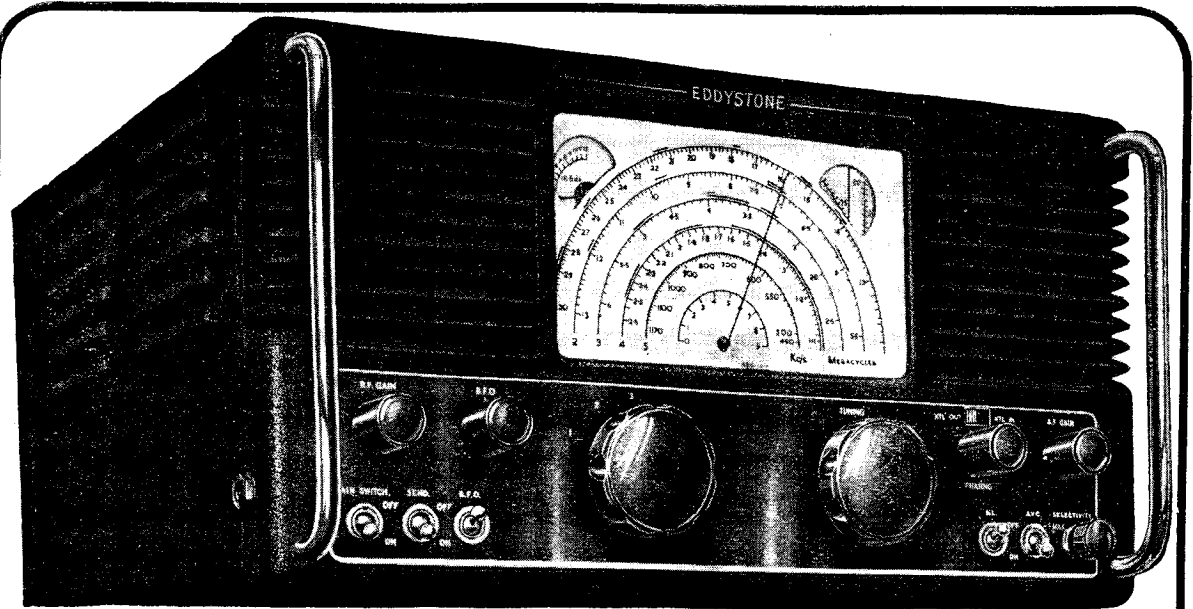

The NEW EDDYSTONE '680' COMMUNICATIONS RECEIVER

A high-grade instrument with wide frequency coverage for PROFESSIONAL COMMUNICATION REQUIREMENTS

The '680' is a fifteen valve superheterodyne receiver embodying advanced technique. New features in the design add to the outstanding and reliable performance of which the receiver is capable. The appearance is impressive, whilst the construction and general workmanship are of the finest in the industry.

SPECIAL FEATURES INCLUDE:

- Continuous coverage from 30 Mc/s to 480 Kc/s.
- Two Radio-Frequency stages.
- Two I.F. stages.
- Crystal Filter.
- Beat Frequency Oscillator.
- Push-pull output stage.
- Variable Selectivity.
- "S" Meter.
- Noise Limiter.
- Standby switch.
- Stabilised H.T. voltage to Oscillator, etc.
- Provision for relay operation of transmitter.
- High signal-to-noise ratio and sensitivity.
- Highly attenuated Image response.
- Very effective A.V.C.
- Large accurately calibrated dial.
- Provision for twin feeder and single aerial.
- Variable dial illumination.
- Modern miniature all-glass valves.
- Flywheel loaded tuning device - 140 to 1 reduction ratio.
- Mechanical bandspread logging device.
- All controls separate and conveniently arranged.
- Robust construction.
- Finished for tropical service.

The complete frequency range—from 30 Mc/s to 480 Kc/s—is covered by five switched coil assemblies with an overlap between each. The gear-driven, flywheel controlled mechanism is positive, free from backlash and very smooth in action. The mechanical bandspread device takes the form of an auxiliary dial and gives a scale length equal to nineteen inches per range. The dial can be read to one degree. I.F. transformers are permeability tuned to 450 Kc/s. Operates from A.C. mains, 110 and 200/240 volts, 40/60 cycles. The front panel and tuner unit chassis are aluminium, and the remaining units of stout brass, heavily nickel-plated. Lift-up lid. The cabinet and front panel are finished a handsome ripple black, set off by plated handles. The finger plate is black and silver.

Dimensions:—16½" × 13¾" × 8¾" high.

LIST PRICE IN U.K. £85 (No Purchase Tax)

Government Departments, Official bodies and all interested individuals are invited to write for completely informative folder to

STRATTON & CO. LTD.

EDDYSTONE WORKS, ALVECHURCH ROAD, WEST HEATH, BIRMINGHAM, 31
Cables: STATNOID, BIRMINGHAM

Telephone: PRIORY 2231/4

Webb's RADIO

High Fidelity Reproduction

has for many years been a major speciality with WEBB'S and we demonstrate the leading makes of amplifiers, loudspeakers, radio feeder units and pick-ups.

We invite you to hear and compare :—

LEAK "POINT ONE" AMPLIFIER.

The amplifier that cannot be technically faulted either on its measured performance or engineering workmanship. Aural judgment amply confirms the maker's claims.

Price £25 15 0

(Separate LEAK remote control pre-amplifier. Price £6 15 0)

ACOUSTICAL "QA/12/P" AMPLIFIER.

Unexcelled for high-quality combined with extreme compactness. Including built-in pre-amplifier giving bass and treble control, the size is 10½ in. x 8½ in. x 7 in.

Price £30 0 0

Hear these (and other good amplifiers, such as Charles, Webb's "MC/QA," Sound Sales, etc.) working with speciality equipment.

LOUDSPEAKERS.

Voigt Domestic	£87 10 0
Mordaunt "Duplex"	98 Guineas
Wharfedale "Corner"	£48 10 0
Barker "148A" Chassis	£15 15 0
Sound Sales "Phase Inverter"	£12 10 0
Acoustical "Labyrinth"	£19 10 0
Wharfedale W15CS	£12 10 0

Also—Rola G12—Wharfedale W12CS—Goodmans Axiom—B.T.H. R.K., etc.

PICK-UPS.

Wilkins & Wright "N" Moving Coil ..	£7 10 7
Brierley "Ribbon"	£10 14 9
Connoisseur Moving Iron	£4 10 6
Decca Type "D"	£6 4 4

This is only a selection from probably the largest and most varied stock of "High Fidelity" apparatus in the Country.

★ Webb's Extended Payment Scheme available on all equipment.

WHY NOT HEAR AND DECIDE FOR YOURSELF IN OUR DEMONSTRATION ROOM ?

Webb's Radio, 14, Soho St., Oxford St., London, W.1

Phone : GERrard 2089. Shop Hours : 9 a.m.—5.30 p.m. Sats. 9 a.m.—1 p.m.



D.C.
Oscilloscope 1684D/2

AN EXAMPLE from the Furzehill range of fine instruments is this high-grade oscilloscope for industrial, radio and television applications. Both axes have identical d.c. coupled high sensitivity amplifiers with symmetrical inputs and a level frequency characteristic from zero to 3 M/cs. Particularly valuable features are the instantaneous action of the shift controls, expansion of the time base scan from ½ to 5 screen diameters, negligible phase shift in the amplifiers and automatic amplitude-limited synchronisation.

For full details of this, and other instruments in the Furzehill range, write for our new illustrated catalogue.



FURZEHILL LABORATORIES LIMITED
BOREHAM WOOD . HERTS . Tel. ELStree 1137

Construction Materials *for* THERMIONIC VALVES

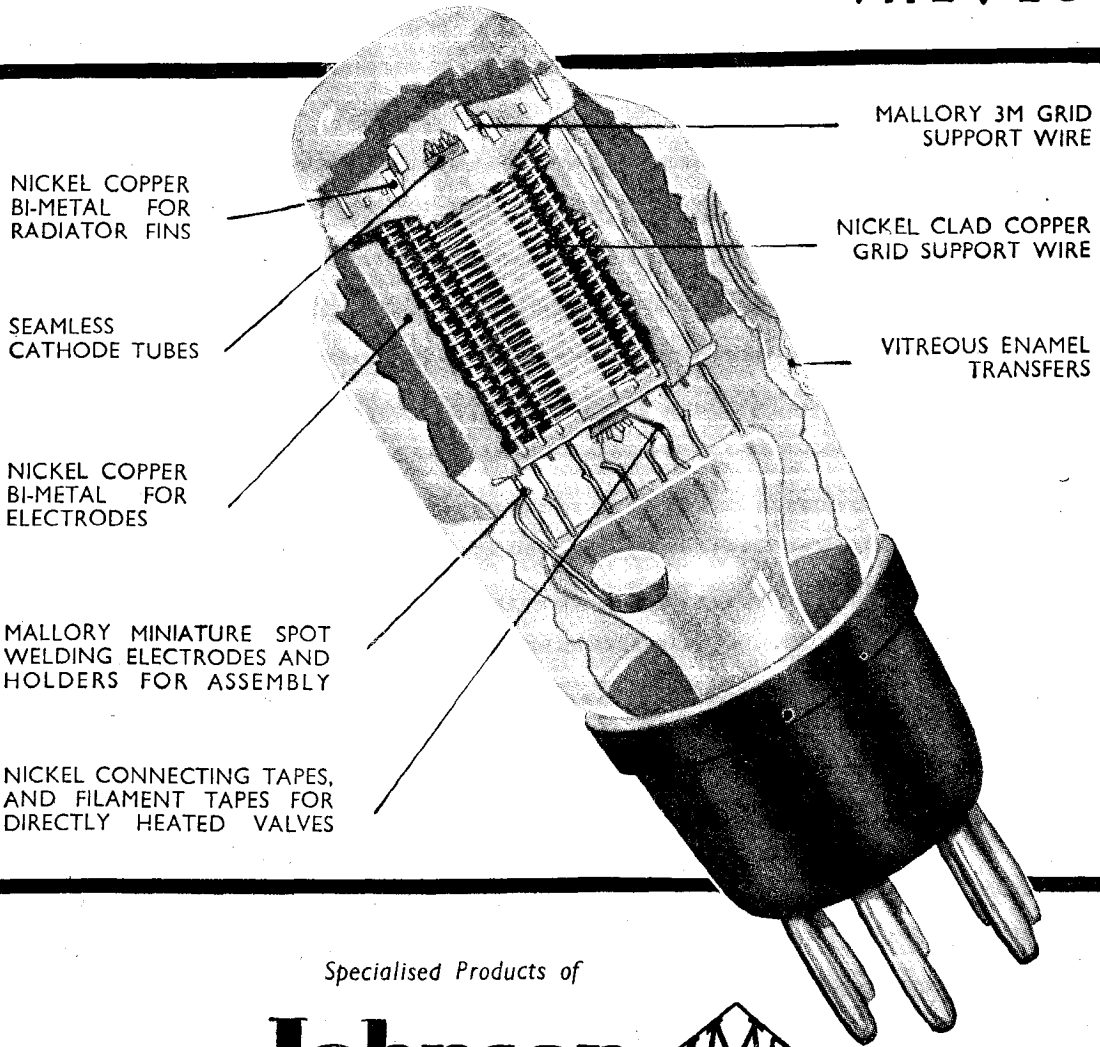

MALLORY 3M GRID SUPPORT WIRE

NICKEL CLAD COPPER GRID SUPPORT WIRE

VITREOUS ENAMEL TRANSFERS

NICKEL COPPER BI-METAL FOR RADIATOR FINS

SEAMLESS CATHODE TUBES

NICKEL COPPER BI-METAL FOR ELECTRODES

MALLORY MINIATURE SPOT WELDING ELECTRODES AND HOLDERS FOR ASSEMBLY

NICKEL CONNECTING TAPES, AND FILAMENT TAPES FOR DIRECTLY HEATED VALVES

Specialised Products of

Johnson 
Matthey

JOHNSON, MATTHEY & CO., LIMITED, HATTON GARDEN, LONDON, E.C.1

Telephone : HOLborn 9277

MYCALEX

(REGD. TRADE MARK)

THE INSULATOR

May solve your Insulation Problems
with the following

UNIQUE COMBINATION OF PROPERTIES

- HIGH DIELECTRIC STRENGTH
- NON-TRACKING
- LOW-LOSS FACTOR
- RESISTANT TO FUNGUS GROWTH
- HEAT RESISTING
- WILL NOT SHRINK OR WARP
- MANUFACTURED TO CLOSE TOLERANCES
- LOW EXPANSION CO-EFFICIENT

MACHINED TO CUSTOMER'S REQUIREMENTS OR AVAILABLE
IN SHEETS, RODS AND MOULDINGS

Also makers of INGRAM MYCALEX Capacitors utilising MYCALEX
as a dielectric with plates moulded in, to form a sealed unit

Phone: CIRENCESTER. 400 or send enquiries to

MYCALEX COMPANY LTD · ASHCROFT ROAD · CIRENCESTER GLOS

Simplicity—

To the squirrel, the task of cracking a nut and extracting the kernel is simplicity itself. To the engineer, the task of tackling a difficult fault on a defective radio set or other electrical equipment and getting to the source of the trouble quickly is greatly simplified with the aid of a Weston Model E772 Analyser. This instrument has high sensitivity—20,000 ohms per volt on all D.C. ranges—its quality is unequalled and it is designed to save you time, trouble and money. Please write for details.

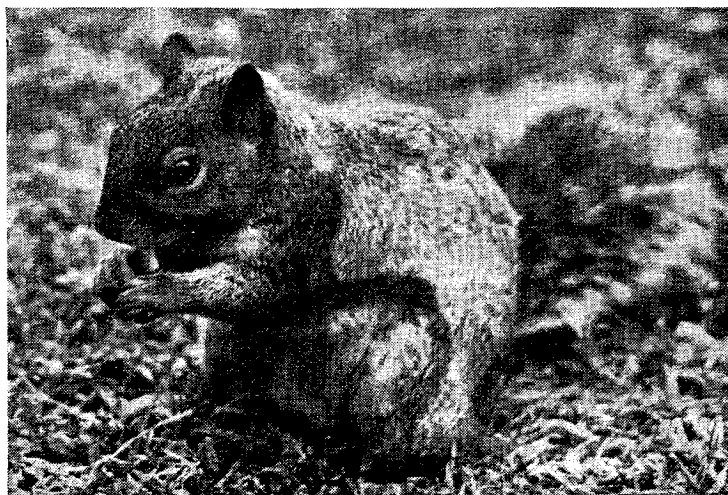

WESTON^{E 772} Analyser

SANGAMO WESTON LTD. · ENFIELD · MIDDX.

Telephone: Enfield 3434 & 1242



QUALITY TRANSFORMERS

FOR

RADIO, TELEVISION AND INDUSTRIAL ELECTRONICS

Woden Transformers are specified in many prominent journals. Components are available for "Wireless World," Williamson Amplifier, "Electronic Engineering" Home Built Televisor, R.S.G.B. Modulator, etc.

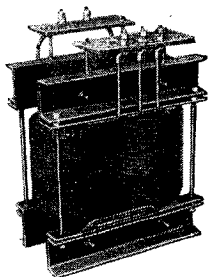

Industrial Transformers, one, two or three phase either open or protected, oil or air cooled, are made for many purposes including Power Distribution, Electric Furnaces, Radio Transmitters, R.F. Heating Equipment, Electronic Apparatus, etc. All types are made up to 100 KVA.

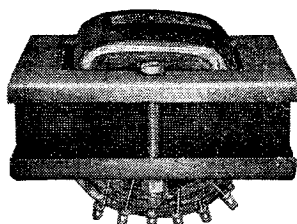

Type R.M.S. 31

Type R.M.S. 31 Drop Through Transformers, as shown above, are particularly suitable for Set Manufacturers and for service replacements.

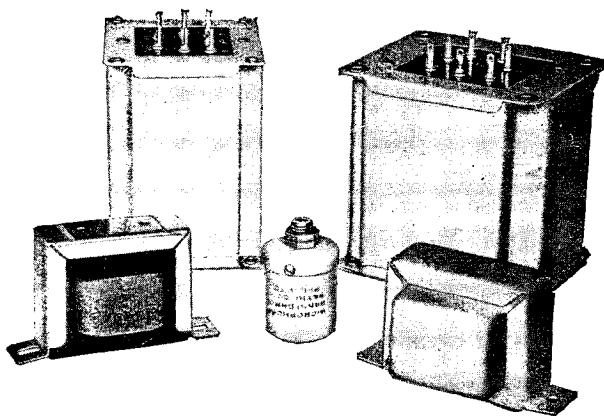

For manufacturers a very comprehensive range of open, shrouded, potted and hermetically sealed components are available in both mains and audio types.

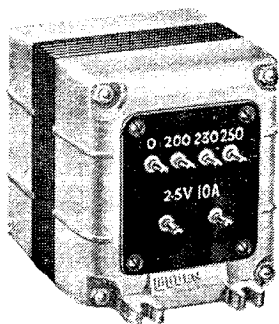

The De Luxe Transformer as shown on the left is ideal for the Amateur Transmitter and Manufacturer of communication receivers. This type of transformer is of attractive appearance and first class design.

Woden Transformers are in heavy demand for the Overseas Market. Special Types of Shrouded and Open Type components have been produced at very keen prices to enable our clients to purchase a first class product to meet world competition. Send for special Export Price List.

WODEN TRANSFORMER CO LTD

MOXLEY ROAD · BILSTON · STAFFS

TEL: BILSTON 41959.



Here are sets
to delight the expert

★ WITH 2 YEARS' FREE
ALL-IN SERVICE IN THE HOME ★

Apply any test you wish to these Sobell 5-valve superhet table receivers. You will find that every component is superbly engineered. Check the circuits, the signal rectification, the I.F. selectivity, the audio sensitivity—and any other points you like. They'll all satisfy your critical judgment.

We'll say nothing about the obvious—the pleasing cabinets, the simple controls, the easy-to-read 3 wave band tuning dials, the special gramophone pick-up sockets with automatic switches, the provision for external loudspeakers—because these are “musts” in sets designed to the highest standards.

The two models illustrated are 519P and 519W respectively, working on 200-250 volts A.C. only. There's a Sobell dealer in your district—he'll be glad to arrange a thorough demonstration.

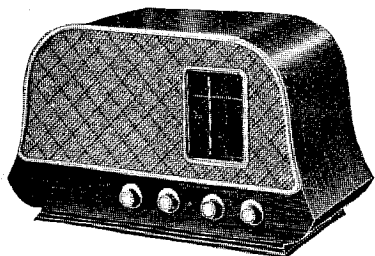

SOBELL
RADIO
AND TELEVISION

Advt. of Sobell Industries Limited, Langley Park, Nr. Slough, Bucks.

'Phone: Slough 22201/5

KOLECTRIC

AUTOMATIC COIL WINDING MACHINE

Type A1/1

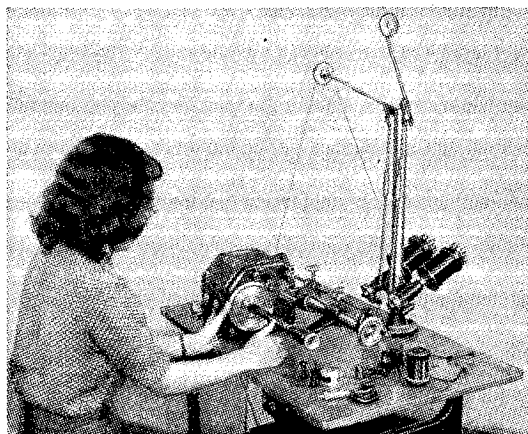

This machine is precision built and it embodies all the latest improvements in coil winding technique. It is suitable for winding coils up to 5" (127m/m) diameter and 7½" (190.5m/m) long. Minimum length of coil 7/32" (5.6m/m).

Among the many features to be found on the Type A1/1 machine are the following:—

- A clear Wire Gauge Indicator is fitted with a glass window and calibrated in mils, or millimetres, as desired. The machine can be quickly set to wind any required wire gauge .020" (.508m/m, and .001" (.0254m/m).
- For setting purposes, micrometer adjustments are provided on the trip rod. These enable the machine to be set to the required width of coil to fine limits. The wirefeed carriage automatically reverses its direction of travel when the trip rod operates.
- The railstock is fully adjustable along its bed and the centre is spring loaded to enable rapid change of the coil former.

Please write to us for illustrated leaflets A1/1, A1/2 and RT/1, which contain a full technical specification on the machine and reel stand.

KOLECTRIC

LIMITED

Dept. W

GROVE HILL, BEVERLEY, EAST YORKS.

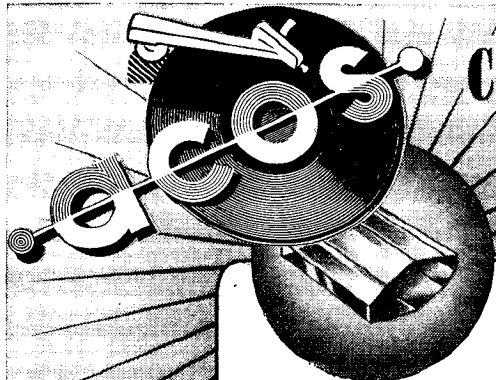

CRYSTAL DEVICES by *Cosmocord*

CRYSTAL PICK-UPS AND CARTRIDGES

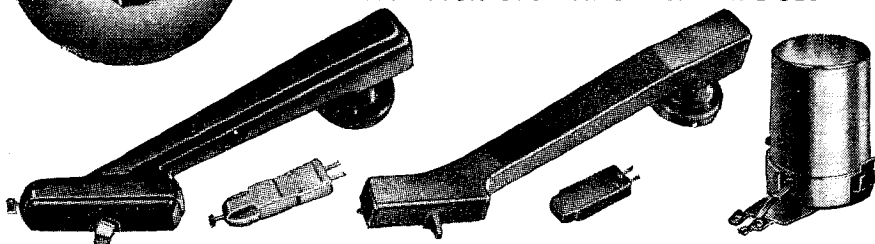

G.P. 10 with "unbreakable" crystal. Output 1.7 volts at 1,000 c/s; range 70—8,000 c/s.

G.P. 12 high fidelity model with permanent sapphire stylus. Output 1 volt at 1,000 c/s; range 30—14,000 c/s.

G.P. 15 Microcell cartridge for microgroove or standard 78 rpm recordings.

GENERAL-PURPOSE MICROPHONES



For acoustic measurements, industrial noise measurement, disc recording technique, and P.A. systems.

Type MIC 16 (illustrated)
High fidelity model with flat response from 30 to 10,000 c/s.

Type MIC 22
General purpose model with substantially flat response from 40 to 8,000 c/s.

The MAGNETIC
TYPES G.P. 6
and G.P. 7

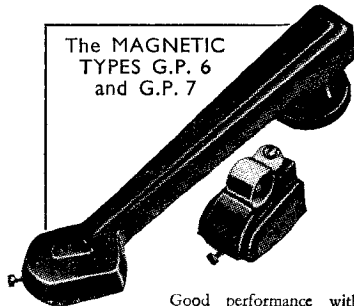

Good performance with exceptionally robust construction. Range 100—4,500 c/s.

DISC CUTTER HEADS

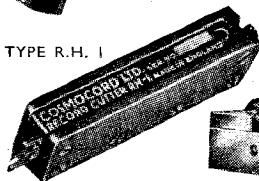

TYPE R.H. 1



TYPE R.H. 2

Good performance and modest price make it ideal for amateur recordist.

High-quality cutting head for professional use.

HEARING-AID MICROPHONES

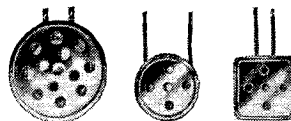

ACOS technique ensures maximum performance within minimum practical dimensions. Seven types and sizes available.

PILLOTONE "Individual" LOUDSPEAKER

For hospital or personal use, giving quality equivalent to normal loudspeaker without disturbing others.

Sole distributors of the 'Pilotone' in the British Isles, Messrs. Philips Electrical Limited.



MINIATURE EAR-PIECES

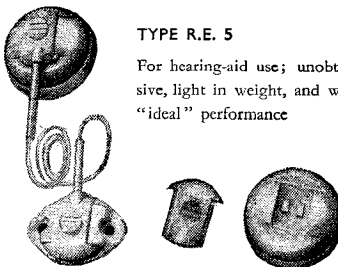

TYPE R.E. 5

For hearing-aid use; unobtrusive, light in weight, and with "ideal" performance



Stand 1723

VICTORIA "SPECIALS"

A very keen interest is taken by the technical staff at Victoria Instruments in the design and development of special-purpose instruments. This willingness to undertake the "teasers" does not surprise those who already buy Victoria products. Users of electronic measuring instruments should avail themselves of this service, and take a leaf from the book of some of the largest firms in the electronic industry.

PORTABLE TEST SETS

Robust moving iron instruments. Suitable for the Electrical Contractor or Automobile Electrical Engineer.

Size: 3½" x 3½" x 2½" overall complete with carrying strap.

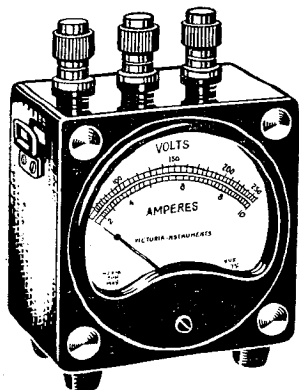

These combined instruments are made in many standard ranges. Combination examples:

260V A.C. or D.C.

15A A.C. or D.C.

25V A.C. or D.C.

25A A.C. or D.C.

Other Combinations to order

VICTORIA INSTRUMENTS

Proprietors: V.I.C. (Bournemouth) Ltd.

MIDLAND TERRACE · LONDON · N.W.10

Telephone: ELGar 7871/2

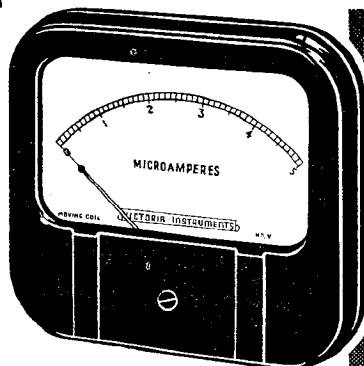

SQUARE FLANGE METERS

4" Large Open Scale. Mirror Scale can be supplied if required.

RANGES:

A.C. from 1V-10kV

25uA-100 Amps.

D.C. From 5mV-10kV

5uA-5000 Amps.

*Victoria Instruments
are made
uncommonly well*

10 Features of a Good Amplifier



- Low distortion and noise level.
- Fidelity of reproduction over the desired frequency range.
- Low output impedance to assist in reducing speaker resonances.
- Accurate matching of the audio drive to the push pull output stage.
- Negative feedback to reduce self generated distortion.
- Non-distorting tone controls with full compensation for recording characteristics.
- Sound mechanical construction.
- Reliability and constancy of performance.
- Attractive case to fit in with home furnishing schemes.
- Ease of installation.

We proudly present our Q5 Amplifier which reaches a still higher standard of high quality record and radio reproduction.

Designed primarily for use with the 'Connoisseur' pick-up, it will give superb reproduction when used with

any pick-up or radio unit capable of delivering 0.1 V.

Before despatch each amplifier is carefully tested in our laboratory, balanced for minimum distortion and supplied with all necessary cables, plugs, installation and service instructions.

A.R. SUGDEN AND CO. (ENGINEERS) LTD., BRIGHOUSE, YORKSHIRE.

The **Soundmirror** "Magic Ribbon"
offers all these Advantages

Using reels of magnetised paper—or "Magic Ribbon"—the "Soundmirror" will record and reproduce with perfect fidelity THE SPOKEN WORD; MUSIC, from a violin concerto to a full orchestra; SOUND EFFECTS of all kinds. It gives life-like tonal quality (without scratch or extraneous noises) of any desired volume equal to the best radio receivers.

Perfectly designed for simplicity of operation—you can't go wrong—one single finger tip control provides for play—record—rewind or fast forward requirements. The "Soundmirror" Recorder is a complete electronic unit—contains speaker, amplifier, microphone and is equipped with jacks for easy hook-up to radio, public address and other electronic audio systems.

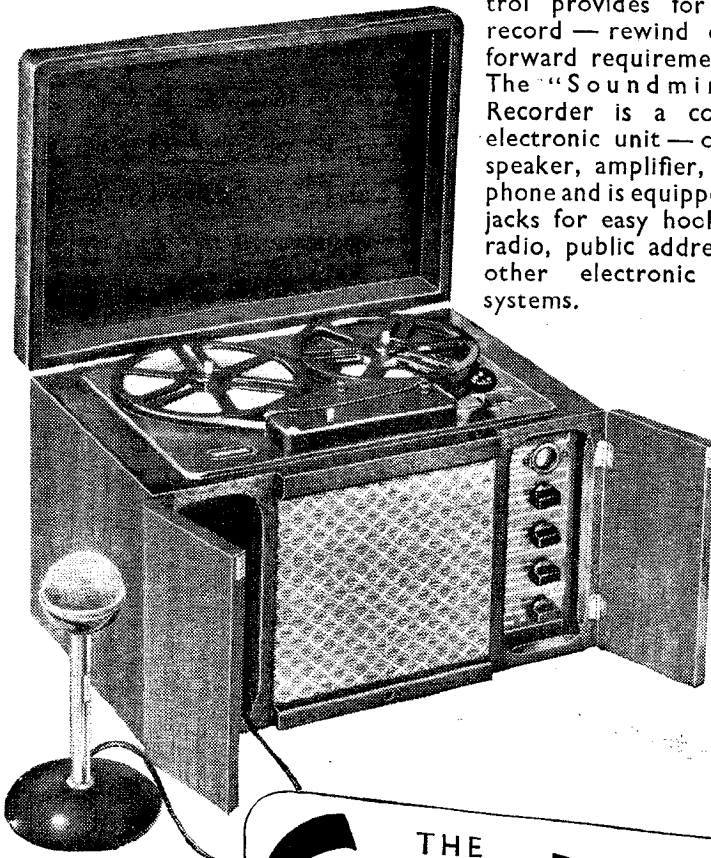

THE
Soundmirror
MAGNETIC TAPE RECORDER

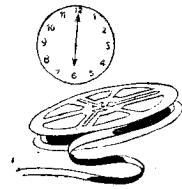

"Soundmirror" gives a full unbroken half-hour's recording on every reel of "Magic Ribbon."

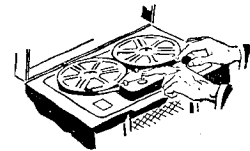

"Soundmirror" "Magic Ribbon" can be erased and used an indefinite number of times. Erasure is accomplished automatically whenever a new recording is made.

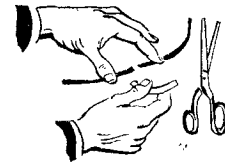

"Soundmirror" "Magic Ribbon" can be cut and spliced—short recordings joined together—unwanted parts removed. The unwanted portions can be erased and used again.



"Soundmirror" "Magic Ribbon" is easy to handle—it does not become coiled or tangled. Easy to handle—easy to thread—easy to store.

Protected by British & Foreign
Patents & Patents Pending

THERMIONIC PRODUCTS LTD. LEADERS IN THE FIELD OF MAGNETIC RECORDING

Head Office: Morris House, Jermyn Street, Haymarket, London, S.W.1

Telephone: Whitehall 64223/4



DIRECT RECORDING DISCS

These cellulose lacquer aluminium discs are unequalled for their high performance — a frequency range extending to well above 10 Kc/s is easily recorded and reproduced. They consistently permit efficient cutting over a range of ambient temperatures of from 0°C. to 60°C. Used by leading broadcasting stations, film studios, private and commercial recording studios. Can be stored indefinitely either blank or recorded.

CURRENT LIST PRICES

- 5 in. Double Sided 1/6d.
- 6 in. Double Sided 2/0d.
- 7 in. Double Sided 2/6d.
- 8 in. Double Sided 3/0d.
- 10 in. Double Sided 4/6d.
- * Single Sided 3/8d.
- 12 in. Double Sided 6/6d.
- * Single Sided 5/3d.
- 13 in. Double Sided 8/9d.
- * Single Sided 7/9d.
- 16 in. Double Sided 14/6d.
- * Single Sided 11/0d.
- 17½ in. Double Sided 17/6d.
- * Single Sided 13/6d.

* When available.

MASTER RECORDINGS FOR PROCESSING

M.S.S. Discs are ideally suited for recording "Masters" for processing. "Over-size" discs are necessary — for pressings 16", 12", 10" diam. use discs 17½", 13", and 12" diam. respectively.

M.S.S. RECORDING COMPANY LTD.
POYLE CLOSE, COLNBROOK, BUCKS., ENGLAND

E.H.T.

FROM LINE FLY BACK

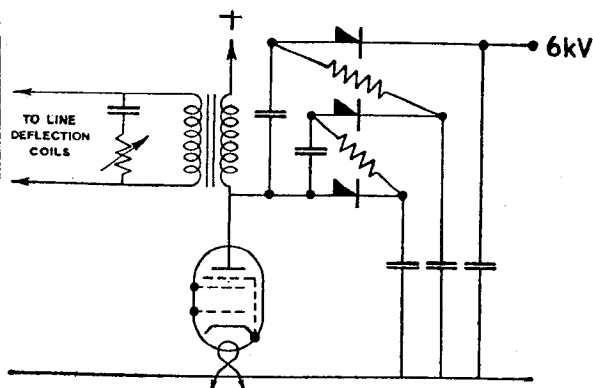

Tripler circuit using

WESTINGHOUSE
WESTALITE
TYPE 36EHT35
RECTIFIERS

Peak pulse input approximately 2,500V.
Output approximately 6kV at 100 micro-amperes.

Simple . . . efficient . . . and reliable

Write for data sheet No. 60, to Dept. W.W.6

WESTINGHOUSE BRAKE & SIGNAL CO., LTD.

82 YORK WAY, KING'S CROSS, LONDON, N.1

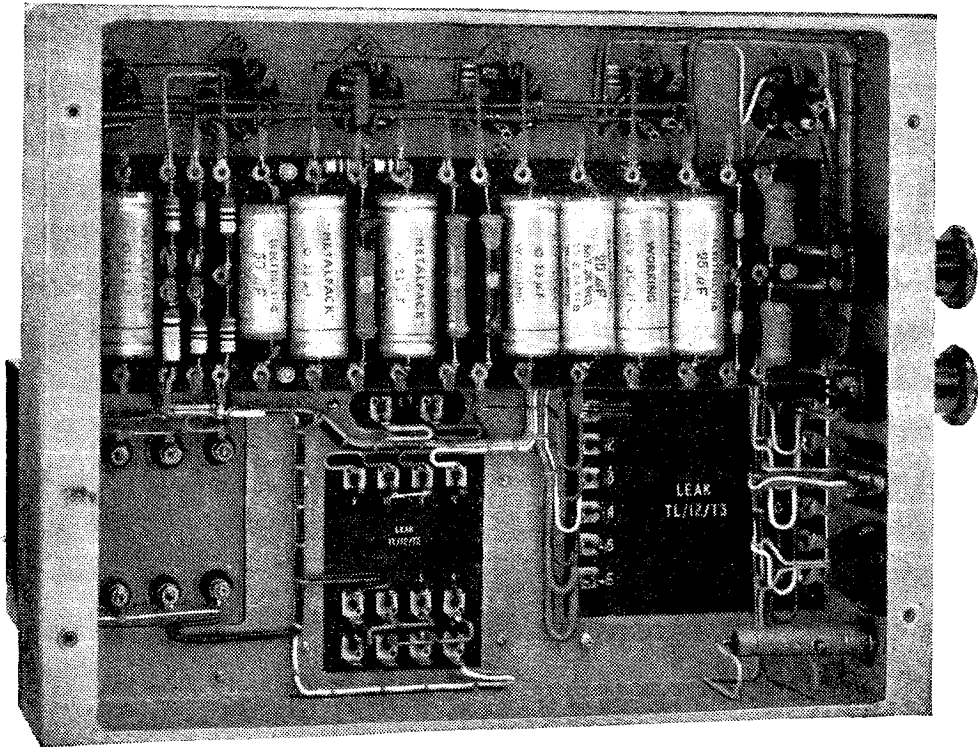

UNDER CHASSIS VIEW OF THE TL/12 POWER AMPLIFIER

LEAK equipment is built to laboratory standards in materials and workmanship by experienced men.

REMOTE CONTROL PRE-AMPLIFIER RC/PA

£6 - 15 - 0 list.

An original feedback tone-control circuit which will become a standard.

No resonant circuits employed.

- Distortion : Less than 0.05%.
 - Switching for Pick-up, Microphone and Radio, with automatic alteration of tone-control characteristics.
 - High sensitivities. Will operate from any moving-coil, moving iron or crystal P.-U.; from any moving-coil microphone; from any radio unit.
 - Controls : Input Selector ; Bass Gain and Loss ; Treble Gain and Loss ; Volume.
- Output Impedance : 0-30,000Ω at 20 kc.p.s.

The unit will mount on motor-board through a cut-out of $1\frac{1}{8}$ in. \times $3\frac{3}{8}$ in., or it can be bolted to the power amplifier, when, with a top cover, the whole assembly becomes portable.

For use only with LEAK amplifiers.

Used with the RC/PA pre-amplifier and the best complementary equipment the TL/12 power amplifier gives to the music-lover a quality of reproduction unsurpassed by any equipment at any price. It is designed in a form so that the power amplifier can be housed in the base of a cabinet and the small pre-amplifier mounted in a position best suited to the user. If you would like to know more about amplifiers in general, and the TL/12 and RC/PA in particular,

WRITE FOR BOOKLET W/TL/12.

H. J. LEAK & CO. LTD. (Est. 1934)

BRUNEL ROAD, WESTWAY FACTORY ESTATE, ACTON, W.3.

Phone : SHEpherds Bush 5626.

Telegrams : Sinusoidal, Ealux, London.

Foreign : Sinusoidal London.

TL/12 12W. TRIPLE LOOP POWER AMPLIFIER

£25 - 15 - 0 list.

A Leak triple loop feedback circuit, the main loop giving 26 db. feedback over 3 stages and the output transformer.

- Push-pull triode output stage. 400 V. on anodes.
 - No H.T. electrolytic smoothing or decoupling condensers.
 - Impregnated transformers; tropically finished components.
 - H.T. and L.T. supplies for pre-amp. and radio units.
 - Distortion : at 1,000 c/s and 10 W. output, 0.1% ; at 60 c/s and 10 W. output, 0.19% ; at 40 c/s and 10 W. output 0.21%.
 - Hum and Noise : -80 db. on 10 W.
 - Frequency response : ± 0.1 db., 20 c/s-20 kc/s.
 - Sensitivity : 160 mV.
 - Damping Factor : 20. Input impedance : 1 MΩ.
- Output impedances : 2Ω ; 7-9 Ω ; 15-20 Ω ; 28-36 Ω. Phase margin $20^\circ \pm 10^\circ$. Gain margin 10 db \pm 6 db.

25 W. model available at £27.10.0.



It's got to be good

The heart of a Vibrator Power Unit (which supplies H.T. Current from low power D.C.) is the vibrator itself. Unless that gives a first class performance and goes on giving it for many, many hours, you have a heap of trouble on your hands. Hence the popularity of the "Wimbledon" Vibrator among many well known radio and electronic engineers. We have done a great deal of work on this Vibrator and we think it is just a little better than any other you can get. We are producing both synchronous and non-synchronous Vibrators and a complete range of Vibrator Power Units. Write for full details and judge them for yourself.

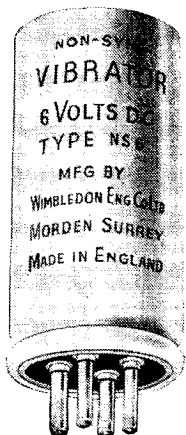
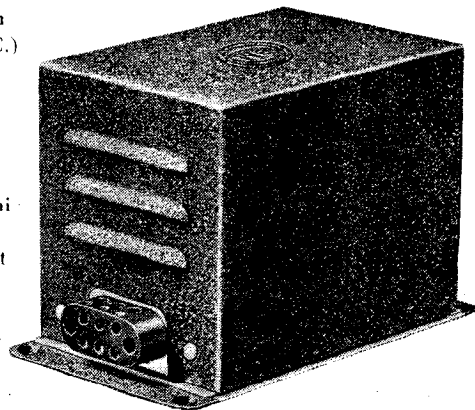

WIMBLEDON

ENGINEERING COMPANY · LTD

GARTH ROAD · LOWER MORDEN · SURREY · TEL.: DERWENT 4814, 5010

CRC3



The Radio Builder

For many years Ritherdons have kept chappies like this happy by supplying the metal parts with which to tinker!

But, it isn't only the amateur that knows Ritherdons. Apart from wireless chassis, metal stands and cases, they specialize in sheet metal work, especially for electrical equipment and Radio & Television. All work can be enamelled or electro-plated before leaving the works because Ritherdons are fully equipped for this work too. Seek their expert advice; enquiries will receive prompt attention.

RITHERDON & CO LTD

LORNE STREET, DARWEN, LANCs. Phone: Darwen 1028

SPECIAL OFFERS!

TYPE RF26 U.H.F. CONVERTER UNIT. Needs no modification, covers 50-60 mc/s. Can be used with any superhet covering 7.5 mc/s (40 metres). Supply required 6.3 v. 1 amp. hrs., 250-300 v. 30 mA H.T. 3 stages, R.F., mixer, osc., all tuned. All parts and chassis silver plated. Muirhead S.M. drive. Connections external. Ideal for 5-metre band or Birmingham Television. PRICE 35/-, postage 1/4.

TRANSMITTING VALVES. Brand new and boxed. Type 830B, 25/-; 832, 25/-; 832A, 25/-; 807, 8/6; 866/866A, 25/-; 805, 45/- . Also complete sets brand new R.C.A. Valves for A.R.88 Rx. Price £6 10s. 0d.

CHOKES

Heavy duty, fully shrouded in cast aluminium rectangular "Pots." (These are 200 mA, 262 mA and 300 mA amateur rating.)

30 hy. 100 mA 150 ohms (wt. 14 lbs.). Price 20/-, postage 2/6.

20 hy. 126 mA 100 ohms (wt. 14 lbs.). Price 22/6, postage 2/6.

30 hy. 150 mA 150 ohms (wt. 18 lbs.). Price 25/-, carriage 5/-.

R.F. Chokes, pie wound. 2.5 mH 100 mA Rx type, 1/6; 2.5 mH 250 mA Tx type, 1/9.

CONDENSERS. Midget tuning, 1/4 in. spindle, ceramic end plates, panel mtg. Code P20 20 mfd. double spaced, 2/- . Code P50 50 mfd. single spaced, 2/6. Code P100 100 mfd. single spaced, 2/9. Ditto two-wang or split stator code 2P6.5 2 x 6.5 mfd., 3/- . Code 2P11 2 x 11.0 mfd., 3/6.

Midget Trimmers. Double spaced ceramic end plates as type P20. Code T20, 20 mfd., 2/- . Code T50, 50 mfd., single spaced, 2/6. Code T100 100 mfd., single spaced, 2/9.

CONCENTRIC CABLE for transmission line, dipole antennas, and ideal for television equipment. Average impedance, 72 ohm., 1/4 in. dia., 1/6 yd. : 1/4 in. dia., 1/2 yd.

RIBBON FEEDER for folded dipoles, 300 ohm heavy duty low-loss twin lead. Price 2 1/2 d. per foot.

Numerous other bargains are now available. Send 3d. in stamps for No. 8 Special Offers list and Raymart new illustrated catalogue "V.V."

RADIOMART

GENI (GRAM) LTD.

48, HOLLOWAY HEAD, BIRMINGHAM, I.

Tel. : Midland 3254.

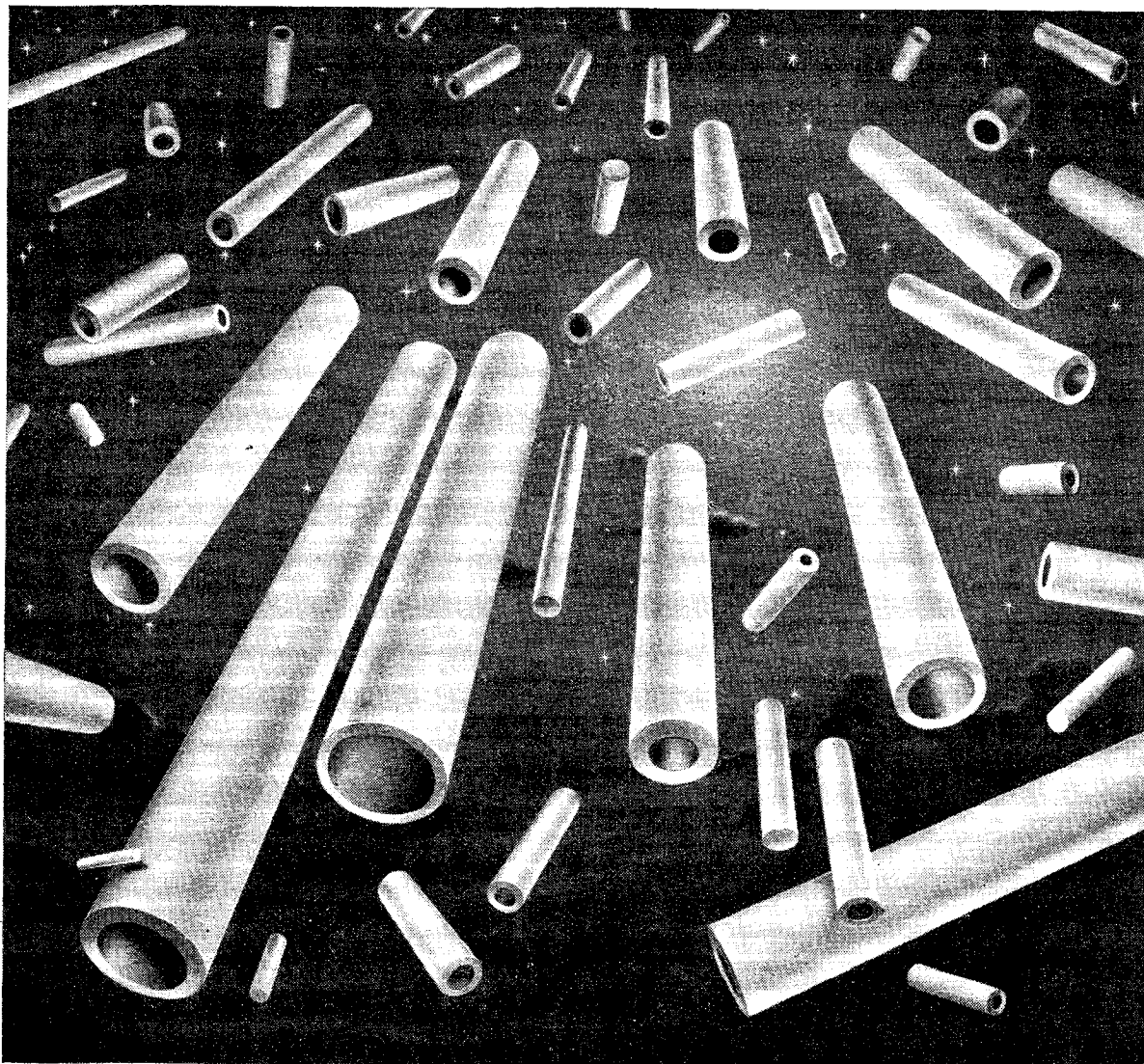

CERAMICS

FOR RESISTORS

and all radio components

FREQUENTITE — FARADIX — TEMPRADIX

STEATITE & PORCELAIN PRODUCTS LTD.

Stourport on Severn, Worcester

Telephone: Stourport 111

Telegrams: Steatoin, Stourport



the 'TOPS' in TELEVISION

Aerialite Television Aerials are being installed as fast as they can be produced. Good technical design, ease of fitting and robust construction, are all strong points of the entire Aerialite range. For clear, sharp, steady pictures with never a "ghost", Aerialite, the television aerial for all circumstances, is the name to remember. Send for illustrated booklet giving full details.

Sell

AERIALITE
TELEVISION AERIALS
and EQUIPMENT

for the
Pictures at Home



Made by AERIALITE LTD., STALYBRIDGE, CHESHIRE

The very latest AUTOMATIC RECORD PLAYER

has no gadgets
and switches

Extremely simple to operate, this new automatic Record Player has been designed for maximum efficiency and embodies many special refinements. Easy to load and unload, the machine will play eight 10" and 12" records, mixed together if so required. Record changing takes only 4½ seconds and any record can be repeated by a touch of the control knob. This is the only switch on the instrument and it is used for stopping and starting, loading and unloading and repeating or rejecting records.



FROM GOOD
RADIO DEALERS

This model will shortly be available
with High Fidelity Pick-up for
7/- extra.

Made and Guaranteed by

RETAILS AT
£19 · 10 · 0

Plus Tax

with crystal or magnetic
pick-up.

OTHER MODELS FROM
8 GUINEAS Plus Tax.

Richard Allan RADIO
LTD.

CALEDONIA ROAD, BATLEY, YORKS.
Makers of the famous "Baffle" Extension Speakers.

THE NEW "75" SIGNAL GENERATOR Model 1

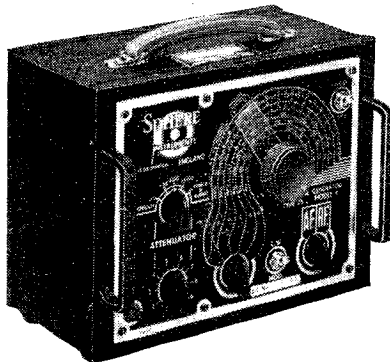

Frequency Range
110 to 50 Megacycles.
With calibrated extension covering London, & Midland Television frequencies, at over 60 Megacycles.

Modulation
400 C.p.s. sinusoidal.

Attenuator
5-step ladder, with fine control.

Output
Switched via single rest-lead, RF. and AF.
1 volt Max.

External Radiation
Less than 1 micro-v.

For A.C. mains operation. Complete with Standard Dummy Aerial.

SPHERE LIST **12½** GNS.
INSTRUMENTS SUBJECT.

EXCELLENT PERFORMANCE
ATTRACTIVE APPEARANCE
LOW PRICE
HIGH EFFICIENCY

INQUIRIES INVITED:

SPHERE RADIO LIMITED
HEATH LANE, WEST BROMWICH, ENGLAND

There's a purpose right before us

“Why not work a little faster?”

Says Sir Stafford to us all,

“There's a purpose right before us,

PRODUCTIVITY's the call.”

See how eagerly DESOUTTER Tools

on bottlenecks advance!

They are waiting on your signal—

—give each Little Horse his chance!

Will you, won't you, will you

give each Little Horse his chance?

Will you, won't you, WON'T YOU

give each Little Horse his chance?

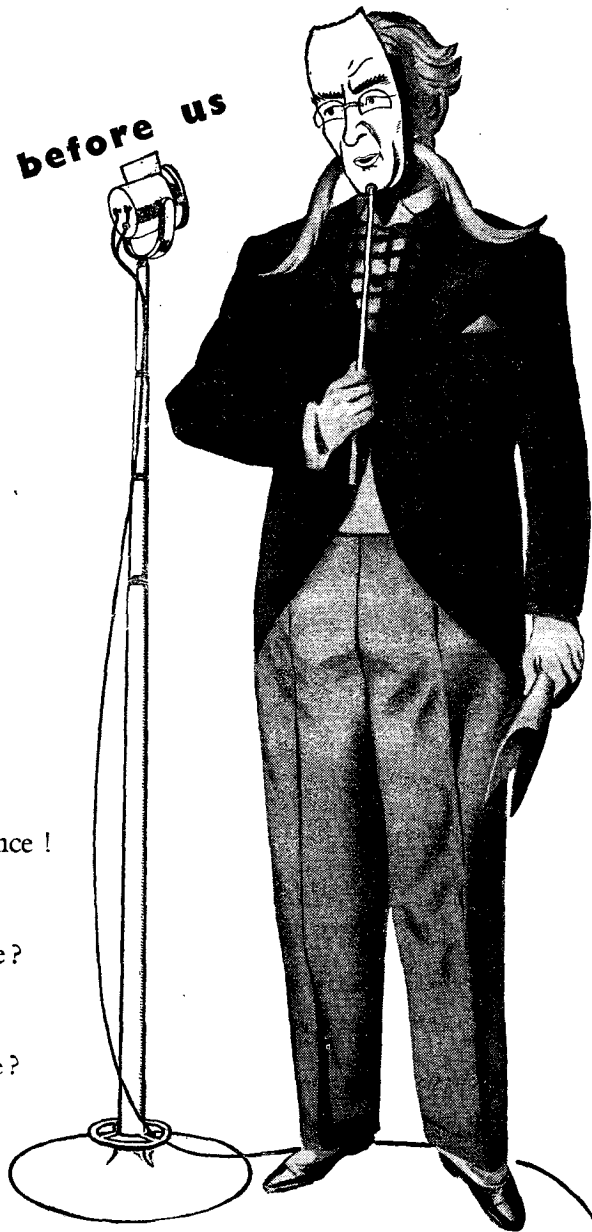

Call up DESOUTTER'S Little Horses

Specialists in Lightweight Pneumatic and Electric Portable Tools.

DESOUTTER BROS. LIMITED, THE HYDE, HENDON, LONDON, N.W.9. TELEPHONE: COLINDALE 6346-7-8-9. TELEGRAMS: DESPNUCO, HYDE, LONDON
CRC203

let "Mighty Midget"

Boost Your Sales

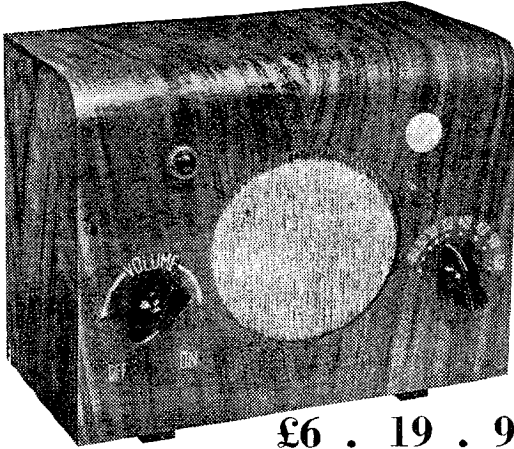

£6 . 19 . 9

INC. P.T.

GENERAL SONIC INDUSTRIES

(Formerly General Electrical Radio)

21-29 SHENE STREET, BATH STREET, LONDON E.C.1

- 3 valve, plus rectifier, midget radio receiver; 200-250 volts A.C. or D.C.
- **Cabinet:** Fully seasoned wood, finished in polished walnut
- **Valves:** Latest British Octal and Ballast Type
- **Coils:** High "Q" iron cored on "low-loss" formers
- **Wave-range:** 200-550 metres
- **Chassis:** Steel, plated for reliability & long life
- **Loudspeaker:** 5" dia. "Monobolt" construction, to which is fed 3 watts of Audio Power
- **Guarantee:** 12 months
- Apart from Mains, the only connection is an aerial supplied with the set

Volume, Tone and Sensitivity are remarkable from a Radio measuring 8½" x 7" x 4½". The advertising campaign now getting into its stride, will be increased in volume and tempo, as space becomes available

Dependable Di-electrics

OKERIN waxes

and DI-JELLS

—for insulating, filling, impregnating, waterproofing, sealing and finishing radio and electrical components, cables, etc.

ALL GRADES ARE DESIGNED TO MEET DEFINITE CHEMICAL, PHYSICAL AND ELECTRICAL STANDARDS.

For technical advice and samples, phone
TEMPLE BAR 5927.

Sales Department

ASTOR BOISSELIER & LAWRENCE LTD
NORFOLK HOUSE, NORFOLK STREET, STRAND, W.C.1

Works and Laboratories: West Drayton, Middlesex.

M.R. SUPPLIES Ltd.

offer the following reliable Public Address and Laboratory equipment for immediate delivery from stock. All prices nett.

P.A. SPEAKERS, m/coil pressure type P.M. Units, 15 ohms coil, with 600-ohm line multi-matching transformer, in weatherproof housing, handling 10-watts, standard P.A. thread, ¾in. (18 t.p.i.). Best makes, reconditioned as new, 59/6. Projector Horns, to suit:—30in. square type Dispersive Horns, all metal, 45/6. (despatch 3/6) or the Unit and Horn complete for 45/6- (curr. paid U.K.). Also 42in. all-metal exponential Horn, brand new Gramoin, 25 (unpainted) and 25/10/- (sprayed grey) (des. 4/6). These will also fit above units. **STEEL TRIPODS** for P.A. Speakers, extending to 12ft., adjustable height, sturdy rigid type for all weather conditions, 55/- (des. 5/-).

FRACTIONAL MAINS MOTORS. 200/250 v. A.C. Brand new, shaded pole. Running torque 400 gram/ems., 1,200 r.p.m., 100% starting torque. Silent in operation. Shaft 1in. long by ¾in. Frame 3½in. by 2½in., 32/6. (It should be noted that these are motors designed for mains use, not the inefficient "conversion" types generally offered).

AIR COMPRESSORS, the best type with 12 steel cooling fins, total length 8in. 400 lbs., per sq. in. 6-key splined socket drive, 25/- (des. 1/6).

A.C. MAINS CONTACTORS. Coil 230 v. 50 c. Contacts 3-pole each 10 amps, supplied with these wired in parallel for 30-amp switching. Smart action, silent in use. On panel 6in. by 4½in. with cover, 17/6.

MINIATURE RELAYS. Note the very small dimensions: 1½in. by ¾in. Switching two single-pole change-over (paired contacts, platinum) Resistance 65 ohms, type 10F/2724, 7/6 each. Special price for quantities.

DECADE RESISTANCE BOXES (by best precision makers) Units 0/10, Tens 0/100, with additional 100 ohms. Fitted m/coil Galvo, switching for Wheatstone Bridge and other tests, in fine portable case, 16in. by 7½in. by 6in., 65/- (des. 2/-).

CAMBRIDGE THERMO-COUPLERS for instruments. Rated 5 m.a. (max 10 m.a.). With standard 4-pin cube cap. Boxed, with test-data label, 7/6.

MILLIAMMETERS, very special offer of 0/20 m.a. 2½in. proj. type., high-quality m/coil, ex-Govt., Brand new, 6/6. Also 2½in. flush, 0/150 m.a. m/coil, same price Here is a real opportunity.

BLOWERS, 12/24 A.C./D.C. (tapped). Inlet and outlet approx. 1½in. dia. Overall length 6½in. Very powerful blast. With mounting bracket, 27/6. Transformers specially made for use with the Blowers, enabling them to be used on 200/220/240 v. A.C. mains, 22/6.

ELECTRIC WATER PUMPS. Brand new, immersion, self-priming. Approx. 18in. long and 2in. dia. with adjustable mounting flange. The impeller is driven by a precision motor within the tube. Delivery over 300 g.p.h. Operation 12/24 v. A.C./D.C. 29/6. Or with Transformer specially made to enable the Pump to be used on 200/220/240 v. A.C. mains, 47/6 complete (des. 2/-).

Also the well-known **Stuart Electric Water Pump,** operation 220/250 v. A.C./D.C. Soudly constructed of non-ferrous metals for exposure and long life. No. 10 (120 g.p.h.), 25/15/- (des. 2/-). No. 12 (600 g.p.h.), 28/10/- (des. 3/6). Supplied with instructions and makers' guarantee.

SYNCHRONOUS ELECTRIC CLOCK MOVEMENTS, 200/250 v. 50 c. Spindles for hours, minutes and seconds hands. Single-hole mount, silent running.

Supplied with plastic dust cover, 2½in. dia., 2in. deep, and flex. ready for use, 37/6 Set of three hands to fit, suitable for 5-in. dial 2/- (Not sold separately). Please include sufficient for packing/despatch. Our new List of Variable Resistances and Dimmers is now ready.

M. R. SUPPLIES Ltd., 68, New Oxford Street, London, W.C.1

Telephone: MUSeum 2958

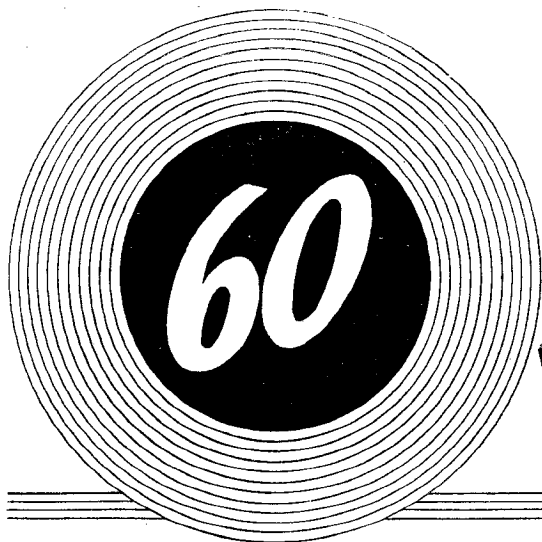

'CINTEL' Photo-Electric Cells

The most comprehensive range of Cells in the World...

Available with three types of cathode surfaces :—

TYPE A—Antimony-Caesium. (British Patent No. 522,752 1938). Sensitive to blue light and daylight.

TYPE B—Bismuth etc.—Caesium. Sensitivity similar to human eye.

TYPE S—Silver-Oxygen-Caesium. Red - infra - red sensitive.

Cells for use in the ultra violet region of the spectrum • Cells of high insulation, linearity and stability for accurate photometric work • American type equivalents • Push-Pull types for double sound tracks • Special cells for dye image sound tracks, multipliers, etc. *Please write for catalogue.*

Sixty different types of Photo-Electric Cells

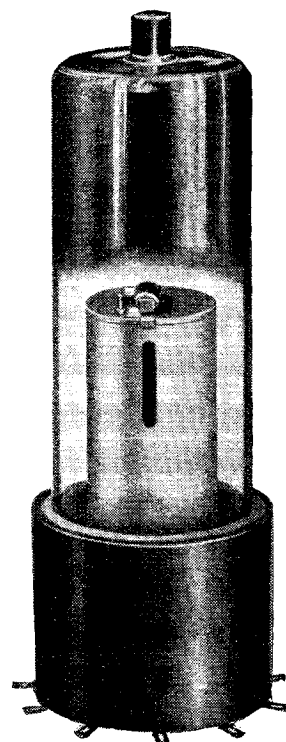

—from miniature to multiplier—



Registered Trade Mark

FOREMOST IN THE MANUFACTURE OF

- COUNTERS & CHRONOMETERS
- METAL DETECTORS
- OSCILLOSCOPES
- PHOTO-ELECTRIC CELLS
- CATHODE RAY TUBES
- GEIGER-MULLER TUBES
- ELECTRONIC INSTRUMENTS

CINEMA-TELEVISION LIMITED

WORSLEY BRIDGE ROAD, LONDON, S.E.26

Telephone: HITHer Green 4600

The
MAGNAVISTA
TELEVISION LENS

WITH A
VIEW
TO
PERFECTION

Magnavista consulted eminent independent authorities on lens computation at every stage in the design and manufacture of their latest Television Lens. The result is a product as near perfection as human skill and ingenuity can make it... a lens which offers:-

**HIGH MAGNIFICATION
FREEDOM FROM DISTORTION
WIDE VIEWING ANGLE
AMAZING BRILLIANCE
AND
NO DISCOLOURATION**

When it is possible to make a better lens, Magnavista will make it. Until then, the more critical you are the more important it is that you should insist on Magnavista. There is a model for every Television Set.

PRICES

TYPE	Tube	£ s. d.
A.7	6"	3 3 0
A.1, A.2, A.4, A.5	9"	4 14 6
B.1, C.1...	10" & 12"	5 5 0
D.1	15"	5 15 6
A.3 (Universal)..	9"	6 16 6
B.2 (Universal)..	10"	7 7 0

*MAGNAVISTA Magnification
is Television Perfection*

METRO PEX LTD

38, Gt. Portland St., London, W.1
(Phone: Museum 9024-5)

from the range of  instruments

Model 44 SUBSTANDARD
MULTI-RANGE METER

A self-contained precision instrument for general laboratory use and for calibrating first grade single and multi-range meters. The accuracy on the 44 ranges is Substandard on d.c. and within $\pm 0.5\%$ on a.c. These meters are made with the greatest care and have been supplied for a number of years to the leading laboratories at home and abroad.

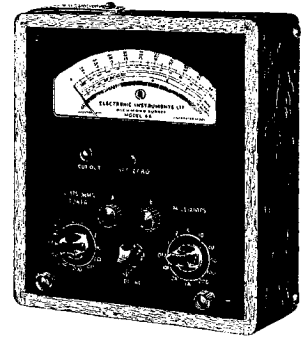

ELECTRONIC INSTRUMENTS LTD
17 PARADISE ROAD · RICHMOND · SURREY



**"You're CERTAIN to get
it at ARTHURS !"**

★ **VALVES** : We have probably the largest Stock of valves in the country. Send your enquiries. We will reply by return.

PICK-UPS. DECCA £6 14 6. Decca head for Garrard £4 11 0. Adaptors 5/-. Connoisseur £4 11 0.

REMINGTON FOURSOME SHAVERS
210-250 v. AC/DC. Also for 110 Volts £7 17 6.

ALL DENCO PRODUCTS IN STOCK
Maxi Q Coils and Turret Units

For Television :
Deflection Coil Assembly £1 10 0.
Line Output Transformer with screening can £1 7 0.
Focus Coil Assembly..... £1 5 0.

ALL AVO AND TAYLORS METERS. List on request
ALSO STOCKISTS OF ALL DOMESTIC APPLIANCES
London's Oldest Leading Radio Dealers.

Arthur's EST. 1919
PROPS: ARTHUR GRAY. LTD. Terms C.O.D. or cash with order.

Our Only Address **Gray House, 150, Charing Cross Rd., London, W.G.2** Temple Bar 5833/4
ELECTRICAL TELEVISION & RADIO ENGINEERS.

NINE EXAMPLES

from the
"FLEXILANT"

(RUBBER BONDED
TO METAL)

RANGE
of
MOUNTINGS

•
OBTAINABLE
FROM STOCK

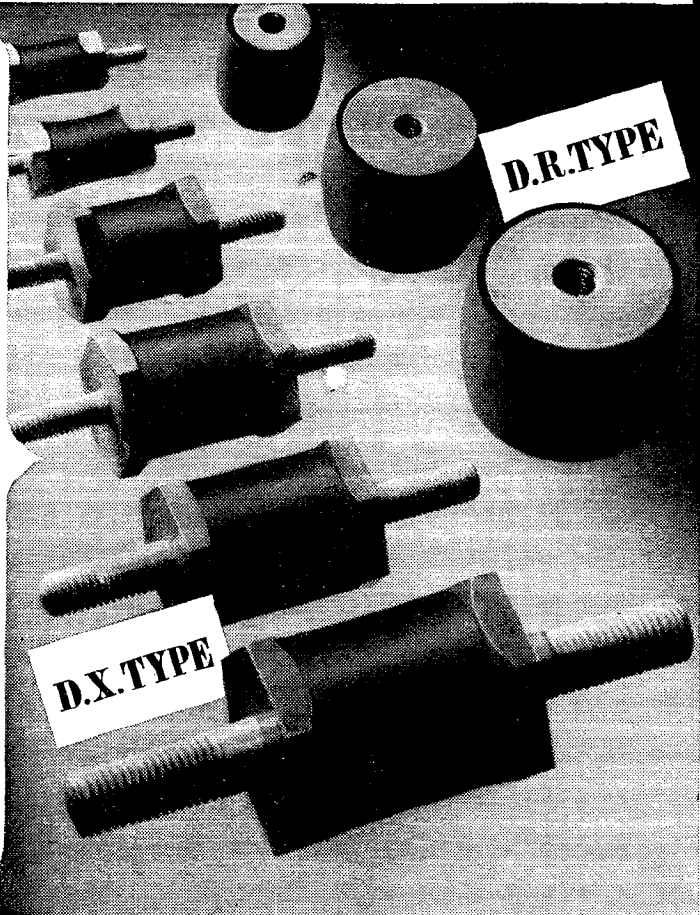

OUR TECHNICAL STAFF investigates
all mounting problems
May it investigate yours?



RUBBER BONDERS LIMITED

ENGINEERS IN RUBBER BONDED TO METAL

FLEXILANT WORKS

DUNSTABLE · BEDS.

TELEPHONE DUNSTABLE 803-15

You simply MUST make a WIRE RECORDER

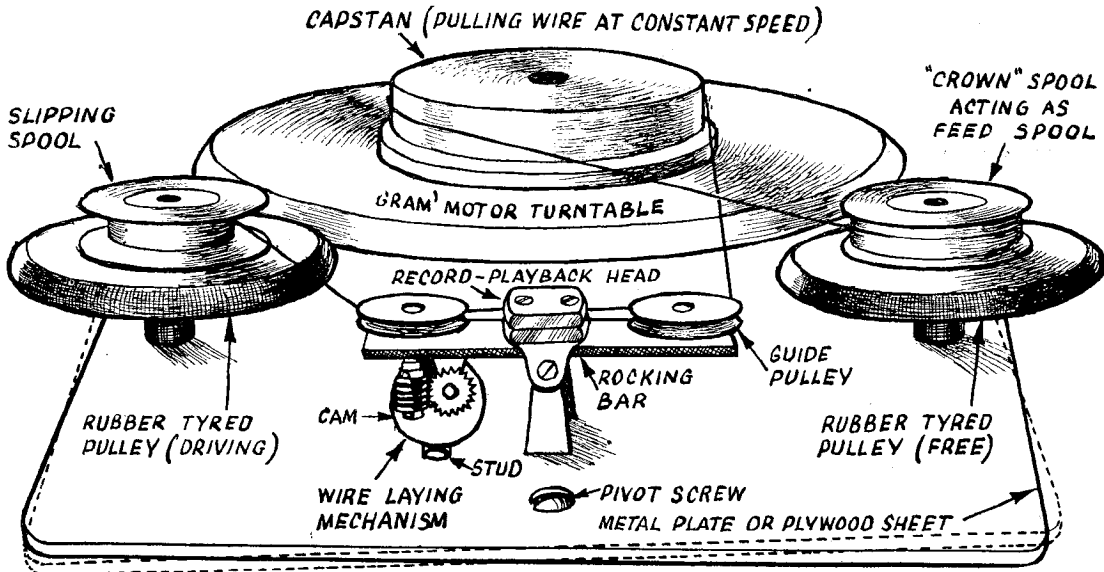

More thrilling than Radio—More gripping than Television. Complete constructional "Gen," 5/-.
All Components in stock. DEMONSTRATIONS BY APPOINTMENT.

PARK RADIO 676-8, Romford Road, London, E.12 'Phone: ILFORD 2055

You'll find the gear you need at THE RADIO CENTRE

... and what's more—at prices you can afford. We've a huge selection of radio and electrical equipment on show. Come and look round.

VOLT-OHM MILLIAMMETERS
A huge purchase of brand new portable testing instruments enables us to offer these very useful general purpose meters at a very low price. Ranges 0-500, 0-5000 ohms; 0-6, 0-60mA, 0-1.5V; 0-3V; includes also unique "ON LOAD" primary cell tester. In black plastic case, size 3½" x 3½" x 2½". Instructions included. May also be used as Foundation Meter. 2½" dial. Scale length 3". Fitted with shoulder straps. Only 15/- Post Free.

TWIN 24v. VOLTAGE REGULATORS
Type F. complete with carbon piles, rheostats and selenium rectifier, etc. Special offer, 10/- Post Free.

ROTARY TRANSFORMERS
6v. or 12v. D.C. input.
250v. 50mA or 480v. 40mA output.
New and Boxed.
Bargain offer at 15/- Post Free.

U. S. A. TUNING UNITS
To callers only at our new show-rooms. TU8B, TU9B, TU10B,

M.O.S

MAIL ORDER SUPPLY CO., THE RADIO CENTRE
33 Tottenham Court Road, London, W.1. Tel.: MUSeum 6667/8/9.

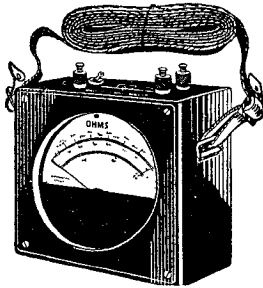

TU26B. All as new. Come and get one NOW! 5/- only.

14' COPPER TUBE AERIALS
In 7 interlocking sections folding down to 2 ft. Complete with aerial base fitted with terminal and fixing base. 10/- Post Free.

2v. 20 AH. R.A.F. ACCUMULATORS
Brand new and unused. Only 7/6d. (Plus post & packing 2/6d.)
Terms: Cash with order.

M.O.S. NEWSLETTER
A vitally alive Radio Fan's bulletin. Send 6d. for specimen copy or 5/- for one year's subscription.

An Important Control Device,
AT LAST AVAILABLE COMMERCIALY

Ultra-Sensitive THE Labgear ELECTRONIC RELAY

FOR
PRECISION TEMPERATURE CONTROL
LIQUID LEVEL CONTROL
GAS OR LIQUID PRESSURE CONTROL
HUMIDITY CONTROL
AND MANY OTHER APPLICATIONS

All the above require a relay which will operate on negligible current and which does not give rise to sparking at the control contacts.

THE Labgear ELECTRONIC RELAY

- OPERATES FROM ONLY 20 MICRO-AMPERES AND WILL CONTROL 1 KILO-WATT OF POWER.
- IS ROBUST AND INSENSITIVE TO SHOCK.
- HAS BUILT-IN AMPLIFIER AND POWER UNIT FOR OPERATION ON STANDARD A.C. MAINS.
- IS COMPACT, LIGHT, AND RELIABLE.
- YET SELLS COMPLETE AND READY TO OPERATE AT £4-4-0.

GRAMS: **Labgear Ltd.** 'PHONE: CAMBRIDGE
LABGEAR WILLOW PLACE, 2494
CAMBRIDGE CAMBRIDGE

Something **NEW** in amplifiers

THE
Nocturne

THE SMALLEST 8-VALVE HIGH-FIDELITY AMPLIFIER IN THE WORLD

Charles Amplifiers Ltd. are proud to announce a great new advance in amplifier design. The 'Nocturne' is the smallest high-fidelity amplifier of its type yet offered to the public, and the first to use miniature valves. Its full-sized rectifier gives a wide margin of safety, and the full-sized output valves ensure distortionless reproduction. It is designed primarily for moving coil or miniature moving iron pick-ups or moving coil microphone, and its 8-valve circuit is based on the highly popular "Concerto." Separate bass and treble controls ensure complete control of tonal balance. The handsome metal case eliminates the usual 'laboratory' look and sockets for tuning unit, H.T. and L.T. are fitted. 6 watts output.

Size : 9½" high x 6" wide x 8" deep. Price £23.0.0

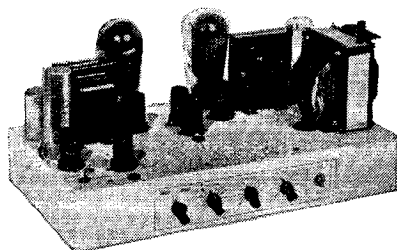
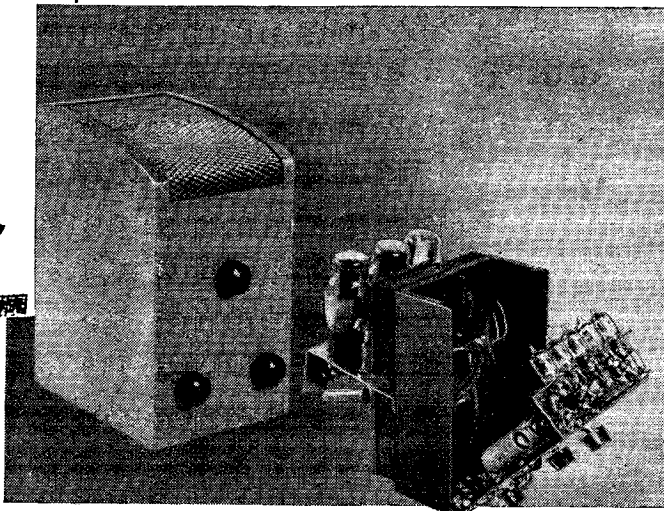

THE CONCERTO AMPLIFIER

The most famous high-fidelity amplifier for home or music society. Designed for moving coil or miniature moving iron pick-ups. Price £27.10.0 Dust cover with bottom plate, 37/6 extra. Delivery by passenger train carriage paid. A deposit (returnable) of 10/- is charged for the crate.

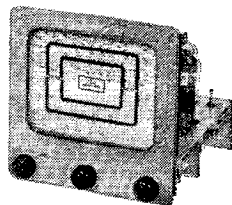

THE R.A. TUNING UNIT

A really fine design with lasting high performance. R.F. stage on all wavebands. High-fidelity superhet or T.R.F. performance. Suitable for any amplifier and ready to plug into our amplifiers. Price 13 Gns., plus £3.0.8 tax.

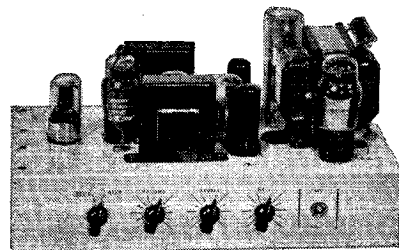

THE K.I. AMPLIFIER

A seven-valve amplifier especially designed for the light-weight high-fidelity type pick-up. Independent bass and treble controls. Price complete 17 Gns. or in kit form 13 Gns. Blueprint available separately, 2/6.

ALL INSTRUMENTS ARE GUARANTEED FOR TWO YEARS
"LIVING MUSIC"—a fully illustrated catalogue of all our amplifiers and tuning units. Write for your copy to-day, enclosing 5d. in stamps.



THE TRICORNE SPEAKER CHAMBER

For optimum acoustic performance with any good 12-inch speaker. Labyrinth construction, walnut veneered and cross-braced. Price £10.10.0 plus £1 deposit (returnable) for crate.

DEFERRED TERMS
ARE AVAILABLE
FOR ALL MODELS

Charles
AMPLIFIERS
LTD

1m, PALACE GATE, KENSINGTON, LONDON, W.8. 'PHONE : WES 3350.
Our units can also be seen at UNIVERSITY RECORDING CO., 16, Burleigh Place, Cambridge.
'Phone: Cambridge 54947.

FOR THE UTMOST REALISM FROM RECORDS AND RADIO

Measurement by Mullard

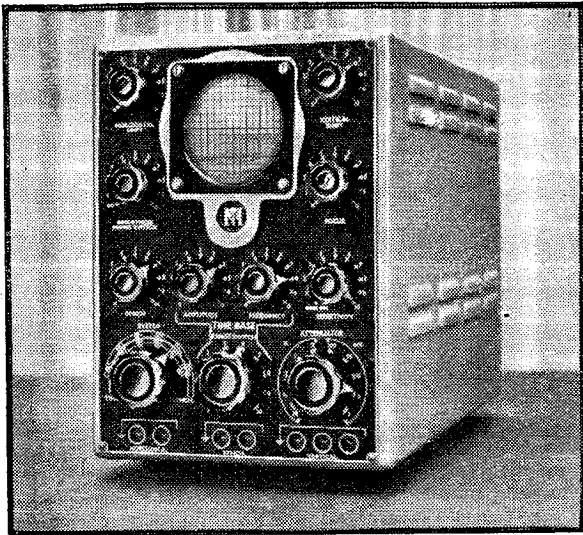

Mullard Oscillograph type E.800/1

The name of Mullard has for long been connected with cathode ray oscillographs, and their experience in this field is unequalled. Mullard cathode ray tubes, Mullard valves and Mullard circuitry have been combined to produce the accepted standard oscillograph.

Type E.800/1

Time base frequency 0.25—16,000 c/s.
Amplifier response (2 dB loss) 0.1—40,000 c/s.
Amplifier sensitivity (Max. Gain) 1 mV.rms/cm.
Delivery—Ex stock.

Type E.805

Time base frequency 5 c/s—150 Kc/s.
Amplifier response (3 dB loss) 2 c/s—2 Mc/s.
Amplifier sensitivity (Max. Gain) 5 mV. rms/cm.
Delivery—Ex stock.



Mullard

Electronic Products Ltd.

Electronic Equipment Division

ABOYNE WORKS, ABOYNE ROAD, LONDON, S.W.17.

(MI.276)

**Pushbutton?
Slider?
Rotary?
Band Selection?
Circuit Selection?
Tap Switching?**

Whatever it is—the answer is always OAK! Equalised pressure, double contact clips and floating rotors are exclusive features embodied in all special or standard type OAK switches

**WITHOUT QUESTION
SPECIFY**

OAK



SWITCHES

BRITISH N.S.F. CO. LTD., Keighley, Yorks.

Sole Licensees of OAK Manufacturing Co., Chicago

G6YA

G2BAR

**WESTERN GATEWAY HEADQUARTERS
for Radio and Television Components**

**The CABOT 25 Watt
HIGH QUALITY AMPLIFIER**

Incorporating negative feedback, suitable for any use where sound amplification is required.

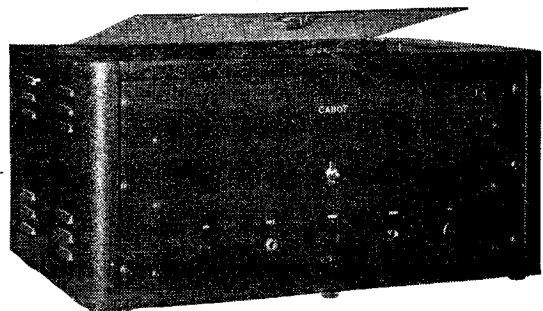

SPECIFICATION :—Separate mike and gram inputs for mixing. Mike input for moving coil or other types as required. Gram input suitable for standard Magnetic or Lightweight pick-up. Tone control. Output 25 Watts into 4-8 or 15 ohms. Input 110 230v 50 cps. Fitted in steel cabinet, finished in black crackle, panel engraved as illustrated. Ideal for general P.A. work, Youth Clubs, gram or radio Amplifier for the Home, etc. **VALVES** :—6SN7 Mike and Gram Mixer, 6SJ7 Amplifier, 6N7 Phase splitter, 6L6 Push Pull Power Amplifier, 5U4G Rectifier.

£16-10-0 Complete ready to play. Carriage paid Rail in England and Wales. Extra for passenger.

The Amplifier can be heard at our Bedminster Shop. Out-of-town Customers invited to Call at any time. Open Sats. 9—5.30 p.m.

CABOT RADIO CO., LTD.,

28, BEDMINSTER PARADE, BRISTOL, 3.

Tel.: 64314.

EDISWAN

SPECIAL PURPOSE VALVES

The DLS 10 is a vacuum delay switch designed on a new principle intended to overcome the disadvantages of the ordinary bi-metallic strip delay switch. The operating parts are enclosed in an evacuated glass bulb which renders the action immune from atmospheric influence.

It is particularly recommended for use with Mercury Vapour Rectifiers for providing the necessary delay before the anode voltage is applied and a typical application is shown here in a full-wave circuit, using two Half-Wave Mercury Vapour Rectifiers.

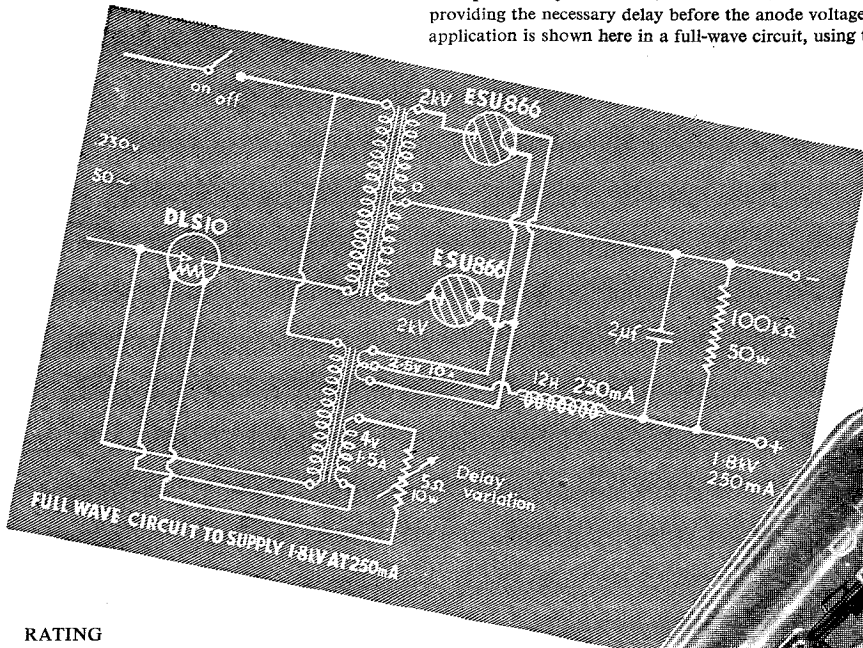

DLS. 10

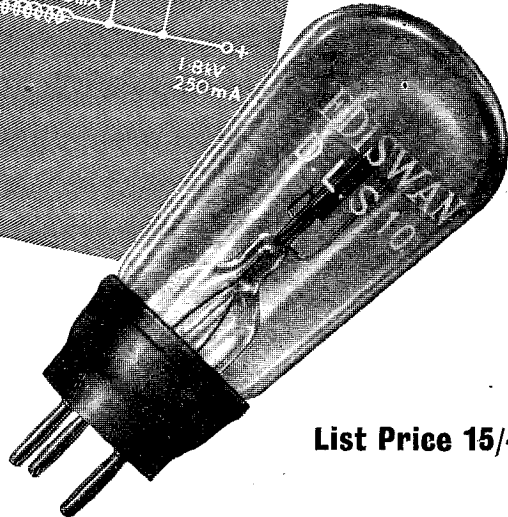

List Price 15/-

RATING

Filament Voltage (volts) .. V_f	4.0
Filament Current (amps) .. I_f	*1.5
Delay Time at 4.0v (secs) ..	Min 30; Max 90
Maximum Peak Current (low voltage rating) I_{pk}	6 amps at 250v
Maximum Peak Current (high voltage rating) I_{pk}	200 mA at 1kv

*at approximately 4.0v.

EDISWAN

THE EDISON SWAN ELECTRIC CO. LTD., 155 CHARING CROSS ROAD, LONDON, W.C.2



INTRODUCING THE R22/12
20-WATT, 12" P.M. LOUDSPEAKER
MORE POWER—STILL
GREATER EFFICIENCY—
 the ultimate development of the famous T2.
Available with two types of Cones:—
CONE TYPE "1205"
 Fundamental Resonance 75 c.p.s.
 (Designed for PUBLIC ADDRESS)
CONE TYPE "1206"
 Fundamental Resonance 55 c.p.s.
 (Designed for BASS REPRODUCTION)
 Write for descriptive leaflet D.69.



GOODMANS

R22

20-WATT 12" P.M.
17,500 GAUSS
Loudspeaker

FULLY DUSTPROOF

GOODMANS INDUSTRIES LTD. Lancelot Rd., Wembley, Middx.
 Telephone: WEMbley 1200 (8 lines). Telegrams: Goodaxiom, Wembley.

BULL'S RUISLIP DEPOT

Here is a list of high-grade goods which are available at very keen prices.
PLEASE NOTE.—That unless otherwise stated all goods are new and unused, and of recent manufacture and not Government Surplus.

ELECTROLYTIC CONDENSERS. (Only new stock from best manufacturers.)

2 mfd. 450 v.	1/2	8 mfd. 350 v.	1/6
4 mfd. 450 v.	1/3	16 mfd. 350 v.	1/11
8 mfd. 450 v.	1/11	32 mfd. 350 v.	1/11
16 mfd. 450 v.	2/8	25 x 25 mfd. 200 v.	3/11
8 x 8 mfd. 450 v.	3/4	8 mfd. 150 v.	1/3
8 x 16 mfd. 450 v.	3/4	25 mfd. 25 v.	1/-
16 x 16 mfd. 450 v.	3/9	25 mfd. 50 v.	1/6
16 x 8 x 24 mfd. 450 v.	4/9	50 mfd. 12 v.	10d.
		10 mfd. 25 v.	10d.

PHILLIPS wet electrolytics, standard type, can size 3in. high, 1 1/2in. dia., complete with locking screw for single hole fixing with bottom plate, 32 mfd. 320 v., 3/6; 14 mfd. 450 v., 2/9.

MIDGET TUNING CONDENSERS. 2 gang, 0.0035, fitted with trimmers, and complete with perspex dust cover. These condensers made by "PLESSEY," are of the type used for tuning personnel receivers. Price is 6/6, plus 8d. postage.

4-GANG TUNING CONDENSERS. .0005 each section—fitted trimmers—ceramic insulation. These are complete in a very useful chassis, and are fitted with a drive. Government Surplus equipment but new and perfect. Price 2/9, plus 1/3 postage. Case of six units, 17/6, carriage paid.

2-GANG .0005 CONDENSER. Standard size—ceramic insulation. Price 4/9, plus 9d. post.

CHOKES. IRON CORES L.F. (Surplus). 250 m.a. 10 henry, 9/6; 200 m.a., 6/-; 70 m.a., 4/6; 50 m.a., 3/9.

E.H.T. CONDENSERS (Surplus). .1 mfd. 5,000 v., 3/9; .02 mfd. 8,000 v., 3/9; .02 mfd. 5,000 v., 1/6.

PAPER CONDENSERS. We have all types in stock up to .1 mfd., 6d. each; .25 mfd., 8d.; .5 mfd., 11d. Parcel of 36 assorted, no more than two of any value, 12/6.

RESISTORS. Full range in stock, 1/4 and 1/2 watt, 4d. each, 1 watt, 5d. each. Parcel of 100 assorted, all useful sizes, no more than two of any one type, 12/6.

"ROLA" 5in. P.M. Speaker, fitted standard O.P. trans., 11/3.

"ROLA" 8in. P.M. Speaker fitted standard O.P. trans., 15/3.

"ROLA" 3in. P.M. Speaker, less output transformer, 8/9.

PLESSEY 10in. P.M., fitted standard output transformer, 29/6.

VOLUME CONTROLS—most values in stock—good makes—with S.P. switch, 4/6; less switch, 3/6.

TELEVISION TEST SET. Can you be sure that your E.H.T. voltage is up to scratch, that you are not over running your condensers or ruining your cathode ray tube? You can if you own a television test set. Absolutely essential for obtaining accurate information on E.H.T. supplies. Two ranges, 0-3,000 volts, 0-10,000 volts at 10,000 ohms per volt. A reliable instrument of modern design in a neat black crackle case, fitted with special high voltage terminals, connecting leads—non-fluoresher test prod, and polarity reversing switch, easily portable for service jobs. Sooner or later you will want one of these instruments—why not buy now at the special price of 85/- post paid?

ELECTRON HOUSE

WINDMILL HILL - RUISLIP MANOR - MIDDLESEX

BAKERS

'Selhurst'

RADIO

PIONEERS OF MOVING COIL SPEAKERS SINCE 1925

NEW 1949 MODELS
HIGH FIDELITY
SPEAKERS

The standard 12"
 P.A. model 12.C.

The World Famous
 12" triple cone 12.B.

The Cinema Model
 18" "Duplex" C.T.

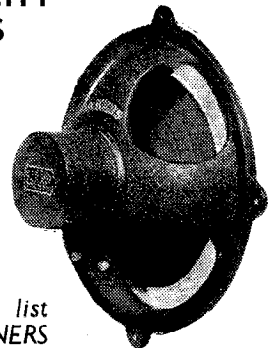

Write for illustrated list
 of —SPEAKERS, TUNERS
 and AMPLIFIERS.

BAKERS 'SELHURST' RADIO
 25, Dingwall Road, Croydon
 Telephone: CROYdon 2271/2

Cold Cathode Triodes

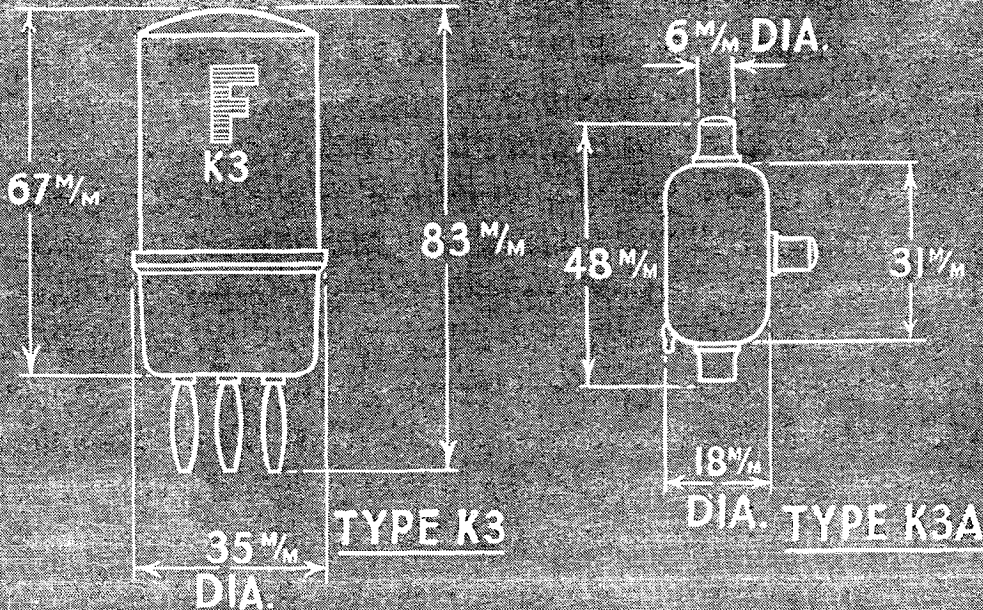

IMMEDIATE DELIVERY



Suitable for operation as relay tubes where the mean current does not exceed 5 milliamperes.

Operating Characteristics.	K3	K3A
Anode voltage	135	135
Trigger Breakdown voltage	79-84v.	85-95v.
Anode current (continuous)	5mA max.	5mA max.
Anode current (intermittent)	{ 20mA peak 5mA mean	{ 20mA peak 5mA mean
Trigger current	4/ μ A max.	4/ μ A max.
Recommended static bias	75 v.	75 v.
Gas filling	Neon	Argon

The K3 is supplied housed in a metal container, on an English 4 pin base. The K3A is supplied unmounted but with standard type valve caps for connecting purposes.

FERRANTI LTD

ELECTRONICS DEPT. MOSTON MANCHESTER 10

CONSISTENTLY *Accurate* PULLIN SERIES 100 TEST SET

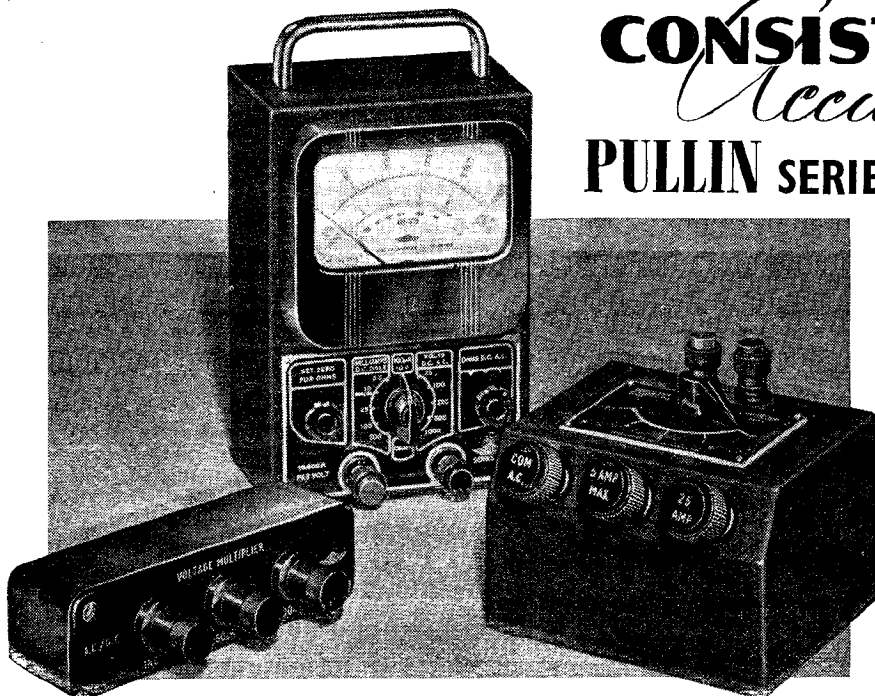

SENSITIVITY 10,000 OHMS/VOLT

with
A.C./D.C. Voltage Multiplier
for 2,500 V. and 5,000 V.

Volts A.C. and D.C. Range
10, 25, 100, 250, 500, 1,000.

Milliamps D.C. only:
2.5, 10, 25, 100, 500.

Ohms: 0-10,000 and 0-1 megohm.

A.C. Current Transformer
Range: 0.025, 0.01, 0.5, 1.0, 5.0,
25.0 Amps.



We can give early deliveries—
Address all enquiries to:

MEASURING INSTRUMENTS (PULLIN) LTD

DEPT. J. ELECTRON WORKS, WINCHESTER STREET, LONDON, W.3. Tel: ACOrr 4651/3 & 4995

EHT

2-6 KV Unit at
£3.15.0 retail
Complete.

RF EHT UNITS

SUITABLE FOR ALL

ELECTROSTATIC AND

ELECTROMAGNETIC

CATHODE RAY TUBES,

GEIGER COUNTERS,

INFRA RED IMAGE

CONVERTERS, Etc., Etc.

Units available to 25 KV.

Trade supplied.

HAZLEHURST DESIGNS LTD.,

186, BROMPTON ROAD, KNIGHTSBRIDGE,
LONDON, S.W.3

KENSington 7793

BRIERLEY PICKUPS

Ribbon type JB/P/R/2

Microarmature type JB/P/A/1

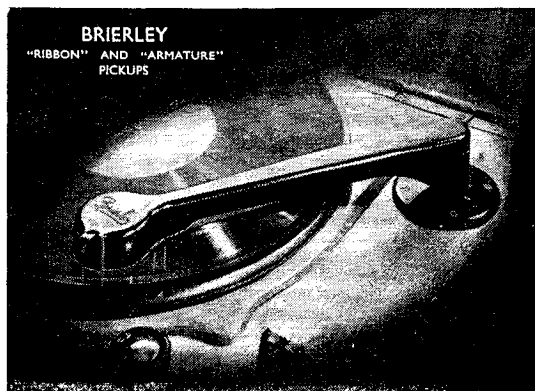

BRIERLEY
"RIBBON" AND "ARMATURE"
PICKUPS

New illustrated "literature" should be available by the time this announcement appears, giving full information on the latest developments.

Write for your copy:

J. H. BRIERLEY (GRAMOPHONES & RECORDINGS) LTD.,
46, TITHEBARN STREET, LIVERPOOL.

PREMIER RADIO COMPANY

MORRIS & CO. (RADIO) LTD.

207, EDGWARE RD., W.2 Phone: AMBassador 4033

AND AT 152-153, FLEET STREET, E.C.4 Phone: CENTral 7833

All POST ORDERS to 167, LOWER CLAPTON ROAD, LONDON, E.5. 'Phone: AMHerst 4723.

Terms of Business: Cash with order or C.O.D. over £1. Send 2d. Stamp for list.

EDGWARE ROAD IS OPEN UNTIL 6 p.m. ON SATURDAYS

ALL-WAVE TUNING PACK FOR DETECTOR AND L.F. RECEIVER. Tunes from 12-2,000 metres without gaps. The unit ready wired and tested. The circuit diagram of our 2-valve all-wave set is supplied with each pack. Price 25/- inc. P.T.

PREMIER 4-BAND COIL PACK. Consists of a fully-wired and calibrated Coil Pack of the latest type. 5 Position Switch includes a gram. position. Wavebands covered: 13.6-52 metres (22-3.3 Mc/s.), 91-200 metres (5.9-1.5 Mc/s.), 200-550 metres and 900-2,100 metres. Air Dielectric Trimmers on all Shortwave Coils. Unit consists of 3 Screened Sections, Aerial, R.F. and Oscillator Dimensions of Pack, 6in. x 4 1/2in. x 2 1/2in. Price, with circuit diagram, £4/11/8 (including P.T.).

SETS OF PREMIER COILS. These are the Coils used in Premier Midget Kits. A pair of TRF Coils comprising Aerial Coil and H.F. Transformer covering 200-557 and 900-2,000 metres. 6/- per pair. Set of 4 Coils for a Superhet Receiver. 2 Oscillator and 2 Aerial Coils covering 16-50 and 200-550 metres 10/6 set.

LOUDSPEAKERS, by famous makers. Brand new in Makers cartons. 6in., 10", 6 1/2in., 16.6; 8in., 17.6; 10in., 23.6. 10in. variants £2/11 each extra.

2-GANG CONDENSERS. 0005 mF. ceramic insulation, 4/9 each.

CARBON POTENTIOMETERS. All values from 5 K to 2 meg. Long Spindles, 2/9 each. With switch, 4/6.

HAND MICROPHONES. With Carbon insert. Switch in handle, 2/11.

WESTINGHOUSE J50 E.H.T. RECTIFIERS. Output 490 volts 2 mA. Any number can be used in series. Price, 3/6 each; 6 for 18/-.

PREMIER EXTENSION SPEAKERS. A 5in. P.M. Speaker in an attractive Bakelite case coloured cream or walnut, 6 1/2in. x 6 1/2in. x 3 1/2in. With volume control, 30/-.

HEADPHONES. Sensitive low resistance double headphones with balanced armature units. Price, 3/6 per pair.

HIGH GRADE P.M. MOVING COIL MICROPHONES by a famous maker. Price, £5/5/-.

MULLARD MW 18-2 Magnetic Tubes, 7in. 2 v., 5 kV. max. H.T., 79/6.

MASKS FOR VCR97 tubes, 3/6 each.

C.R. TUBES. VCR97, 6in. diameter, green screen, 4 v. 1 a. Heater, 2,500 v. max. H.T. Complete with socket, in maker's original cartons, 35/-.

C.R. TUBES. E.M.L.4/1 Cathode Ray Tubes, 3 1/2in. diameter, green screen, short persistence, 4 v. 1-3 a Heater, 800 v. H.T. Complete with socket, 17/6 each.

COLLARO AUTO CHANGERS. Mixer-changer rim-drive. High fidelity, crystal pick-up. Repeat reject mechanism, £14/6/8.

COLLARO A.C./D.C. GRAMOPHONE MOTORS, with turntable, but without pick-up or auto stop, £3 5/6.

COLLARO ELECTRIC GRAMOPHONE MOTOR with 12in. turntable. A.C. 100/250 v., £5/18/4.

CONRAD ELECTRIC GRAMOPHONE MOTOR, 9in. turntable, 200/250 v. A.C., 57/6.

All above motors include purchase tax.

TELEVISION MAGNIFYING LENS. Suit any 5in., 6in., or 7in. tube. Increase picture size considerably, 29/6.

P.P. DRIVER TRANS. Split Sec., super quality, 10/-.

METERS				
Full Scale Deflection	Scale Marking	External Dimensions	Movement	Price
1 mA	0-100	3 1/2in.	M/C	15/11
1 mA	0-1	2 1/2in. x 2 1/2in.	M/C	7/6
5 mA	0-5	2 1/2in.	M/C	5/-
30 mA	0-30	3 1/2in.	M/C	10/6
50 mA	0-50	2 1/2in. x 2 1/2in.	M/C	8/6
150 mA	0-150	3 1/2in.	M/C	6/-
250 mA	0-250	3 1/2in.	M/C	10/-
2.5 amp.	0-2.5	2 1/2in.	Thermio.	5/-
20 v.	0-20	2 1/2in. x 2 1/2in.	M/C	5/9
40 v.	0-40	2 1/2in. x 2 1/2in.	M/C	5/9
5000 v.	0-5	4 1/2in.	Elect.	50/-
500 u.a.	0-500	2 1/2in.	M/C	7/6

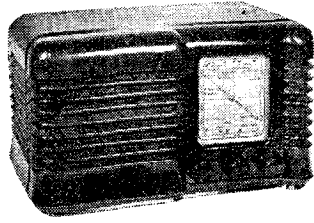

NEW PRICES

PREMIER MIDGET RADIO RECEIVER. Due to greatly increased production we are now able to offer this receiver at a greatly reduced price. The Receiver is housed in an attractive Bakelite case, 12in. long x 5in. wide x 4in. high. The valve line-up is 6K7, 6V6, 6V5 and a Selenium Rectifier in the A.C. model; and 6K7, 6J7, 25A6 and Selenium Rectifier in the A.C./D.C. model. Both are for use on 200 to 250 volt mains. The dial is illuminated, and the receiver presents a very attractive appearance. Coverage is for the medium and long wavebands. PRICE £6/15/-.

Complete kit of parts with diagrams, £6/6/-, inc. Purchase Tax.

PREMIER MIDGET SUPERHET RECEIVER. This powerful Midget Superhet Receiver is designed to cover the short-wave bands between 16 and 55 metres and the medium wavebands between 200 and 557 metres. Two models are produced, one for 200-250 volt A.C. mains; and the other for 200-250 volts A.C. or D.C. mains and both are supplied in the same plastic cabinet, as the TRF Receiver. The A.C. valve line-up is 6K8, 6K7, 6Q7, 6V6 and a selenium rectifier. The A.C./D.C. line-up is the same, with the exception of the output valve which is a 25A6. The dial is illuminated, making a very attractive receiver. PRICE: £8/19/6.

Complete kit of parts with diagrams, £8/8/-, inc. Purchase Tax.

PLASTIC CABINETS, as illustrated above:—In Brown, 17/6. In Ivory, 22/6.

L.F. CHOKES. 50 mA., 40 H., 10/6; 100 mA., 6 H., 5/-; 125 mA., 13 H., 10/6; 200 mA., 20 H., 17/6; 500 mA., 20 H., 25/-.

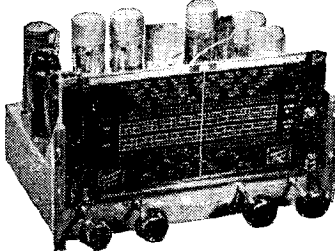

A NEW A.C. ALL-WAVE SUPERHET RECEIVER. 7 Valves (plus metal Rectifiers) for 200/250 volts; 40/60 cycle A.C. mains. 4 wavebands, 13.6-52, 51-200, 200-550 and 900-2,100 metres. Pick-up input. Uses 6K7, 6K8, 6K7, 6B8, 6J7 and 2-6V6 in push-pull, giving an output of 10 watts. Specially designed OP Transformer to match 6V6's 4, 8 and 15 Ohm Speakers. Negative feedback is applied over 3 stages giving a high fidelity output. Completely wired and tested: £15/17/9. Our Universal model is still available at £15 built; or £13/8/- in kit form. All prices include Purchase Tax.

ALUMINIUM CHASSIS, 16 S.W.G. Substantially made of bright Aluminium with four sides. 7in. x 3 1/2in. x 2 1/2in., 9/3; 9 1/4in. x 4 1/2in. x 2 1/2in., 4/-; 10 1/4in. x 5in. x 2 1/2in., 5/6; 12in. x 9in. x 2 1/2in., 6/8; 14in. x 8in. x 2 1/2in., 6/11; 16in. x 8in. x 2 1/2in., 7/3; 20in. x 8in. x 2 1/2in., 7/11; 22in. x 10in. x 2 1/2in., 10/-; 10in. x 9in. x 3in., 6/8; 12in. x 10in. x 3in., 6/10; 14in. x 10in. x 3in., 7/11; 16in. x 10in. x 3in., 8/6; 20in. x 10in. x 3in., 10/-.

E.H.T. TRANSFORMERS. For 200-250 v. 50 c. input half wave. For use with valve or metal rectifier. Used in a voltage doubling circuit, these will give slightly over double the half-wave output. We can supply suitable rectifiers.

E.H.T.1. Output 800 v. 17/6
 E.H.T.2. Output 1,000 v. and 2-6-9 v. 2 a. 25/-
 E.H.T.3. Output 2,000 v. and 2-0-2 v. 2 a. 35/-

HAZELTINE E.H.T. units 5.5 kV., complete, 75/-.

9-WAY PUSH BUTTON UNITS, without knobs, 3/6.

METAL RECTIFIERS

230 v. 30 mA.	2/6
260 v. 30 mA.	3/-
300 v. 75 mA.	4/-

H.T. ELIMINATOR AND TRICKLE CHARGER KIT. Consists of a complete kit of parts to construct an H.T. Eliminator with an output of 120 v. at 20 mA., and provision for trickle charging a 2 v. accumulator. Two metal rectifiers are employed. With circuit, 35/-.

MINE DETECTOR PANELS, include three 174 valves, 12-1 Midget Trans., three ceramic valveholders, 18 condensers and resistors, etc., 20/-.

Without valves, 5/-

WIRE WOUND RESISTORS, 50 K. 200 watt, 4/-; 20 K. 200 watt, 4/-; 2K + 12 K 150 watt, 4/-; 75 K. 100 watt, 4/-; 350 Ohm 75 watt, 2/-.

PREMIER MAINS TRANSFORMERS. All primaries are tapped for 200-230-250 v. mains, 40-100 cycles. All primaries are screened. All L.T.s are centre-tapped.

List No.	Output	Price
SP.175A.	175-0-175 v. 50 mA., 6.3 v. 2-3 a., 5 v. 2 a.	25/-
SP.175B.	175-0-175 v. 50 mA., 4 v. 1 a., 4 v. 2-3 a.	25/-
SP.250A.	250-0-250 v. 60 mA., 6.3 v. 2-3 a., 5 v. 2 a.	25/-
SP.250B.	250-0-250 v. 60 mA., 4 v. 1-2 a., 4 v. 3-5 a.	25/-
SP.300A.	300-0-300 v. 60 mA., 6.3 v. 2-3 a., 5 v. 2 a.	25/-
SP.300B.	300-0-300 v. 60 mA., 4 v. 2-3 a., 4 v. 3-5 a., 4 v. 1-2 a.	25/-
SP.301A.	300-0-300 v. 120 mA., 5 v. 2-3 a., 6.3 v. 3-4 a.	28/-
SP.301B.	300-0-300 v. 120 mA., 4 v. 2-3 a., 4 v. 2-3 a., 4 v. 3-5 a.	28/-
SP.350A.	350-0-350 v. 100 mA., 5 v. 2-3 a., 6.3 v. 2-3 a.	29/-
SP.350B.	350-0-350 v. 100 mA., 4 v. 2-3 a., 4 v. 2-3 a., 4 v. 3-5 a.	29/-
SP.352.	350-0-350 v. 150 mA., 5 v. 2-3 a., 6.3 v. 2-3 a., 6.3 v. 2-3 a.	36/-
SP.501A.	500-0-500 v. 150 mA., 5 v. 2-3 a., 6.3 v. 2-3 a., 6.3 v. 2-3 a.	50/-

THE NEW PREMIER TABLEGRAM A modern Tablegram, incorporating many new features. Covers Medium and Long wavebands. Operates on 200-250 v. A.C. Mains. A high-fidelity pick-up and the latest Collaro electric gram. motor ensure excellent record reproduction, £19/19/-, including Purchase Tax.

R107. ONE OF THE ARMY'S FINEST COMMUNICATIONS RECEIVERS. (See 'W.W.', August, 1945), 9 valves, R.F. amp. osc. Frequency Changer, 2 L.F.s (465 kc.), 2nd Detector, AVC. Af. amp. B.F.O. A.C. mains, 100-250 v. or 12 v. accum. Frequency range 17.5 to 7 Mc/s, 7.25 Mc/s to 2.9 Mc/s, 3.0 to 1.2 Mc/s Monitor L S built in. Complete. Write for full details £16/16/-.

METER KIT
A FERRANTI 500 MICROAMP M/C METER, with separate High Stability, High Accuracy, Resistors to measure 15, 60, 150 and 600 volts D.C. Scale length 1 1/2in., diameter 2 1/2in. 10/- the complete kit.

WESTINGHOUSE BATTERY CHARGERS, input 200-250 volts 50 cycles, output 12 volts 16 amps, with meter and variable resistance. 10 gs.

SECTIONAL WHIP AERIAL. Seven sections which plug into each other making an aerial 14ft. long. Thinest section 1in. diam., thickest section 1 1/2in. diam. Weather proof enamel. 3/6 each complete.

INSULATED BASE for above 2/6 each.

NEW LIST NOW READY

WRITE FOR DETAILS OF OUR NEW TELEVISION SET THE PRICE IS ATTRACTIVE

KNOBBS DIALS & POINTERS *by* **PAINTON**
of **NORTHAMPTON**

PAINTON & CO LTD · KINGSTHORPE · NORTHAMPTON
Telephone: Northampton 2820 *Telegrams: Ceil Northampton*



Inductance Meter

TYPE MI48-2

This instrument has been designed to provide simple and direct reading measurement of inductance values between 0.05 microhenry and 100 millihenrys. A stable variable-frequency oscillator is

used to resonate the unknown inductance with a fixed standard capacitor. Provision is made for the measurement of Q at resonance frequency. **Price £38.50.**

Wayne Kerr

WAYNE KERR LABORATORIES LIMITED, NEW MALDEN, SURREY.

WIRING IS EASIER AND QUICKER WITH A "PYROBIT" IRON

To the amateur assembler, the "ham," the serviceman and the manufacturer, the Special Radio "PYROBIT" Electric Soldering Iron is the first essential tool. Light weight, perfect balance and handy shape double the pleasure and speed of wiring.

See one at your Radio, Electric or Hardware Shop or write for full details.

SPECIAL RADIO MODEL
7oz. 45watts
22/-

THE ACRU ELECTRIC TOOL MFG. CO. LTD.

123 HYDE ROAD, MANCHESTER 12. Tel: ARD. 4284

P.4

THE SIGNAL RECTIFIER

Before going on to deal with the last major link in the reproduction chain — that of the output stage and loudspeaker, there is one part of the receiver which merits a little closer attention than we have so far given it. We have discussed briefly the radio or carrier side of the amplifier and also the audio frequency amplifier stages. There is an all important link between them, the signal rectifier and often associated with it, the A.V.C. rectifier. It is probably true to say that it is easier to allow harmonic distortion to creep in at this point than at any other part of the complete set. Further, because one is essentially dealing with a rectifier which is a non-linear element, the application of theory to practical cases is far more difficult than it is where the circuit elements are at least intended to be linear.

* Perfect Reproduction?

* PROBLEMS REFERRED TO IN PREVIOUS NOTES

Spatial Distribution of Sound.
Echoes in the Listening Room.
Limitations of Single Channel.
Limitations of the Human Ear.
Distortions and Faults caused by
Apparatus.
The Radio Link.
Frequency Response.
Non-linearity.

Signal rectifiers of various sorts have been used and proposed since the beginning of radio but the plain diode rectifier is now almost universally used. It combines the excellence of the leaky grid detector for small inputs with a virtually unlimited signal handling capacity; in fact, the larger the input the more likely it is that the audio output will follow the modulation envelope.

It is far beyond the scope of these few notes to go into the detail of detector design at all fully. All we can hope to do is to mention the points upon which care is needed and leave the elucidation of just how to tackle the problems that arise for future study in suitable textbooks.

Let us look first of all, therefore, at causes of distortion in a diode rectifying circuit consisting of the usual tuned circuit input with a resistive diode load shunted by a by-pass condenser. The function of this condenser is two-fold. Firstly, to prevent as far as possible the passing on to further stages of the unwanted carrier frequency. Secondly, to increase the audio output of the diode by making it a peak, and not a mean, reading device.

This condenser, however, is the first point at which distortion arises. In fact, any integrating condenser must induce some distortion for the following reason:—

Consider the rectification process during a period when the amplitude of the carrier is increasing; *i.e.*, during the positive slope of the modulation envelope. The diode will charge the integrating condenser up to the peak input value at each positive carrier peak and this charge will leak away during the gap before the next cycle. The voltage across the condenser therefore will resemble a series of steps, the rising part of which is nearly vertical while the falling portion will be more or less steep, depending on the time constant of the diode load and condenser.

Now consider the same process when the carrier amplitude is decreasing; *i.e.*, during the negative slope of the modulation envelope. The same argument as was used above shows immediately that the shape of the audio output we have must be differ-

ent. In fact, if the time constant of the diode load and condenser is made too large, the rate of decay during one cycle of carrier frequency may not be sufficient for the voltage to have fallen by as much as the modulation envelope has fallen in the same time.

When this happens, the diode is said to have failed to "track" and quite severe distortion must result. This is very well known but it is not always realised that even though tracking is achieved, some small distortion must nevertheless still remain.

It is easy to see that the distortion is smallest when the ratio of the modulation frequency to the carrier frequency, and the percentage modulation, are both small. In other words, that distortion is unlikely to be serious for low audio frequencies or for low percentage modulations. As a rough guide, one can say that R/C must be small compared with pM (Where R and C are the resistance and capacitance of the diode load; p is the modulation pulsation and M the percentage modulation.)

In transferring the audio component from the diode load to the first low-frequency amplifier, it is usual to interpose a blocking condenser so that the bias conditions of the audio valve are not affected by the carrier level at the diode. It immediately follows, therefore, that the load on the diode for A.C. conditions is different from that at D.C. conditions since the grid leak of the audio valve is in parallel with the actual diode load at audio frequencies. The ratio of this A.C. diode load to the D.C. value must be kept as high as possible since as soon as the modulation depth exceeds this ratio (expressed as a percentage), distortion sets in.

A little consideration will show that it is impossible to avoid distortion for, say 90% modulation without losing gain either at carrier frequency or audio frequency. We cannot ask the first audio valve to have a grid leak greater than about 1 megohm so that to obtain distortionless rectification for 90% modulation, the diode load cannot exceed 100,000 ohms. For normal intermediate frequency circuits this is rather a low value and can only be achieved satisfactorily by losing gain in the last intermediate frequency transformer. An alternative method of course is to tap the feed to the audio valve down the diode load, losing in this case audio frequency gain.

***murphy radio
limited***

...the Paragon of Instrument Virtues

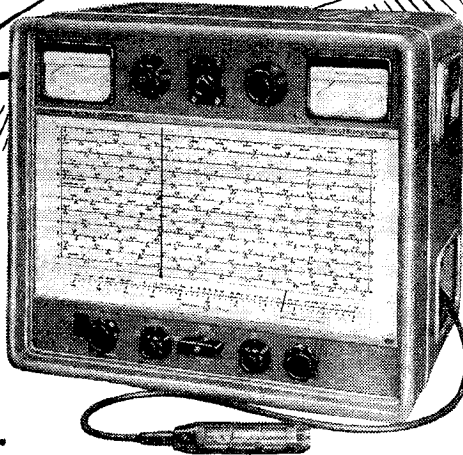

Type TF867 excels even the best of previous Marconi SIGNAL GENERATORS. Its virtues are impressive both mechanically and electrically, for design and performance are alike superlative.

The expanding wide view scale is a unique innovation. So, too, is the concentric terminating unit which serves as dummy aerial, provides source impedances of 75Ω and 13Ω and shows diagrammatically the exact conditions of circuit. Prominent among other features are freedom from unwanted frequency modulation, crystal standardisation, deep-amplitude or carrier shift modulation and stabilised output level. Over the range 15 Kc/s to 30 Mc/s, output is continuously variable from 0.4 μV to 4V; calibration indicates true artificial signal e.m.f. irrespective of load. Full technical information is freely available.

SIGNAL GENERATOR

Type TF 867

MARCONI INSTRUMENTS LIMITED

ST. ALBANS, HERTFORDSHIRE • Telephone: St. Albans 6161/5

Northern Office: 30 Albion Street, Hull • Western Office: 10 Portview Road, Avonmouth • Southern Office and Showrooms: 109 Eaton Square, London, S.W.1 • Midland Office: 19 The Parade, Leamington Spa

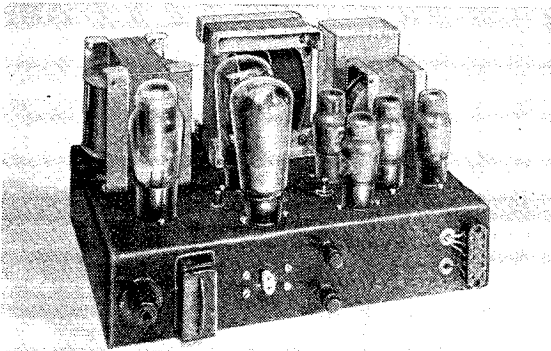

HI-FIDELITY AMPLIFIERS

AS DESCRIBED BY D. T. N. WILLIAMSON IN W.W. MAY 1947

AS ILLUSTRATED	£19 19 0
COMPLETE RANGE USING P.X.4's, K.T.66's, AVAILABLE FROM	£19 19 0
P.X.25 AMPLIFIER WITH TWO SEPARATE H.T. SUPPLIES	£30 10 0
<i>(See April advert.)</i>	
TONE CONTROL GIVING SEPARATE CONTROL OF BASS AND TREBLE WITH K.T.Z.63	£7 10 0
WITH E.F.37's FOR HIGH GAIN	£8 0 0
PARTRIDGE TRANSFORMERS AND B.V.A. VALVES AS STANDARD	

Illustrated Brochure now available

Manufactured by

GOODSELL LTD., 40 GARDNER ST., BRIGHTON

TELEPHONE: BRIGHTON 6735

Easy Terms from

LONDON RADIO SUPPLY CO., BALCOMBE, SUSSEX

Speaking
of
Operations



Speaking of operations, a delicate but highly successful one has been carried out in striking the balance of correctly matched voice coil and curvilinear cone for our new 12" loud speaker. By carefully

suiting the weight of coil to cone we have reduced the peaks and secured a freedom from break-up, while the very high flux density of the large Alcomax magnet considerably increases the sensitivity, especially in the higher frequencies. All very worth while as you may see, or rather hear.

GRAMPIAN 12" SPEAKER TYPE 3512/15

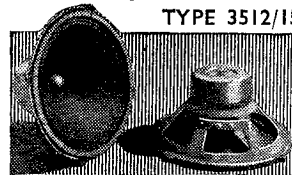

Overall diam. 12 3/4". Depth 6". Weight 7lb. 15 ozs. Voice Coil Impedance 15 ohms. Fundamental resonance 60 cycles. Flux density 14,000 lines per. sq. cm. Frequency range 50-7,000 c.p.s. Fixing holes 4 holes 3/4" diam. spaced 90° on P.C.D. 12 3/4".

DELIVERY FROM STOCK
LIST PRICE £6-10-0

GRAMPIAN REPRODUCERS LTD
Hampton Road, Hanworth, Middx. Phone: Felcham 2657



A good thing in a small package

OSRAM MINIATURE VALVE

TYPE Z77 HIGH-GAIN PENTODE

It is a high-gain pentode, mounted on the B7G base and is suitable for use in television, wide-band radio, amplifier and electronic instrument circuits.

INTERESTING FEATURES

Small size and rugged construction make it an eminently suitable valve for use in mobile and portable equipment. Suitable for operation up to 100 megacycles per second. Owing to smallness of size and low thermal capacity the valve rapidly reaches a stable operating condition.

List Price 17/6. Purchase Tax extra.



Osram
PHOTO CELLS

S.E.C.
CATHODE RAY TUBES

Osram
VALVES

THE GENERAL ELECTRIC CO., LTD., MAGNET HOUSE, KINGSWAY, W.C.2.

University Radio, Limited

OFFER GUARANTEED USED EQUIPMENT AT ATTRACTIVE PRICES

Gray (U.S.A.) 20-30 watt Amplifiers, 6L6's p-p. Gram and Mike input. Ex-W.D. With valves. As new.....	£10 10 0	Taylor Signal Generator, Model 65B. As new.....	£12 0 0	Another E.D.C.C. Rotary Converter, 200 watt.....	£12 10 0
8 watt Amplifiers. Ex-W.D. 6V6's P-P. Mike input with valves.....	£7 7 0	Taylor Valve Tester. Latest type. As new.....	£12 10 0	Ditto, 250 watt.....	£20 0 0
Avo Model 7's. As new.....	£13 10 0	Taylor Portable Valve-tester and Test-meter, combined. Mod. 47 A.P. As new.....	£20 0 0	Moving-coil Mikes, well-known makes from.....	£2 10 0
Avo Model 7's with leather case. As new.....	£15 10 0	Taylor Valve-tester. Latest mod. As new, 500v.....	£12 0 0	Vitavox K12-10. As new.....	£4 10 0
Avo Model 40. As new.....	£11 0 0	Avo Valve-tester, in good cond. and working order.....	£9 0 0	Goodman's 12in. P.M. As new.....	£4 10 0
BC.348, converted for A.C. mains. With valves. In very good condition.....	£12 10 0	Evershed Vignoll's Wee Megger. As new.....	£7 10 0	Goodman's Axiom 12in. P.M. As new.....	£5 10 0
Collaro Micro-gram, complete with valves. As new.....	£14 10 0	Evershed Vignoll's Wee Megger, in perfect cond. and working-order. 500v.....	£6 0 0	Goodman's Cabinets, for 12in. P.M.s. As new.....	£3 0 0
Baker 16in. P.M. Latest model. As new.....	£5 17 6	Evershed Vignoll's Bridge-Megger. As new.....	£20 0 0	Garrard Record-Player Unit. As new. In cabinet.....	£8 0 0
Collaro AC/DC Gram-unit. Latest model as new.....	£9 0 0	Record Wee Megger, with leather case. As new.....	£8 0 0	Trix Auto-Changer, mixer-type, portable record-player with built-in amplifier and speaker. As new.....	£26 0 0
Furzehill BFO Unit. As new.....	£22 10 0	Romac 25-watt Amplifier, complete with Record-player. As new.....	£22 10 0	FOUR ONLY. Portogram (brand new) 15-watt A.C.-D.C. portable amplifiers, built-in speaker. Mike and gram. input. Beautiful job at a bargain price.....	£16 0 0
Taylor 20,000 (O.P.V.). A.C. D.C. Test Meter. Mod. 83C. Good cond. and working-order.....	£10 10 0	Romac 25-watt Amplifiers, with built-in radio. As new.....	£17 0 0	Garrard Auto-changer, A.C. type, R.C.I. Exceptionally good condition.....	£10 0 0
Auto Record-changer, in portable case. Crystal Pick-up. As new.....	£12 17 6	B.S.R. Ampligram, Mod. AG4. As new.....	£28 10 0	Rothermel Ball-type Sound Cell Crystal Mikes. As new.....	£5 0 0
Avo Valve-tester with roller-panel. As new.....	£11 0 0	Senior Crystal Pick-ups, with volume-control. Brand new.....	£1 19 6	Avo Minor D.C. As new.....	£2 12 0
Marconi Personal Portable Radio. With valves and batteries. Complete.....	£10 0 0	Douglas Wave-coil Winder. Perfect condition.....	£14 0 0	M.S.S. Disc Recording Unit, with Play-back pick-up. Less amplifier. As new.....	£40 0 0
Herme's Portable Book-radio. Complete with valves and batteries. As new.....	£8 0 0	Hunt's All-wave Signal-Generator. Perfect condition and working-order.....	£7 10 0	Taylor Capacity and Resistance-bridge. As new. Latest model.....	£8 10 0
Garrard Auto-change Unit. Latest model. Mixer-type. Not rim-drive. Brand new, in makers' carton.....	£18 0 0	E.D.C.C. Rotary Converter, in metal silencing-case, with radio filter-unit. DC250v.—AC230v., 50 cycles, 120 watt. Perfect cond. and working order.....	£10 10 0	Hunt's Capacity and Resistance Bridge. As new.....	£11 10 0
				Hunt's Capacity and Resistance Bridge, pre-war model. In very good condition.....	£6 10 0
				Taylor A.C./D.C. Minor. As new.....	£5 0 0

Hundreds of other items too numerous to list at Bargain Prices. Please state requirements. No lists and no C.O.D., cash or cheque with order. All items listed are CARRIAGE PAID.

22 LISLE STREET, LEICESTER SQUARE, LONDON, W.C.2

Phone GERrard 4447 & 8582. Hours 9 to 6. Thursdays 9 to 1.

A NEW B.P.L. INSTRUMENT



THE VOLTASCOPE—A combined valve-voltmeter and oscilloscope. **VALVE-VOLTMETER**—Infinite Input Resistance for D.C. ranges 0 to 300 volts. A.C. ranges 0 to 180 volts in 5 ranges. 3½ inch scale meter. **OSCILLOSCOPE**—3 inch screen tube provided with balanced amplifiers for Y and X plates giving a 5 times trace expansion. Maximum sensitivity 150mV/cm. Response from D.C. to 100 kcs.

Limited quantity available for early delivery.

BRITISH PHYSICAL LABORATORIES
HOUSEBOAT WORKS, RADLETT, HERTS.

Tel: Radlett 5674-5-6

THE RIMINGTON JEWEL

will bring new life to

GRAMOPHONE REPRODUCTION



Straight for Crystal pick-up only.



Lightweight for new miniature pick-up.



Trailer type for Heavier pick-up.

- ★ Reproduces the maximum recorded frequency range.
- ★ Wear on records is negligible, the jewel is scientifically designed to follow the groove of the record lightly and smoothly.
- ★ Preserves the higher frequencies delicately imprinted in the record, so easily destroyed, and reproduces them!
- ★ Jewel well set and angle correct.
- ★ Contained in plastic box well packed and mounted.
- ★ LIFE. It is not possible to state categorically the life of a jewel point, but in the interest of quality it is advisable to replace the jewel after 1000 playings—it is a matter of personal discretion.
- ★ The Rimington Jewel has had exhaustive tests by Messrs. W. R. Prior Ltd., microscope manufacturers, of Bishops Stortford, who have stated that the needles are free from blemish and perfect in detail.
- ★ The Rimington Jewel needle reveals new beauties in your records which you have heretofore unsuspected.

PRICE—Most reasonable. The Rimington Jewel is the finest sapphire on the market and it retails at only 9/9.

Order your Rimington Jewel NOW and revolutionise your gramophone reproduction.

TRADE ENQUIRIES INVITED

RIMINGTONS

RIMINGTON, VAN WYCK LTD., 42-43 Cranbourn St., London, W.C.2
Gerrard 1171
RIMINGTON, VAN WYCK (Mail Order) LTD., 28a Devonshire St.,
Marylebone, London, W.1 Welbeck 4695

They speak for themselves . . .

*fidelity of response
speaks for itself to the
discriminating ear.*

*Precision manufacture is
no less eloquent to the
trained engineer. These*

qualities make

TRUVOX speakers famous

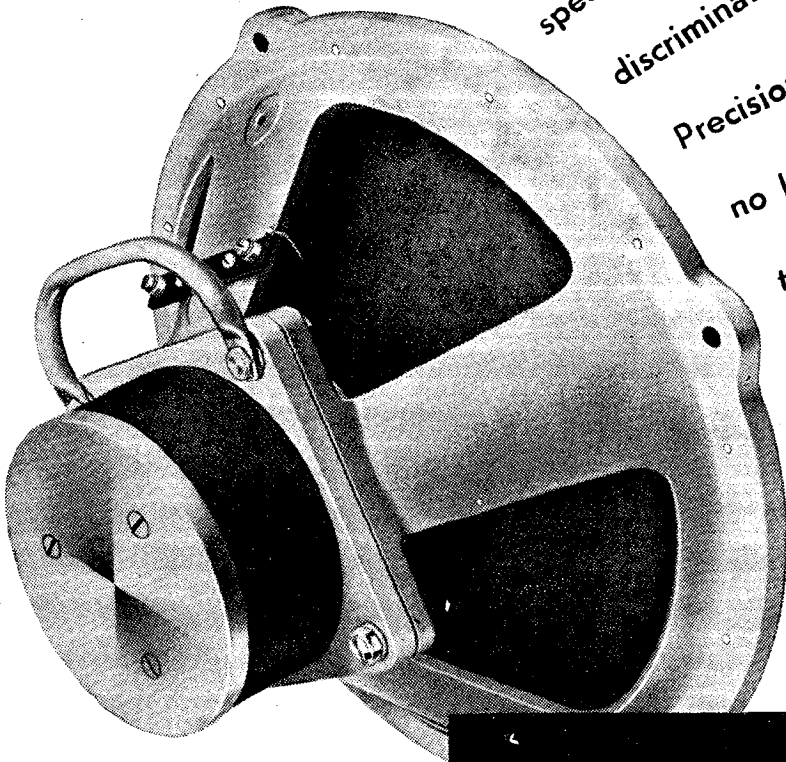

The SS10A 12-inch Heavy Duty Speaker, illustrated, offering a frequency response from 55 to 11,000 c.p.s. and handling 10 watts is a typical example of TRUVOX workmanship.

TRUVOX

TRUVOX ENGINEERING CO. LTD · EXHIBITION GDS · WEMBLEY · ENGLAND

Research Routine testing Production

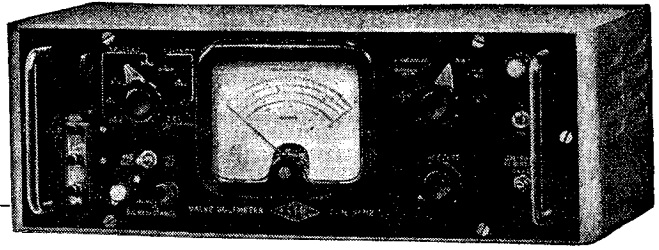

serve all three sections of Industry

THE VALVE VOLTMETER shown possesses a high degree of accuracy and covers a wide frequency range. It is designed for both bench use and for forward-mounting on a standard 19 in. rack. A low-loss probe for use at high frequencies is provided. Balanced, unbalanced and differential A.C. voltages may be measured, and the circuit is arranged to measure positive and negative D.C. voltages. The instrument is free from drift and zero setting is constant on all ranges.



SPECIFICATION

A.C. RANGE: 0-1.5 V, 0-5 V, 0-15 V, 0-50 V, 0-150 V, Balanced, Unbalanced and Differential.
D.C. RANGE: 0-5 V, 0-50 V, 0-500 V.

RESISTANCE RANGE: 0-1,000, 0-10,000, 0-100,000 ohms. 0-1, 0-10, 0-100 megohms.
FREQUENCY RANGE: 30 c/s to 10 Mc/s with probe mounted. 10 kc/s to 200 Mc/s with probe unmounted.

ELECTRONIC INSTRUMENTS and INDUSTRIAL EQUIPMENT

AIRMEC LABORATORIES LTD., High Wycombe, Buckinghamshire, England. Tel: High Wycombe 2060. Cables: Commlabs

Jag STRIPS

40 each of three types shown
120 for 5/-
Post 6d.

Rotary SWITCH PARTS

4 each switch wafers - 3pole 3way, 2pole 4way 1pole 6way; 3 spare 6" locators, nuts & bolts. All for 5/- + 6d post.

MINIATURE JONES PLUGS & SOCKETS

USA make 3 PAIRS 8 contact size 1 1/2" x 1/4" for 5/-
Post 6d.

Shock proof MOUNTINGS

4 of each of three sizes 1 1/2" - 1 3/4" - 2 1/4" square 12 for 5/-
Post 6d.

Ceramic STAND-OFF INSULATORS

5/8" high. Less terminal bolt 24 for 5/-
A 7/8" 4BA bolt can easily be used as the terminal. Post 6d.

U.H.F. AERIALS

Streamline 16" blade type with moulded base. 2/ each 3 for 5/-
Post 6d.

De Luxe I.F. TRANSFORMERS

Ex-US Army - Brand new sets of five transformers for AM-FM models S27 & S36 comprising IFT 1, 2 & 3 with variable selectivity IPT's diode coupling, and IPT5 discriminator.

Air-spaced TRIMMERS

IFT4 (T13) Diode coupling
IFT5 (T14) Discriminator

5.2 MC/s

Set of 5 TRANSFORMERS £3.3s. with circuit post free

Many more bargains in latest lists! Free on request.

STAFF CASH SIGNS
G2RI
G3CG5
G3BY1

Flinth RADIOCRAFT Ltd.
69-71 CHURCH GATE-LEICESTER
PHONE 58927

Stockists for DENCO • WODEN • EDDYSTONE RAYMART • BI • LEWCO5 • WHARFEDALE Etc.

MODEL 920

THE TAYLOR POTENTIOMETER

This wire-wound linear law potentiometer is available in a number of resistance values.

- **CONSTRUCTION.** A moulded body carries the spindle, fixing bush, potential brush and connection tags.
- **RESISTANCE.** This is wire wound on a flat strip and fitted after winding to the moulded body.
- **BRUSH.** A well-sprung and insulated brush gives good contact and smooth action under all working conditions.
- **RESISTANCE VALUES.** Standard values available from 10 ohms up to 50,000 ohms
- **WATTAGE.** The maximum dissipation over the whole resistance is 5 watts continuous.
- **FIXING.** A bush is provided for one-hole fixing on panels up to 1/4 in. thick.

TAYLOR ELECTRICAL INSTRUMENTS LTD
419-424 MONTROSE AVENUE, SLOUGH, BUCKS, ENGLAND
Telephone SLOUGH 21381 (4 lines) ● Grams & Cables TAYLINS, SLOUGH

LONDON CENTRAL RADIO STORES

Government Surplus - Immediate Delivery from Stock

EX-R.A.F. CINE CAMERA. Type G45B

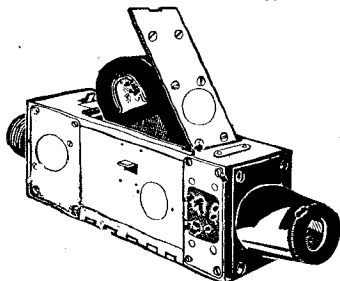

To take 16 mm. film. Fixed focus lens approx 5 cm., f/3.5. The illustration shows loading chamber partly open. In metal case. Dimensions 12 = 3 1/2 = 2in. With 12 v. motor drive **£3**
Spare small 24 v. Motors for above, 8/9.

CHARGING BOARDS. Control Panels Only 24 v. 1,260 watts. Includes five 1 1/2 in. moving coil ammeters (1, 0-40 a., 4, 0-15 a.). One moving coil voltmeter 0-40v. Five heavy duty sliding resistances, etc., complete in Metal case as shown with fold-back doors. Size 18 x 17 x 8 1/2 in. Offered at less than half the component value. Price **£4.19.6**
Carriage extra

NEW 3-VALVE AMPLIFIER PANELS

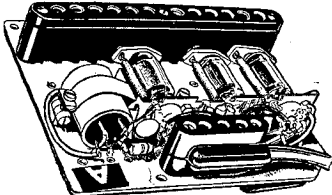

With three IT4 valves, condensers, New spare valves for above 5/- each. **15/-**

EVER READY 5-VALVE AC/DC PORTABLE SETS (Reconditioned). Two wavebands, short and medium. For callers only. **£5.12.6**

S. G. BROWN'S ADJUSTABLE HEADPHONES High resistance. In brand new condition. **28/6**

NEW MILNE'S H.T. UNITS (Everlasting)

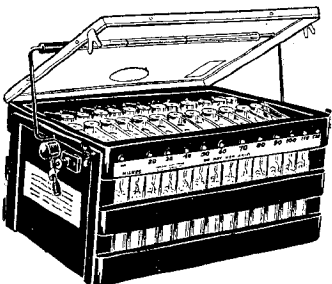

120v. 600 mA. Will charge from 6 v. accumulator **67/6**

10-VALVE RECEIVER Type R. 1355. Containing 8 SP41, 1 VU120 and 1 5U4G valves, complete with 3-valve R.F. unit Type 24. Useful for Television **52/6**

20-VALVE RECEIVER Type No. 3515. Includes strip suitable for Television sound or vision when used in conjunction with R.F. unit Type 25. Contains the following valves: 10 SP61, 5 EF36, 3 EBC33, 1 EB34, 1 Mazda 832, relays, condensers, resistances, etc. Brand new in metal case and supplied in wood transit case **£3.12.6**

The R.F. Unit Type 25 suitable for use with the above and for other television purposes is 22/6 extra.

SINGLE ELEMENT SLIDING RESISTANCES

Super quality, heavy duty. 14 ohms, 5 amps. 17/6.
BLOWER MOTORS 80 v. 50 cycles. A.C. only. 15/-.

METAL RECTIFIERS, 620 v. at 3 mA. 1 1/2 in. long 8/6
CO-AXIAL CABLE, 75 ohms, per doz. yds. 8/-

FIVE-WAY RUBBER COVERED CABLE. Suitable for all purposes. Per doz. yds. 6/-
Ex-Govt. 100ft. COPPER AERIALS, ebonite chain insulators, 30ft. guy rope. 4/3

TELEPHONE LINE OR UNISELECTOR SWITCHES



Brand New. 3-bank Used 33/6.
3-bank, 20/-; 6-bank 25/-.

1/30th H.P. MOTORS. Doubled-ended spindles. 220-250 v. These motors are new, not surplus conversions and are suitable for 16 mm. projectors and many other purposes. A.C./D.C., with feet 57/6
A.C., without feet 52/6

ELECTRO MAGNETIC COUNTERS. Ex-G.P.O., every one perfect, electro-magnetic, 500 ohm coil, counting to 9,999, operated from 25v.-50v. D.C. many industrial and domestic applications. 5/8

MOVING COIL HAND MICROPHONE 5/6

U.S. ARMY MIDGET LIGHT-WEIGHT HEADPHONES. 200 ohms. Suitable for Deaf Aids 15/-

3-VALVE R.F. AMPLIFIERS V.H.F. Type 24. 40/50 mc/s. Complete with 3 SP41 valves. In metal case. Slightly used but in perfect working order. Plus carriage & pkg. 1/6. 10/6

NEW LATEST PLASTIC COVERED WIRE. Red or Black, by Armaduct. 100 yard coil 6/6

VISION UNITS, Model 6A. Consisting of 6in. diameter Electrostatic C.R. tube, 7 valves, including four EF50, potentiometers, resistances and other associated components. In metal cabinet 18 x 8 x 7 1/2 in. These units are in perfect condition. Carriage Paid. **£3.10.0**

PLEASE NOTE

● All carriage paid unless otherwise stated.
● Carriage charges relate to British Isles only. ● We do not issue lists or catalogues. ● We have hundreds of items in stock too numerous to list, so when in Town pay us a visit.

AZIMUTH RELEASE RELAY. In glass fronted, cast aluminium case, size 12 x 4 x 2in. Contains A.C. Relay, D.C. Relay, Alarm Relay, etc. **£2.7.6**
Carr. 1/6

SMALL SLIDING RESISTANCES Ex-Admiralty. Finest quality. Suitable for Voltage Controls, Speed Regulators. 50 ohms, 0.5 amp. Dimensions 6in. x 4 in. x 2 1/2 in. high 8/6

CATHODE RAY TUBES, Ex-Govt. 6in. VCR97 27/6; 6in. VCR517 22/6.

EX-ARMY TEST SET-NEW Type Demolition Mk. 1. For circuit continuity and general testing. In hard wood carrying case 42/-

Type 1154. AIRBORNE G.P. TRANSMITTERS. A few only to clear.

Complete with 4 valves. Frequency coverage: 500 kc/s, 200 kc/s, 10 mc/s, 3 mc/s, 2.35 mc/s, 8 mc/s, 2.5 mc/s. Power input 1,200 v., 200 mA. H.T. 6 v. 4 amp. L.T. Chassis size, 15in. x 13in. x 8 1/2 in. In metal cabinet, easily adapted for Amateur use. Less Power Pack. (See May issue for illustration.)
Carr. & pkg. 10/6 ext. **£10.10.0**

EX-GOVT. TELEPHONE HANDSETS (Sound Power)



New stock. Self-energising. Needs no battery or current. As illustrated 7/6

ROTARY CONVERTERS Input 24 v. D.C. Output, 230 v. 50 cycles. 75 watts. In metal cabinet. Size 18in. x 12in. deep x 1 1/2 in. high.
Carriage paid **£7.15.0**

CALL and INSPECT
our stock of
SPECIAL ADMIRALTY
Transmitters,
Receivers, etc.

SELF-ENERGISING TABLE MICROPHONE & HEADSETS (Sound Power)

The microphone is mounted on a fully adjustable stand with on-off switch. No batteries or current required to operate.

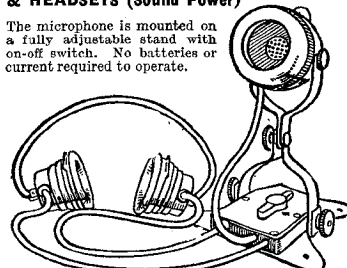

UNUSED IN CARTONS **12/6**

R1155 10-VALVE COMMUNICATIONS RECEIVERS. ONLY A FEW LEFT.

These sets are as new. Freq. range 7.5 mc/s, 75 kc/s in five wavebands. Complete with 10 valves, including magic eye. Enclosed in metal case. Every receiver is aerial tested. Complete with Power Pack and Loud speaker, for A.C. mains 200-250 v. Carr. **£14** paid. (See May issue for illustration.)

FREE with each receiver! Complete circuit, description and modifications for civil use, reprinted from "W.W." July, 1946.

PHOTO-ELECTRIC CELLS Type GS16

These cells are the gas-filled type with caesium Cathode. Made by Cintel. Minimum sensitivity 100µA/lumen, working volts 100 D.C. or peak A.C. Projected cathode area 16 sq. cm. Suitable for 16 mm. Home Cinema Talkie equipment, Safety Devices, Colour and Photo Matching, Burglar Alarms, Automatic Counting, Door Opening, etc. Brand new in original cartons... **42/6**



R.A.F. 6-VALVE SUPERHET RECEIVING UNIT No. 25

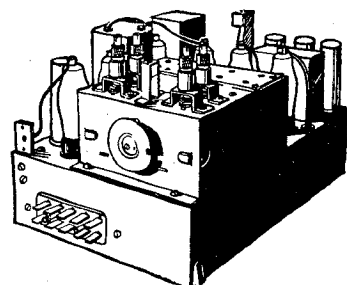

Easily adapted for short-wave reception for home use. Contains two EF36, two EF39, one EK32, one EBC33 valves, condensers, resistances, etc. Free circuit diagram, 9in. x 19in., showing all components, supplied with each set. **25/-**

LONDON CENTRAL RADIO STORES, 23, LISLE ST. (GERrard 2969) LONDON, W.C.2

Closed Thursday 1 p.m. Open all day Saturday and weekdays 9 a.m.—6 p.m.

• CONSTANT VOLTAGE • POWER SUPPLY UNITS

NEW SERIES 101

Our new Laboratory Power Supplies, Series 101, are based on our well-known Model 101-A, but incorporate a number of improvements and refinements.

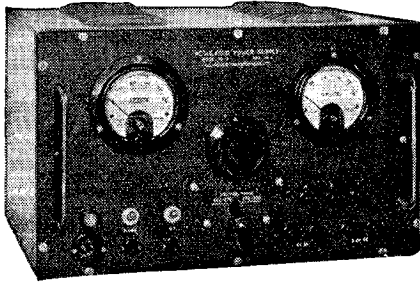

DETAILS ON REQUEST.

ALL-POWER TRANSFORMERS LTD.

8a, GLADSTONE ROAD, WIMBLEDON, S.W.19

Tel.: LIBerty 3303.

THE HEIGHT OF EFFICIENCY IN LONDON OR BIRMINGHAM

WOLSEY

TELEVISION AERIALS

From Single Dipole model to the Triple Reflector model illustrated, every WOLSEY Tele. Aerial is the most efficient of its type. Fifteen years specialisation is behind them.

THE FIRST AND MOST SUCCESSFUL TRIPLE REFLECTOR ARRAY

giving increased gain for fringe areas.

WOLSEY TR/MI. Half Wavelength Dipole with three Reflectors spaced at $\frac{1}{4}$ th wavelength for London, $\frac{1}{2}$ wavelength for Birmingham. Reflector elements positioned in a parabola. Constructed of steel tubing, zinc plated. Duralumin Rods with Polythene V.H.F. insulators and P.V.C. waterproof bushes. Weight only 5½ lbs. As illustrated, £6 list price.



One of our fully equipped Vans available for the installation of all our eight types of Aerials in London and Birmingham.

SEND FOR BROCHURES

WOLSEY TELEVISION LTD,

75, GRESHAM RD., BRIXTON, LONDON, S.W.9

Phone: BRIxton 6651/2

Established 1934

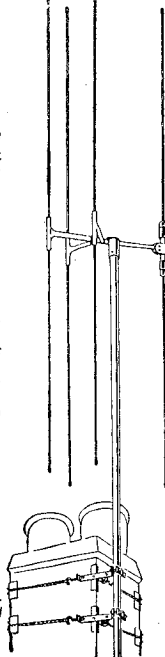

Majestic Winding Co.

Rewinding and Manufacture of Transformers, Coils, Chokes, etc., to the trade.

Suppliers of "To Specification Components" to Research Laboratories, Universities, Local Government Authorities, etc.

NEW TRANSFORMERS

We have a **48 HOUR** service for the supply of ALL types of transformers, chokes, etc., to technical press or your own specification. All components are finished in silver grey and chrome, and can be arranged for any style of mounting. Standard components list available on request.

REWINDS

Our **24 HOUR** rewind service has been used for many years by traders and service engineers throughout the country and has been built upon recommendation. You should avail yourself of this unrivalled service, which includes the supply of price lists, job cards and ready printed address labels, which we shall be pleased to forward upon request.

We are always prepared to modify, or wind to specification, existing components.

All popular mains replacement bobbins available ex-stock. Comprehensive price list available on request.

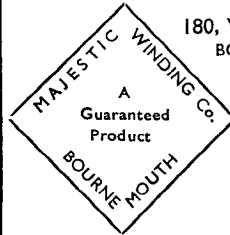

180, WINDHAM RD.,
BOURNEMOUTH,
HANTS.



LAMINATIONS

FOR

All Radio and Electrical Uses.

In Silicon, Dynamo, Intermediate and Transformer Qualities.

Permalloy, Mumetal, Radiometal.

Screens for all Electrical Uses.

Transformer Shrouds for 35 and 74 Lams.

General Precision Engineers.

Heat Treatment.

Sheradising to the Trade.

Electrical Sound & Television Patents Ltd.

12 Pembroke Street, London, N.1. — TERMINUS 4355
2/4 Manor Way, Boreham Wood, Herts. — ELSTREE 2138



VALVES For **SPECIAL PURPOSES**

6F33

RATING

Heater Voltage (volts)	V _h	6.3
Heater Current (amps)	I _h	0.35
Maximum Anode Voltage (volts) ...	V _{a(max)}	250
Maximum Screen Voltage (volts) ...	V _{g2(max)}	250
Mutual Conductance (mA/v)	g _m	* 4.35
Inner μ†	μ _{g1g2}	* 38
Maximum Anode Dissipation (watts)	p _{a(max)}	2.5
Maximum Screen Dissipation (watts)	p _{g2}	0.8
Maximum Potential Heater/Cathode (volts DC)	V _{h-k(max)}	100

*Taken at V_a=200v; V_{g2}=100v; V_{g1}=-1.5v; V_{g3}=0v

†i.e. $\frac{\delta V_{g2}}{\delta V_{g1}}$ with I_a constant

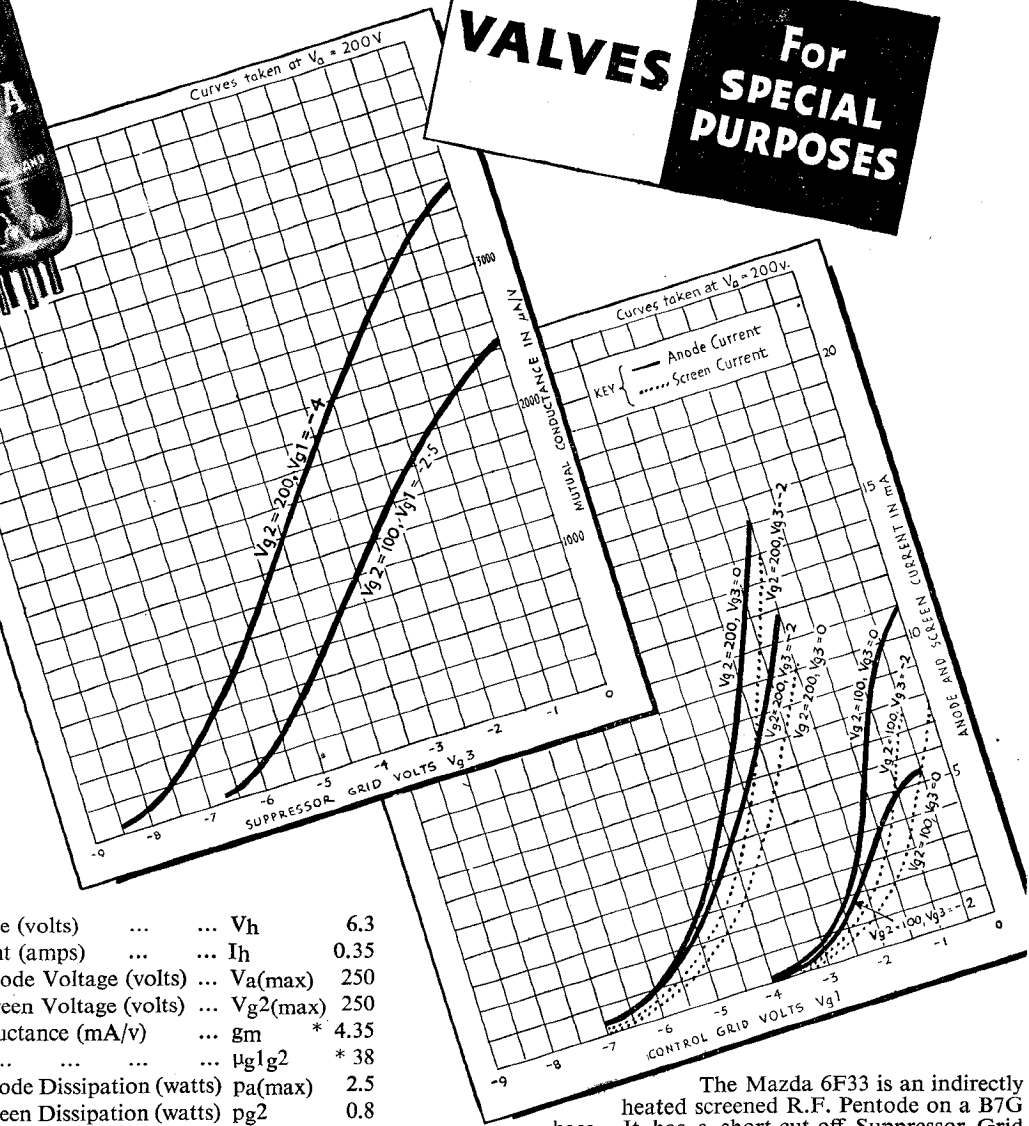

The Mazda 6F33 is an indirectly heated screened R.F. Pentode on a B7G base. It has a short cut-off Suppressor Grid characteristic which makes it particularly suitable for use in Modulator, Variable Reactance and Timing Circuits. In order that the Suppressor Grid may be driven positive, a diode has been tied to this grid. List Price 17/6d.

Further details will be supplied on application to the Radio Division.

EDISWAN

MAZDA

RADIO VALVES AND CATHODE RAY TUBES

Why you should use ...

Superspeed
SPECIAL
Activated
ROSIN CORED SOLDER

- | | |
|---|---|
| 1 Maximum "Wetting" Capacity. | 6 Residue sets hard, is non-corrosive, and of high dielectric strength. |
| 2 Accelerated Fluidity. | 7 No harmful fume deposits. |
| 3 Moderatesoldering bit temperatures. | 8 Continuous, unvarying core. |
| 4 Mechanical bonding and perfect Electrical conductivity ensured. | 9 Even distribution of activator in core. |
| 5 Minimum amount of solder used per joint. | 10 Approved by Air Ministry and General Post Office. |

Supplied in a wide range of Gauges and Alloys on 1 lb and 7 lb reels, works coils, or as required. Prices on application.

Sole Manufacturers:

H. J. Enthoven & Sons, Ltd.

89, UPPER THAMES STREET, LONDON, E.C.4.
Phone: MANsion House 4533. Works: Rotherhithe, Croydon, Derbyshire.

7 Small sizes!

10B

15B

20B

22B

30B

40B

50B

SRc

Our Silvered Mica Capacitors are made in all values between 3 pF and 7000 pF. Our aim is to supply these Capacitors with the smallest possible dimensions, and we have a range of 7 sizes which allows us to offer for almost any capacitance a "made-to-measure" type.

STABILITY RADIO COMPONENTS LTD

14, NORMAN'S BUILDINGS,
CENTRAL STREET, LONDON, E.C.1

Telephone: CLErkenwell 5977

THE SOUND MAGNET £35
TAPE RECORDER & PLAYBACK EQUIPMENT

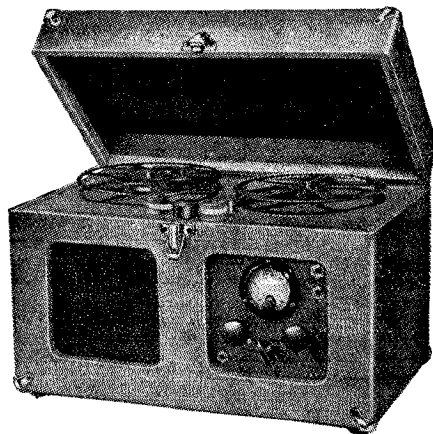

Records on plastic tape, 30 mins. programme. Instant playback with 6v. P.P. Amplifier. Handsome cabinet with internal speaker. Records permanent, or erased, simplicity in operation, certain results.

Full details on the S.M., send 2½d. stamp.

GENERAL LAMINATION PRODUCTS LTD.
S.M. Dept., 294 BROADWAY, BEXLEYHEATH, KENT



**FOR THE
RADIO SERVICEMAN
DEALER AND OWNER**

The man who enrolls for an I.C.S. Radio Course learns radio thoroughly, completely, practically. When he earns his Diploma, he will KNOW radio. We are not content merely to teach the principles of radio, we want to show our students how to apply that training in practical, every-day radio service work. We train them to be successful.

Write to the I.C.S. Advisory Dept. stating your requirements. Our advice is free.

.....You may use this coupon.....

INTERNATIONAL CORRESPONDENCE SCHOOL Ltd.
DEPT. 38, INTERNATIONAL BUILDINGS, KINGSWAY, LONDON, W.C.2

Please explain fully about your instruction in the subject marked X.

Complete Radio Engineering Radio Service Engineers
Radio Service and Sales Advanced Short-Wave Radio
Elementary Electronics, Radar, and Radio

And the following Radio Examinations:—

British Institution of Radio Engineers
P.M.G. Certificates for Wireless Operators
City and Guilds Telecommunications
Wireless Operators and Wireless Mechanics, R.A.F.

I.C.S. Students for Examinations are coached till successful.

Name:..... Age:.....
(BLOCK LETTERS PLEASE)

Address:.....



The most outstanding value ever offered!



Stentorian

BAFFLE SPEAKERS

with a unique combination of features never before possible

In this new range of best-sellers, we have utilised to the full our 25 years' experience of radio reproduction. After twelve months of intensive experiment, we proudly present the finest speaker value ever offered—made possible only by the fact that every operation is carried out in the one organisation. Compare these baffle speakers with any other make on the market: compare their reproduction—their appearance—their price. There can be only one verdict, and we are confident of what that verdict will be.

INCORPORATING REMOTE CONTROL

These speakers are identical in appearance, but "Beaufort" and "Bristol" have push-button remote control, which, in conjunction with the exclusive Whiteley "Long Arm" enables radio to be switched on or off from the speaker. All are finished in highly polished walnut veneer.

● BEAUFORT

Size 12½" x 10½" x 3½". Permanent magnet type speaker (die-cast unit), 6" diameter. Capacity 3 watts. Constant impedance volume control.

Without Trans-former With Trans-former

67/6 75/-

● BRISTOL

Size 10½" x 9½" x 3½". P.M. Unit 6". Capacity 3 watts. Constant impedance volume control.

53/6 59/6

● BEDFORD

Size 9½" x 8½" x 3½". P.M. Unit 5". Capacity 2½ watts. Complete with volume control.

39/6 45/6

NO PURCHASE TAX

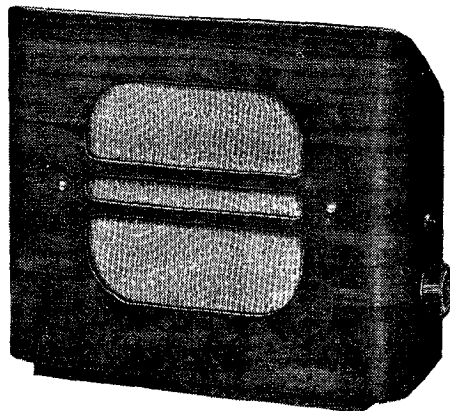

★ ASK YOUR LOCAL DEALER TO DEMONSTRATE

WHITELEY ELECTRICAL RADIO CO. LTD · MANSFIELD · NOTTS

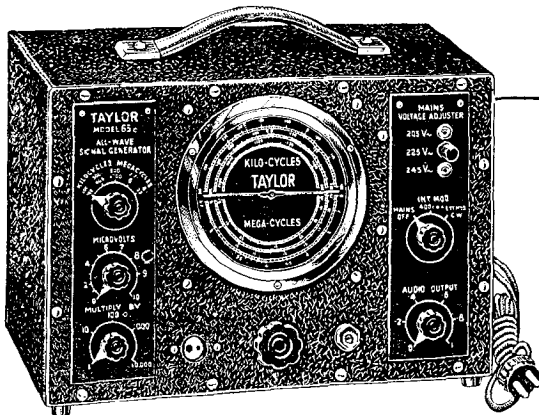

THIS NEW SIGNAL GENERATOR COVERS

100 Kc/s TO 160 Mc/s

- 7 ranges. Six covering 100 Kc/s to 80 Mc/s on fundamentals and the seventh 80 Mc/s to 160 Mc/s on 2nd harmonic.
- Accuracy better than 2% on all ranges.
- Scale calibrated in Kc/s and Mc/s with total length of 30 ins.
- 400 cycle internal or external modulation.
- Both coarse and fine R.F. attenuation available.
- Up to 1 volt of 400 c/s Audio output available.
- Direct radiation reduced by mains filter.
- A.C. mains operated. Voltage adjustment covers 110 V and 200-250 V. 40/100 c/s.

MODEL 65C. This new mains operated Signal Generator has been designed by a highly skilled team of Taylor development engineers. It is an accurate, reliable, and compact instrument which meets all the requirements of present-day practice. Furthermore, future developments in the television field have been met by the wider frequency ranges which hitherto were confined to expensive instruments of the Laboratory type.

LIST PRICE
£17 . 15 . 0

Please write for further details and information on other WINDSOR and TAYLOR Products.



OTHER PRODUCTS INCLUDE: MULTIRANGE A.C. D.C. TEST METERS • SIGNAL GENERATORS • VALVE TESTERS • A.C. BRIDGES • CIRCUIT ANALYSERS • CATHODE RAY OSCILLOGRAPHS • HIGH AND LOW RANGE OHMMETERS • OUTPUT METERS • INSULATION TESTERS • MOVING COIL INSTRUMENTS

TAYLOR ELECTRICAL INSTRUMENTS LTD
419-424 MONTROSE AVENUE, SLOUGH, BUCKS, ENGLAND

Telephone: Slough 21381 (4 lines)
Grams & Cables: Taylins, Slough

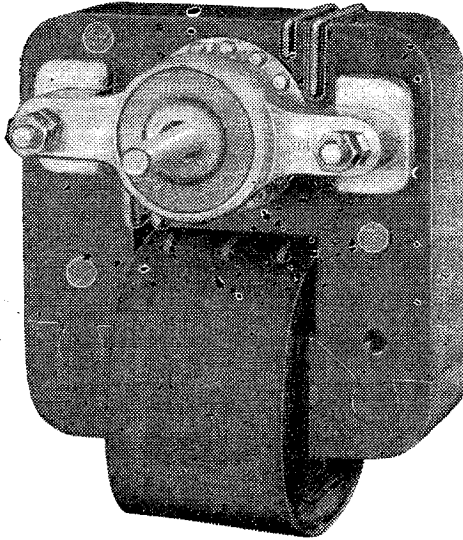

Shaded Pole

Motor

Model S.R.2.

A rugged and highly efficient Motor, giving an amazing performance at an economical price. It will stand heavy overloads, and for intermittent ratings is capable of giving up to twice the above power.

Carefully tested for balance, and individually put through a Silent Room test, this motor is ideal for Gramophone Motors, Wire and Tape Recorders, Fans, Motion Displays, Switch Movements, Timing Mechanisms, and many other applications.

List Price 25/-

SPECIFICATION

200-220/230-250 volts, 50 cycles.	Other voltages and frequencies available.	Under 30°C. Rise. Continuous rating.
Stack Thickness	0.675"	0.875"
Watts (Light)	17	21
R.P.M. (Light)	2750	2750
Starting Torque (in. ozs.)	1.7	2.3
Full Load Torque (in. ozs.)	2.0	3.0
Full Load R.P.M.	2000	2000
Weight	1.7 lbs.	2.31 lbs.
Shaft Dia. 0.1875" Steel Centreless Ground.		
Bearings: Graphite Bronze Oilless type, Self Aligning.		
Rigid Diecast Bearing Brackets. Vacuum Impregnated Layer Wound Coil.		



Birmingham Sound Reproducers Ltd.

Claremont Works, Old Hill, Staffs. Phone Cradley Heath 6212/3.

Wireless World

RADIO AND ELECTRONICS

JUNE

1949

39th YEAR OF PUBLICATION

Proprietors: ILIFFE & SONS LTD.
 Managing Editor: HUGH S. POCKOCK, M.T.E.E.
 Editor: H. F. SMITH

Editorial, Advertising and Publishing Offices:
 DORSET HOUSE, STAMFORD STREET
 LONDON, S.E.1.

Telephone: Waterloo 3333 (60 lines).
 Telegrams: "Ethaworld, Sedist, London."

PUBLISHED MONTHLY

Price: 2/-

(Publication date 26th of preceding month)

Subscription Rate: 26/- per annum. Home and Abroad

Branch Offices:

Birmingham: King Edward House, New Street, 2.
 Coventry: 8-10, Corporation Street.
 Glasgow: 26B, Renfield Street, C.2.
 Manchester: 260, Deansgate, 3.

In This Issue

OUR COVER: Massed Television Transmitters (See Page 205).

EDITORIAL COMMENT	201
CATHODE-RAY TUBES FOR TELEVISION. By Hilary Moss	202
PARASITIC OSCILLATIONS. By "Cathode Ray"	206
CONTRAST EXPANSION. By L. J. Wheeler	211
"Q"-METER CONTROVERSY	216
DISTORTION IN F.M. By Thomas Roddam	218
WORLD OF WIRELESS	221
"MIDGET A.C. MAINS RECEIVER"	224
ELECTRONIC CIRCUITRY. By J. McG. Sowerby	225
RECTIFIER VOLTAGE CONTROL. By F. Butler	227
BLOCKING OSCILLATORS. By W. T. Cocking	230
UNBIASED. By "Free Grid"	234
LETTERS TO THE EDITOR	235
SHORT-WAVE CONDITIONS	237
RANDOM RADIATIONS. By "Diallist"	238
RECENT INVENTIONS	240

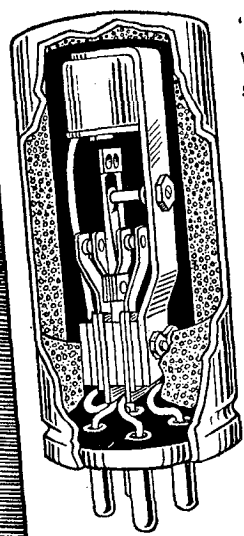

"Stratosil" fully sealed vibrators are supplied in synchronous, non-synchronous and split-reed synchronous types. Being available in both shunt and series drive (the latter being made under "OAK" patents) they offer a replacement service for the majority of American-pattern vibrators as well as covering fully the needs of the designer of new equipments.

WEAIRE VIBRATORS

set the standard for efficiency

A data book, complete with replacement guide and transformer design information is now ready and will be gladly sent to you at 6d. post free. Please use the coupon.

POST THE COUPON NOW

Wright & Weaire, Ltd., 138 Sloane Street, London, S.W.1, England

Please send me VIBRATOR DATA BOOK for which I enclose 6d.

Name and Address

.....

.....

WW 549

Wright and Weaire Limited

138, SLOANE ST. LONDON · S.W.1 TEL SLOANE 221415 FACTORY: SOUTH SHIELDS, CO. DURHAM

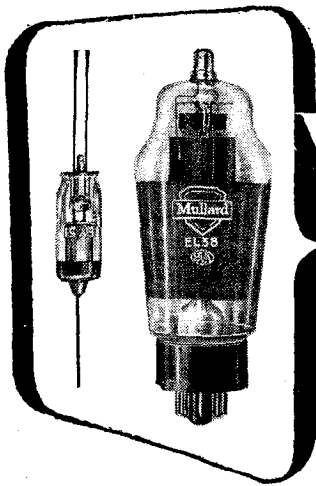

Valves and their applications

E.H.T. FROM THE LINE TIME BASE FLYBACK

It is well known that line time base amplifiers produce very high voltages across the output transformer during the flyback; the utilization of this pulse to

provide an E.H.T. supply is most economical and, for direct-viewing tubes, gives a simple and satisfactory solution. It is desirable that the source impedance shall not be greater than 5 MΩ and voltage doubling, which is also more expensive, is therefore excluded.

The value of the reservoir capacitance C3 may be as low as 100pF and the capacitor is connected so that

the primary of the output transformer. The overwind reduces the contribution of the output capacitance of the EL38 to the total effective capacitance across the whole winding. It also increases the flyback time, which, with the low capacitance, would be unnecessarily fast and thereby minimizes the losses in the magnetic circuits.

Since the energy stored in the inductive components at the beginning of the flyback is largely determined by the scan requirements of the deflector coils, the E.H.T. voltage developed is controlled by the stray capacitances across the transformer. These are therefore reduced by using air as the dielectric medium between the high-voltage windings and the laminations and also by choosing a lamination with a sufficiently large window to allow good spacing. This also increases the insulation of the windings.

Fig. 1 shows a conventional line time base amplifier circuit, modified for E.H.T. generation. It will be noted that an inductor L1 has been added to the conventional resistance-capacitance damping circuit. Its effect is to oppose the build-up of current in the damping resistors as the beginning of the flyback, thus reducing the damping and giving a higher pulse voltage. Subsequently, it tends

while the EY51 is conducting, a negative-going pulse from the secondary winding is applied to the low potential plate. This increases the D.C. voltage across C3 but necessitates a resistor R3 to prevent the capacitance of the C.R. tube from shunting the deflector coils.

It is important that the EL38 be rapidly and completely cut-off from the beginning of and throughout the flyback. C1 and C2 both help to achieve this. C1 feeds back a negative-going pulse from the deflector coils; C2 increases the grid-cathode potential during the flyback by temporarily removing the negative feed-back.

Reprints of this report from the Mullard Laboratories, together with additional circuit notes and full transformer winding data can be obtained free of charge from the address below.

MULLARD ELECTRONIC PRODUCTS LTD.
TECHNICAL PUBLICATIONS DEPARTMENT,
CENTURY HOUSE, SHAFTESBURY AVE., W.C2
 (MVM91)

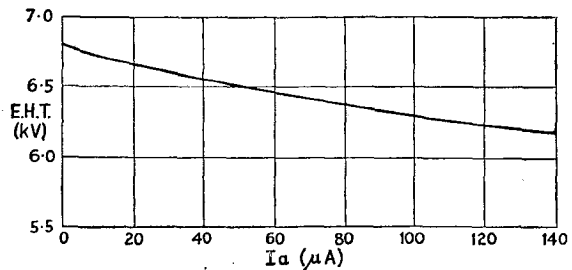

REGULATION CURVE OF E.H.T. SUPPLY

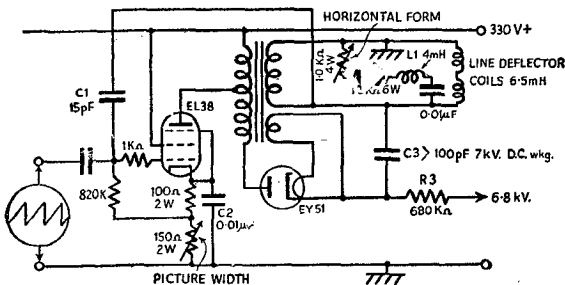

FIG. 1

LINE TIME BASE AMPLIFIER I_a=75mA I_{g2}=17mA.

to maintain the current and increases the effectiveness of the damping resistors during the later part of the flyback. The rectifier (EY51) is connected to an overwind on



Wireless World

VOL. LV. NO. 6

JUNE 1949

RADIO AND ELECTRONICS

MONTHLY COMMENTARY:

Radio Politics

EVER since we published the Copenhagen Plan list of broadcast frequency allocations for Europe in our issue of November 1948, readers have deplored the fact that politics were allowed to enter so largely into the making of decisions that should be influenced mainly by technical considerations, geography and distribution of potential listeners. In most of the letters written on this subject it is suggested that sooner or later those countries—in particular Germany and Spain—that have been given unfavourable allocations will encroach on channels belonging to other countries and will become, in effect, ether pirates. Spain, we are reminded, was given two clear channels under the still-born Montreux plan, but is now to have none. According to a correspondent, the number of receivers in use has increased five-fold since 1939. Germany, considering the high listener density of pre-war days, is almost certainly in an even worse position.

IN the sphere of short-wave broadcasting international co-operation has apparently been similarly bedevilled by political differences, though it is as yet too early to comment on the outcome of the International High-frequency Broadcasting Conference at Mexico City. We may be permitted a sigh in recollection of the "good old days" of 1938 and the Cairo Convention. We were proud of the fact that radio men could then—in a world already riddled with political jealousies but probably more civilized than the present one—settle their problems on a predominantly technical and rational basis.

As recent international deliberations on radio matters have had such an unfruitful outcome it is perhaps inopportune to press for discussions at a higher level than hitherto on the possibilities of uniformity in television for Europe, or at any rate for Western Europe. But no country except France has so far made a definite statement on the

standards to be adopted, and it would be a counsel of despair to say that nothing can be done to devise means of bringing about some measure of agreement on matters that are bound to influence the healthy growth of television.

WE are reminded of the present unsatisfactory state of affairs by reading an article in *La Radio Française* by the outspoken and often provocative Editor, Marc Chauvierre, who ventures a forecast of the television systems to be ultimately adopted. They are: 819 lines for France and perhaps Belgium and Switzerland; 625 lines for England, Sweden, Norway, Denmark and Western Germany; 525 lines for Italy "which is equipping herself with television under Marshall Aid," and possibly Spain.

With the details of this forecast we obviously cannot agree, if only for the fact that 625 lines has limited acceptance in England as an export standard only; for home consumption we are committed to 405 lines for some years. However, we do agree that, failing some effective action, Europe may well find herself saddled with a diversity of standards which will make exchange of programmes difficult or impossible and will make international trade even more difficult. The organizing of services in neighbouring countries so as to avoid interference is also a matter that calls for international discussion.

We are still in agreement with M. Chauvierre when he goes on to press on economic grounds for a standard of moderate definition "of the order of 500 lines" for domestic—as opposed to cinema—use. Europe cannot afford to experiment in costly elaborations of doubtful value.

Radio in all its branches—not excluding the visual-range frequencies—is a truly international matter, and its growth will certainly be hampered if effective international co-operation in its organization is lacking.

CATHODE-RAY TUBES FOR TELEVISION

Operating Conditions v. Picture Brightness

By **HILARY MOSS**, Ph.D., M.Brit.I.R.E. (Chief Engineer, Electronic Tubes, Ltd.)

In this article answers are given to two problems which are often encountered in television. The first is: In a given television system with a constant number of lines, what increase of c.r. tube voltage is needed to maintain constant brightness as the screen diameter is increased assuming (a) constant resolution at the screen and (b) constant spot size? The second problem is: What increase of tube voltage is needed with a given tube to maintain constant brightness as the number of scanning lines is increased, the frame frequency being unchanged?

In these, as in all cathode-ray tube problems, the solutions depend on the assumptions made. In the first part of the article it is assumed that the neck diameter is variable and answers are given depending on whether the beam current or cathode loading is constant. The methods are then extended to cover the case of constant neck diameter.

THERE is a wide-spread impression that the cathode-ray tube designer lives in an atmosphere of Hamiltonian mechanics, phase space, Liouville's theorem and the Principle of Least Action. These abstruse matters have a part to play in the higher realms of the subject—into which the author has never yet penetrated—but it is surprising how much can be done by a combination of logical thinking, simple experiment and fourth-form algebra. Broadly speaking, the higher branches of electron optics are called into play only if we seek to design from first principles. This task calls for superb mathematical ability and is, in any case, of doubtful practical value owing to the manipulative difficulties which arise.

On the other hand, if we are content to design by reference to existing practice, then an enormous simplification can be made. It is possible to set up simple but far reaching relationships between the *relative* characteristics of various types of cathode-ray tube. Therefore, if the absolute characteristics of one tube—the reference tube—are measured, the absolute performance of the other tubes can be computed from the relations established.

The simple laws relating the performance of one tube to another are, of course, approximate only and so the method has one fundamental limitation. It is necessary to be careful not to extrapolate too far or the predictions made may be seriously in error. It is also important to have

sufficient appreciation of the physics behind the phenomena which the laws illustrate to be fairly sure that discontinuities in the nature of the laws are unlikely. For example, in the case of brightness/voltage curves we must be sure that any extrapolation made does not extend into the region of "screen sticking."

The sketches of Fig. 1 show diagrammatically the basic form of a typical television c.r. tube having a triode gun and designed for magnetic focusing and deflection. As shown at (a), the electron beam is generated in the triode T, focused by the lens F on to the screen at S and deflected by the coils D. The lens F may be either a permanent magnet, or excited coil, or a combination of both. In an electron-optical sense these distinctions are of no account whatever, provided that in each case the lens is capable of handling the maximum beam diameter (i.e., that at "full white") without appreciable aberration.

Fig. 1. The general form of a typical magnet c.r. tube is sketched at (a) and an exaggerated view of the electron beam at (b). In the latter the crossover is at T and the magnetic lens at XY.

An elaborated view of the electron trajectories is shown at (b) but with the beam width greatly expanded for clarity; k is the cath-

ode surface (usually plane), g is the grid or modulator and a the anode. These three elements constitute what is usually known as the "triode." The anode a is normally joined to the graphite wall-coating of the tube. It sometimes contains a second orifice which serves to trim the beam, so preventing the width of the latter from exceeding a defined value. Alternatively in some constructions the electrode a is omitted entirely and its place taken by the coated walls of the tube. Although these variations affect many of the details of the operation of the whole gun, they do not affect the basic arguments presented in this article.

The full details of the operation of the triode are immensely complicated, and even today are not fully understood. Luckily for our purpose we do not need to enquire too closely into them. It is sufficient to accept that the fields in the triode generate a conical beam

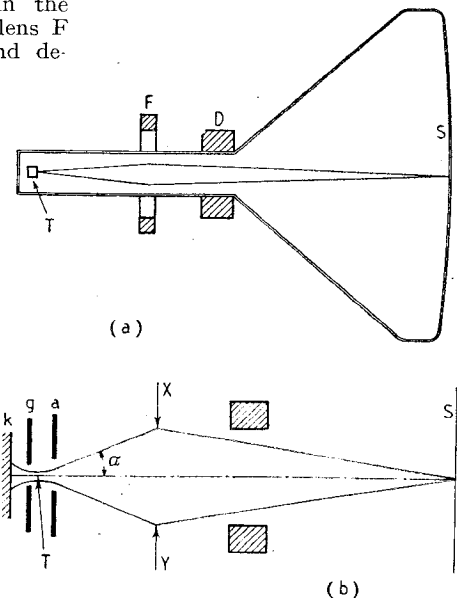

of electrons as indicated in Fig. 1 (b) which appears to emerge from a small area marked T and usually referred to as the "cross-

over." This crossover is the object which the focusing lens F images on the screen S . For simplicity this lens is assumed to be infinitely thin and to act at the plane XY . Since the field of the lens has an appreciable spread along the axis of the gun this assumption is not strictly accurate but the subsequent working is in no way affected.

It can be shown that owing to the Maxwellian velocity distribution in the electrons emitted from the thermionic cathode k , the edge of the crossover is not sharply defined. In fact, detailed analysis shows that to a close approximation the electron-density distribution in the crossover has the form shown in Fig. 2—a curve of Gaussian shape.

Physically speaking this means that if we are to speak of "crossover diameter" it is necessary to define a convention which will give this phrase a meaning. The most satisfactory mode of doing this is illustrated in Fig. 2. A straight line is drawn parallel to the X axis at some arbitrary percentage of the maximum and the crossover diameter is then defined as the distance XY . The exact percentage is not important, being largely a matter of convention but a common value is 20% if precise quantitative measurements are being undertaken. However, such measurements are extremely difficult and are rarely made.

The lens F merely serves to image this distribution of electrons on the screen S . In general the scale of the distribution will, of course, be different just as in light optics. In this discussion, incidentally, it is assumed that there are no lens aberrations and that space charge is negligible. If these postulates are not satisfied the shape of the distribution at the screen will not be the same as that at the crossover.

It is unnecessary here to enter into any discussion whatever as to the effect of deflecting the beam, since for the moment the ratio beam width/deflector-coil size, the shape of the deflector coils, and the maximum scanning angles will all be maintained constant. Manipulation of the various relationships in television-gun design become appreciably more involved if these conditions are not satisfied.

Many problems connected with

the picture size and brightness can be solved by the application of the laws stated in the following five postulates. It is unnecessary to show here how these are derived, but in order to indicate the reasoning behind them some account is given in the Appendix. These postulates are: (1) If all dimensions of an electron-optical system are multiplied by k , all applied voltages being held constant, then the total current flowing is unchanged and the shape

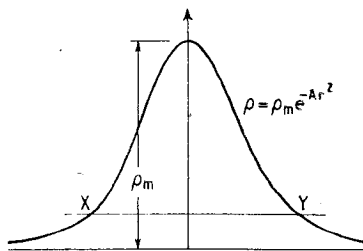

Fig. 2. This Gaussian curve shows the electron density ρ in a cross-section of the beam at the crossover.

of the trajectories is also unchanged, although on a scale k times as large. In other words the systems transform perfectly—all angles being unchanged. This statement is *absolutely exact* if the electrons of the system start from rest and applies even in the presence of space charge. (2) In any electron-optical system of constant geometry, if *all* electrode voltages are multiplied by k , and all magnetic field intensities by \sqrt{k} , the electron trajectories are unchanged. This statement is again *absolutely exact* if space charge is neglected and the electrons in the system start from rest. (3) If the average current density at the screen is kept constant, the screen brightness is proportional to some power of the electron voltage; i.e., to the velocity of impact. It is proportional to V^n where V is the anode voltage of the tube. In this statement it is assumed that the integration time for determining the average current density is too short for flicker effects to be noticeable. (4) If all anode voltages in a tube are multiplied by k , then the spot diameter is inversely proportional to \sqrt{k} . This is an approximation only but is a good one, especially if the beam angles in the gun are

maintained constant by making a corresponding change in the grid voltage whenever the anode voltages are changed.

(5) If two triodes, *physically identical except for their cathode grid spacings*, are operated at different anode voltages such that their cut-off voltages are equal, then to a fairly close approximation the modulation characteristics both in respect of current and beam angle, are identical. The cut-off voltage is, of course, the grid voltage for which the anode current just becomes zero.

Provided that the beam current is kept constant these postulates enable a number of important practical problems to be solved. One common one is: Suppose that we have a certain tube, tube 1, with a certain screen diameter, what operating voltage will be needed for another tube, tube 2, of k times the diameter if the brightness and resolution of the picture are to be unchanged?

Using subscripts 1 and 2 to refer to conditions in tubes 1 and 2, from postulate (3) the surface brightness of the original tube is proportional to V_1^n/A , where A is the screen area, and the surface brightness of the derived tube will be V_2^n/k^2A . Hence for equality of screen brightness it follows that

$$V_2^n = k^2 V_1^n \dots (1)$$

where n is a constant (see Appendix).

This equation (1) satisfies the condition maintaining constant brightness. We next investigate the spot size. The original spot diameter, using postulate (4), is proportional to $1/\sqrt{V_1}$ and the spot diameter on the derived tube will be proportional to $1/\sqrt{V_2}$, but we require to have an arbitrary control over the spot size independent of that imposed by postulate (4). This is most simply done by using postulate (1) and multiplying the linear dimensions of the triode *only* by λ . Thus the spot diameter of the original tube is proportional to $1/\sqrt{V_1}$ and the spot diameter of the derived tube is proportional to $\lambda/\sqrt{V_2}$. But we require constant resolution at the screen (i.e., the same ratio of spot diameter to screen diameter in both tubes) so that on the derived tube with a screen diameter k times as large as on the reference tube, the spot diameter must also

Cathode-ray Tubes for Television— be k times as large as on the reference tube. Thus we derive the equation

$$\lambda/\sqrt{V_2} = k/\sqrt{V_1} \dots (2)$$

which gives us freedom to adjust the spot size appropriately.

Solving (1) and (2) gives us $\lambda = k^{(1+1/n)}$ which defines the linear scaling factor for the triode.

In order to make the modulation characteristics of the two tubes identical we now merely employ postulate (5) and adjust

the cathode/grid spacing of the derived tube so that it operates at the same cut-off voltage as the reference tube (to a close approximation the cut-off voltage is inversely proportional to the cathode/grid spacing). Thus the problem is completely solved. Taking a numerical example, suppose we wish to double the diameter of the screen, then assuming the index n equals 2, which is a good average value (see Appendix), it follows $\lambda = 2^{3/2}$. Thus

all the dimensions of the tube are multiplied by 2 except for the triode which is multiplied by 2.83. From postulate (4) the anode voltage is multiplied by 2. This will result in a picture of twice the linear dimensions and of the same surface brightness, the voltage of the tube being doubled. The spot size is also doubled so that the resolution is unchanged.

If, instead of making the spot size proportional to the screen size, we decide that the spot size must

Basic Operation		Screen diameter multiplied by k				No. of lines multiplied by μ . Tube dimensions constant	
Secondary Operations		All linear dimensions of bulb, neck and scanning coils multiplied by k				Triode only scaled	
Geometrical Changes made	Triode Dimensions	$\times k^{(1+1/n)}$	$\times k^{1/n}$	$\times k$	$\times k^{1/(1+n)}$	$\times \frac{I}{\mu}$	$\times \frac{I}{\mu^{n/(n+1)}}$
	Cathode-grid spacing*	$\times k^{2/n}$	$\times k^{2/n}$	$\times \frac{I}{k^{4/3}}$	$\times k^{2/3(1+n)}$	$\times I$	$\times \mu^{(6+4n)/3(n+1)}$
Electrical changes made	Anode Voltage	$\times k^{2/n}$	$\times k^{2/n}$	$\times I$	$\times k^{2/(1+n)}$	$\times I$	$\times \mu^{2/(n+1)}$
	Cut-off Voltage	$\times I$	$\times I$	$\times k^{4/3}$	$\times k^{4/3(1+n)}$	$\times I$	$\times \frac{I}{\mu^{4n/3(n+1)}}$
	Grid Drive	$\times I$	$\times I$	$\times k^{4/3}$	$\times k^{4/3(1+n)}$	$\times I$	$\times \frac{I}{\mu^{4n/3(n+1)}}$
	Scanning-coil Current	$\times k^{1/n}$	$\times k^{1/n}$	$\times I$	$\times k^{1/(1+n)}$	$\times I$	$\times \mu^{1/(n+1)}$
Effects produced	Beam Current	$\times I$	$\times I$	$\times k^2$	$\times k^{2/(1+n)}$	$\times I$	$\times \frac{I}{\mu^{2n/(n+1)}}$
	Spot Diameter	$\times k$	$\times I$	$\times k$	$\times I$	$\times \frac{I}{\mu}$	$\times \frac{I}{\mu}$
	Beam Angle α	$\times I$	$\times I$	$\times I$	$\times I$	$\times I$	$\times I$
	Screen Brightness	$\times I$	$\times I$	$\times I$	$\times I$	$\times I$	$\times I$
	Cathode Loading	$\times \frac{I}{k^{2(1+1/n)}}$	$\times \frac{I}{k^{2/n}}$	$\times I$	$\times I$	$\times \mu^2$	$\times I$

* This adjustment to be made additionally to that effected by the scaling of the whole triode.

be kept constant, the answer is different. Equation (1) still applies to satisfy the condition of constant brightness, but to satisfy the condition of constant spot size $\lambda/\sqrt{V_2} = \tau/\sqrt{V_1}$. The solution of these equations gives $\lambda = k^{1/n}$. Taking again the case of doubling the screen size, this means that we must multiply the triode dimensions by $\sqrt{2}$ only in order to achieve constant spot size. The anode voltage again is doubled.

In both these solutions *all the rest of the tube geometry* apart from the triode has its linear dimensions multiplied by k .

Deflection System

We must now enquire what changes are needed in the deflection system. These follow at once from postulate (2). It is merely necessary to multiply the coil current by \sqrt{k} since the anode potential has been multiplied by k . This applies to both problems.

Let us now suppose the number of lines is to be multiplied by μ , what changes in tube design are necessary? One possible solution of this problem is exceedingly simple. Since the total light output from the screen must be constant if the integrated energy delivered to the screen is also constant, it follows that merely increasing the number of lines in the system does not necessarily entail an increase in anode voltage and beam current. All we need to do is to reduce the spot diameter in proportion to the increase of the number of lines. Thus, applying postulate (3), the simplest solution consists of merely multiplying all dimensions of the triode by $1/\mu$ and keeping all voltages constant. This will satisfy all the imposed conditions. Thus, increasing the number of lines from 400 to 600 will require that the linear dimensions of the triode are multiplied by $2/3$ and no other change is necessary. This is the simplest possible solution.

In the methods so far used it must be carefully noted that we have kept the total beam current and beam angle constant, adjusting the spot size where necessary by scaling the triode gun. It is obvious, therefore, that the cathode loading (the current extracted per unit area from the cathode) has varied inversely as the area

of the cathode; i.e., as μ^2 . In the last problem, therefore, the cathode loading has been multiplied by the factor $9/4$ and this fact may make the solution not practically acceptable on account of reduced cathode life.

It is quite possible to inject another postulate into the reasoning; viz., that the cathode loading should be held constant and the beam current allowed to vary. This involves a more complicated treatment and one additional postulate. This is that the screen brightness is proportional to the average current per unit area over its surface.

Hence the condition of constant screen brightness now requires

$$k^2 I_1 V_1^n = I_2 V_2^n \dots \dots \dots (3)$$

By way of illustration we shall treat the first problem again where the resolution at the screen is constant.

Equation (2) applies. But to obtain constant cathode loading it is necessary that

$$I_2/I_1 = \lambda^2 \dots \dots \dots (4)$$

This is not, however, a sufficient condition. In addition we must arrange that the fraction of the cathode surface which is emitting is the same as previously. This is equivalent to securing constancy of beam angle α , Fig. 1 (b). From Fig 4 (in the Appendix), this requires

$$V_{d1}/V_{c1} = V_{d2}/V_{c2} \dots \dots (5)$$

where V_d is the grid voltage measured with respect to the cut-off grid voltage V_c .

We also need the law connecting current and voltage. It has been shown elsewhere¹ that to useful engineering accuracy the cathode current

$$I_k = 3 V_d^{7/2}/V_c^2 \dots \dots \dots (6)$$

where I_k is in microamperes and potentials are in volts. Therefore

$$\frac{I_2}{I_1} = \left(\frac{V_{d2}}{V_{d1}}\right)^{7/2} \left(\frac{V_{c1}}{V_{c2}}\right)^2 \dots \dots (7)$$

The solution of this system of equations gives the results shown in the 3rd row of Table 1. Exactly similar methods give the solutions of the other two problems. These are also shown in Table 1 together with the simpler solutions of constant beam current previously considered.

Comparing rows 1 and 3 it can be seen that instead of increasing the anode voltage $k^{2/n}$ times and

¹ "Electron Gun of the Cathode Ray Tube—Part 2," by H. Moss, *J. Brit. Instn. Radio Engrs.*, June, 1946.

OUR COVER

TELEVISION EN MASSE. The forest of towers forming the subject of this month's cover illustration includes the aerials of six American television stations. They are at the summit of Mount Wilson (5,700 feet), which is some 25 miles from Los Angeles, California. Each of the transmitters operates, of course, in a different television channel varying from 66 to 216 Mc/s. The remaining two towers shown in the illustration are for an f.m. transmitter and a relay station of the Pacific Telephone and Telegraph Company.

working at constant beam current, the voltage can remain unchanged and the current increased k^2 times. The cathode loading in the large and small tubes is then the same. The deflector coil current is now unchanged instead of being multiplied by $k^{1/n}$.

When discussing the use of a given tube for an increased number of lines it was said that only the triode gun need be changed to give the reduced spot size but that as a result the greater cathode loading might be dangerously high. An alternative tube would be one operating at the normal cathode loading (Row 6, Table 1). This requires $\mu^{2/(n+1)}$ times the anode voltage and $\mu^{1/(n+1)}$ times the deflector-coil current.

If 5kV gives adequate brightness with 405 lines and the factor n is 1.67, then with 625 lines the anode must be operated at $(625/405)^{2/2.67} = 1.545^{0.75} = 1.39$ times the voltage or 7kV. The deflector-coil current must be 1.18 times as great. The back e.m.f. across the deflector coil is μ times as great for the same current because of the increased velocity of scan, and taking the greater current into account it is $\mu^{2/(n+1)}$ times as great or 1.39 times. The power in the scanning generator thus increases by $1.39 \times 1.18 = 1.64$ times. These figures agree well with practice.

(To be concluded)

PARASITIC OSCILLATIONS

Some Predisposing Conditions and How to Avoid Them

By "CATHODE RAY"

IT is quite usual for published valve circuits to include components that seem to serve no useful purpose. Inquisitive or thrifty experimenters try leaving them out, and when no obvious harm befalls they rejoice in having saved a component, or in having "put one over" the designer. These happy thoughts may possibly be clouded by some uneasiness lest, after all, the designer may have known better. The commonest example of such a component is a resistor in series with the grid. Sometimes the author may briefly explain its presence by a reference to "parasitic oscillation." But the principle, if any, on which the value of resistance is decided is generally left very vague. In fact, vagueness is often the outstanding feature about this parasitic business. How can one tell whether anti-parasitic precautions will be necessary or not? What will happen if they are necessary and are not adopted? And if they are necessary, how are their details decided?

Parasitic oscillation, in its broadest sense, is unwanted oscillation. But the principles that govern oscillation are the same whether it is wanted or not. After all, how is an oscillation to know the difference? Although those principles are well known, let us review them, to see how they can work to our disadvantage as well as to our benefit.

There are several ways in which oscillations can be generated, but by far the most important is by a combination of amplification and feedback. The reason why valves are usually involved is their almost unique ability to supply the amplification. That part of the matter is so well known that I will take it for granted; but the feedback may need more detailed discussion, because in the case of parasitic oscillation it will generally exist unawares.

this means, consider *any* amplifier and coupling, represented by the "boxes" in Fig. 1(a). (This method of representing them is merely in order to cover all possible arrangements, and certainly not to suggest that they must always be elaborate pieces of apparatus. The coupling might be merely stray capacitance or mutual inductance).

Imagine that the source of alternating input voltage can be adjusted to any frequency, from zero to microwaves. If the resulting voltage across the coupling is compared with the input, it may be found that at one or more frequencies it is exactly in phase and equal in amplitude. At such frequencies, then, it is equivalent to the source of input voltage, and can be substituted for it, as in Fig. 1(b). Provided that the impedance conditions are not thereby upset, the amplifier will go on generating an alternating voltage without any outside source; it is, in fact, oscillating.

As I explained in connection with negative feedback,* there is no need for the feedback voltage to start off by being equal to the input in amplitude. It is very unlikely to be *exactly equal*, but it may easily be greater, in which case it will make the oscillation grow until the amplifier overloads sufficiently to cut down its gain to exactly zero (i.e., voltage amplification = 1). So it doesn't matter how small the original voltage is; in fact, there is no need for any outside source even to start the oscillation going—the minute "thermal agitation" voltages present in every circuit are enough.

When designing valve apparatus for particular frequencies or bands of frequencies, one can very easily overlook its possibilities at

* "When Negative Feedback Isn't Negative," May, 1949 issue.

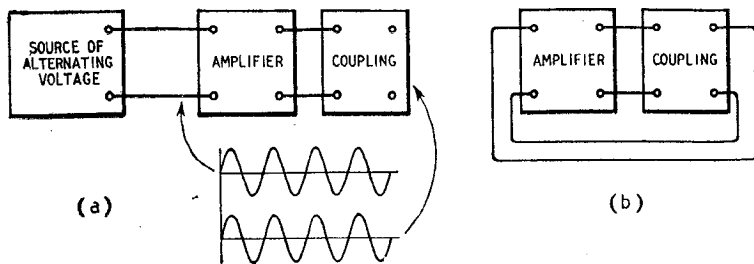

Fig. 1. If an alternating voltage is applied to an amplifier, some frequency or frequencies can generally be found at which the output is exactly in phase with the input, and at least equal in voltage. When that happens, the output can be substituted for the input and the amplifier will become a self-oscillator. If the back-coupling is unintentional, the oscillation is described as parasitic.

The difficulty about giving crisp and clear answers to these questions is that they cover such a variety of circumstances. A doctor would need more than a minute or two to answer them about his sort of parasites, but the radio kind are more elusive still. They are liable to infest almost any apparatus worked by valves, and have even been found on ordinary filament lamps.

The mere existence of amplification combined with feedback does not inevitably cause oscillation, of course; otherwise negative feedback for amplifiers would hardly be as highly esteemed as it is. The conditions for oscillation must be fulfilled. These are short and simple: oscillation will occur at any and every frequency at which the phase shift and the gain round the loop are zero. To see what

other (perhaps very remote) frequencies. Hence the unexpectedness and general obscurity of parasitic oscillation.

In audio amplifiers with negative feedback, for example, one takes care to make the phase shift as far from zero as possible; namely, 180° , bearing in mind that 360° is as good (or bad) as zero. Voltage fed back with 180° phase shift, so far from encouraging oscillation, tends to suppress it. But however successful the designer may be in keeping the phase on or near 180° at frequencies inside the amplifier's working range, there are always plenty of frequencies outside. Every amplifier contains reactances (intentional or otherwise), and their phase-shifting effects are bound to assert themselves at some frequencies, usually the very low and very high. The more stages that are subject to feedback, the greater is the risk that the intended 180° will be reduced to the fatal 0 or increased to the equally fatal 360° at some frequency at which there is still some gain left in the amplifier. Then there will be oscillation, which by definition would be parasitic, though perhaps not the sort that is generally considered under that title. A parasite by any other name is just as nasty, however; and the "negative" feedback sort (being generally far outside the working frequency band) may be as baffling to the uninitiated as most of them.

We studied the cause of this sort, and how to nip it in its smallest bud, last month; but what about amplifiers with no intentional feedback? There are, of course, plenty of ways in which positive (zero-phase) feedback can occur unintentionally, and the greater the gain of the amplifier the greater the risk. If the voltage amplification is 10,000, then it is only necessary for 1/10,000 of the output to find its way back to the input to cause oscillation. Most of the precautions against this are well known—keeping input and output wiring, and especially transformers, far apart and/or carefully screened; using adequate decoupling filters; and so forth—but occasionally there are less obvious feedback paths. Using the chassis as a common "earth" may look all right by

the circuit diagram, but even its low resistance can couple the output of a high-gain amplifier to the input if it is common to both circuits.

All these cases of undesired oscillation in amplifiers are more often called *instability* than parasitic oscillation; and that subject is comparatively familiar. The term *parasitic* is usually associated with the obscurer forms of oscillation affecting individual valves or stages, which we shall now consider.

In an effort I once made to see how high a frequency of oscillation I could get out of a small high-slope triode, I finished up with the delightfully simple circuit

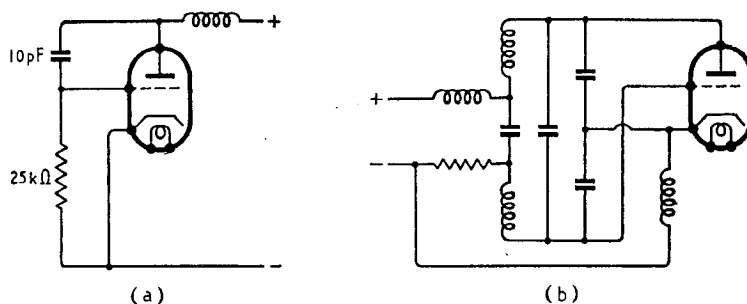

Fig. 2. (a) might be a fragment of almost any triode circuit, and is quite capable of oscillating at a high frequency. If the inductances of the leads and the stray capacitances are shown, it develops into (b).

shown in Fig. 2(a). The oscillatory inductance consisted, not, as might be supposed, of the one and only obvious coil (which was a r.f. choke), but of the short leads connecting the 10 pF to anode and grid. Drawing in the inductances of the leads and the interelectrode capacitances we have Fig. 2(b), which can now be recognized as a Colpitts oscillator circuit.

The point of this little story, if we bear in mind that the capacitance between wiring can soon add up to 10 pF, and that the inductance of the choke was not at all critical, is that Fig. 2(a) might easily be part of almost any apparatus containing a triode. But one would not necessarily be prepared for that apparatus to oscillate at 400 Mc/s.

In circuits where it is not intentional, feedback is most likely to occur via stray capacitance, and especially anode-to-grid capacitance. Such coupling becomes more and more effective as the fre-

quency is raised, which is the reason why parasitic oscillation is so often at a very high frequency. This tendency is partly off-set by the fact that the input impedance of a valve, across which any feedback voltage has to be established if it is to cause oscillation, goes down rather steeply at very high frequencies. Now the gain of a valve depends mainly on two factors—its mutual conductance, and the impedance of the coupling circuit. The higher the mutual conductance, therefore, the lower the impedance before the gain drops below zero. The impedance depends on frequency, so if a wider range of impedance is able to provide the critical gain, the

range of frequency at which oscillation can occur is widened, too. And the wider the range of possible frequencies, the greater the likelihood that at once or more of them (in addition to the desired frequency) the phase shift will be zero. So progress in valve design, resulting in higher mutual conductance, tends to increase the risk of parasitic oscillation. That is why we are hearing more about it than we used to.

The other thing to remember when looking out for parasites is that the circuit diagram shows only a part of the apparatus—as we saw with Fig. 2, it is generally the "invisible components" that cause the trouble. So when studying the circuit diagrams from this point of view, dot in the interelectrode capacitances and the inductances of the leads to the valves and see if they form possible oscillatory circuits.

Fig. 3(a), for example, looks like an ordinary a.f. output stage

Parasitic Oscillations—

with two triodes in parallel. There is no intentional or obvious unintentional feedback to cause oscillation, except possibly the anode-to-grid capacitance which, with stray capacitances across the transformers, might make the circuit into a tuned-anode, tuned-grid oscillator. But the natural frequency of the input transformer would almost certainly be in the audio band or thereabouts, so unless the anode-to-grid stray was unusually large it would hardly provide enough feedback.

But the actual wiring layout would probably be something like Fig. 3(b); and when the inductances of the grid and anode leads and the interelectrode capacitances are marked in (Fig. 3(c)) there is no difficulty in recognizing a push-pull v.h.f. oscillator. To have the stage oscillating violently at perhaps 300 Mc/s would be no help towards getting the best out of it as an a.f. amplifier, and the cause of the unsatisfactoriness might be quite hard to

stable, whereas another constructor's version might oscillate its head off. That is why the anti-parasitic devices prescribed by the designer could perhaps be dispensed with in some sets but not in all. Or why they might turn out to be necessary even though the designer didn't find them so.

If the grid and anode leads in Fig. 3(b) are shortened, their natural frequency is raised. The higher the frequency, the lower the input impedance of the valves, and the smaller the risk of the loop gain being sufficient for oscillation. So one anti-parasitic precaution is to keep the length of leads down, and especially to avoid parallel anode and grid leads. The best that can be done in this direction may not guarantee freedom from very-high-frequency parasites with high-slope valves, but a very effective policy is to lower the Q of any potentially oscillatory circuits by inserting series resistance. The best position for such resistance is at a current anti-node (i.e., place

press any oscillation, without upsetting the normal working. In receiving circuits, a fairly high value can usually be tolerated, but there is seldom any point in going above about 2,000 Ω . In transmitters where heavy grid current flows it may not be allowable to use more than a few ohms.

When valves are used in parallel—an arrangement particularly liable to parasites—it may be necessary to insert resistance in the other valve leads, too (anodes, screens, etc.), but, of course, the values are restricted. About 50 Ω is usual in the anodes of receiver-type valves.

Anti-parasitic grid resistors should not be confused with the considerably higher resistance "stoppers" that are sometimes employed to suppress oscillation in multi-stage amplifiers or to exclude r.f. currents from a.f. stages. They work on a different principle, using the input capacitance of the valve as the other element in a simple RC filter.

You may say that triodes in parallel, as in Fig. 3, are nowadays seldom favoured, for reasons quite apart from parasitic oscillations. But the popular push-pull arrangement is by no means immune; and one should be on guard, especially when using high-slope valves, and in triode transmitting circuits.

Owing to the relatively high powers involved, and the physical size of the circuits, transmitters present the worst parasite problems. In fact, it is taken almost for granted that they will occur in any new design of transmitter, and its delousing is part of the routine. As many as twelve different "modes" of oscillation have had to be suppressed in a single high-power transmitter.

Triodes are, of course, the most vulnerable, because they have to be neutralized, and that is fully effective only at the working frequency, leaving the door wide open at remote frequencies. At much higher frequencies, for example, the inductance of the leads throws it right out. Consider the neutralized push-pull

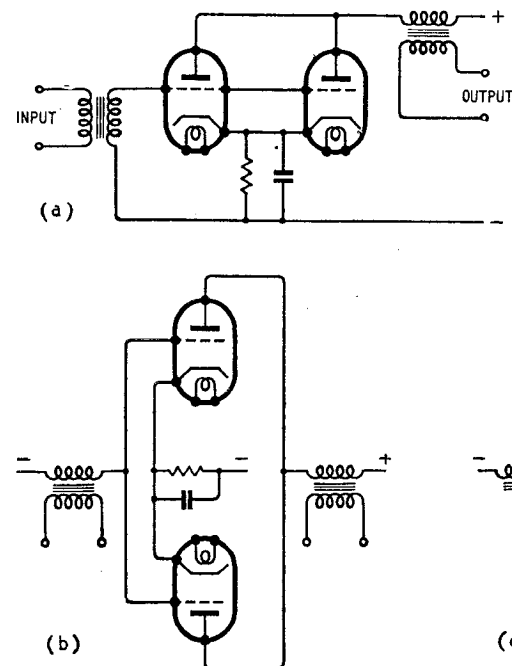

Fig. 3. An apparently harmless amplifier stage (a) with two valves in parallel as at (b), and if the strays are indicated it is revealed as a push-pull oscillator (c).

locate unless one was on the lookout for parasitic oscillation.

If should now be clear that the exact layout and dimensions of the wiring are often the decisive factors, so that a circuit wired up by one person might be perfectly

where the oscillatory current would be a maximum); but a more practical rule is to connect it as near the grid pin as possible, which generally comes more or less to the same thing. As for its value, it should be enough to sup-

stage in Fig. 4. At very high frequencies, the tuning capacitances, C_1, C_2, C'_1, C'_2 , are practically short-circuits, joining up the inductances constituted by the grid and anode leads and making a v.h.f. oscillator circuit very much as shown in Fig. 3 (b and c). Try redrawing the circuit on these lines and see. What the neutralizing capacitors will do depends on how much inductance their leads present, and whereabouts on the grid and anode leads they are connected.

Incidentally, it must be remembered that, owing to the inductance of quite short leads, it is possible for parts of the circuit that are supposed to be earthed to

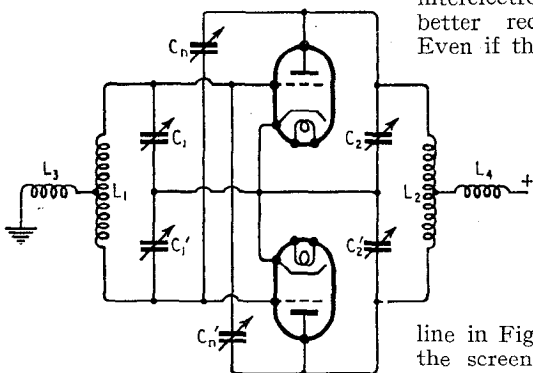

Fig. 4. This push-pull oscillator, if scrutinized on the same lines as Fig. 3, shows itself capable of oscillating at higher and lower frequencies than that intended.

attain quite high r.f. potentials. At a frequency much lower than the working frequency, L_1 and L_2 are practically short-circuits, and we are left with a tuned-grid, tuned-anode circuit in which L_3 and L_4 are the tuning coils and the two valves are effectively in parallel, with C_n and C_n' adding to the other feedback capacitance. This dire possibility is easily avoided, however, by suitably proportioning L_3 and L_4 . One of the favourite transmitter anti-parasitic precautions, in fact, is to put extra inductance in each anode circuit. This may seem to contradict the rule that anode-to-grid capacitance tends to cause oscillation when the anode circuit is inductive. The contradiction is only apparent, however, because if the natural frequency of the anode circuit is lowered (by means of inductance, say) below

the natural frequency of the grid circuit, then to oscillatory currents at the natural frequency of the grid circuit, the anode circuit appears capacitive, and oscillation is suppressed.

If that explanation only makes confusion worse confounded, don't worry about it, because several readers have already asked me to deal with this relationship of anode circuit to interelectrode feedback (Miller effect), and I hope to devote an article to it very soon.

People who, because they use tetrodes or pentodes instead of the old-fashioned triode, imagine themselves to be immune from the parasite-provoking effects of interelectrode capacitance, had better reconsider the matter. Even if they have taken care to exclude stray capacitances outside the valve (C_1 in Fig. 5), which might nullify the screening inside the valve, there is the question of inductance in the screen bypass circuit, marked in heavy line in Fig. 5. This may render the screening null and void at very high frequencies. It has even been known for the screen to act as an anode and oscillate with the grid.

Well, of course, one could go on indefinitely showing how various circuits might be capable of oscillating somewhere in the vast range of frequency, but I hope the general principles are clear enough by now to make this unnecessary. There are, however, one or two special types of oscillation that do not depend on feedback.

First there is the comparatively little-known Barkhausen type of oscillation, which I need not say much about because its unauthorized occurrence is confined mainly to high-power transmitters, and is of minor importance even there. It is a transit-time effect, generating centimetre-length waves when the grid is positive and the anode around zero potential.

Then there is the dynatron, depending on secondary emission, which in certain circumstances can cause what amounts to negative resistance, capable of neutralizing

the resistance of any tuned circuit and making it oscillate. An ordinary tetrode displays this

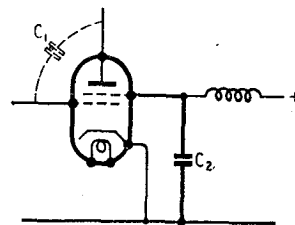

Fig. 5. Before a screened-grid stage can be assumed free from liability to oscillate through back-coupling, attention should be paid to external stray capacitance (C_1), and the inductance of the wiring drawn in heavy line.

effect when the screen grid is held at a higher voltage than the anode. Any reasonably low-loss circuit in series with the anode will then oscillate. Similar conditions sometimes arise in transmitters, whenever the grid runs positive at the peak of its swing and the anode is simultaneously at its least positive. Parasites generated in this way belong to the class that occur during only a portion of the working cycle, and are thereby much more difficult to trace because they usually disappear altogether when the signal is shut off.

A particularly obscure case of this kind was revealed some years ago.* It occurred in audio output stages, and caused an irritating "buzz" in the loudspeaker, but only when low notes were being reproduced. One would naturally tend to suspect filings or other impediments in the path of the loudspeaker cone; but the trouble was found to be due to the output valve. Finally the cause was traced to the metallic film deposited on the inside of the bulb during its evacuation. Sometimes there was leakage between it and the anode, which raised it to a high potential and enabled it to act as a secondary-emission electrode. At certain phases in each low-frequency cycle its potential would click over suddenly, giving rise to a disturbing transient.

A rather similar phenomenon in vacuum-type, metal-filament

* K. A. Macfadyen, *Wireless Engineer*, June, 1938, p. 310.

Parasitic Oscillations—

lamps was responsible for short-wave interference that was found to be coming from them. Although too thin to see easily, a semi-conducting film of evaporated tungsten does exist on the inside of the bulb in such lamps, and can act as a generator of

(perhaps worst of all) can cause highly expensive valves to die prematurely by overheating the seals or starting a flash-over.

Leaving out of account high-power transmitters, which are managed by persons who would hardly look to me for guidance, how can we detect parasites?

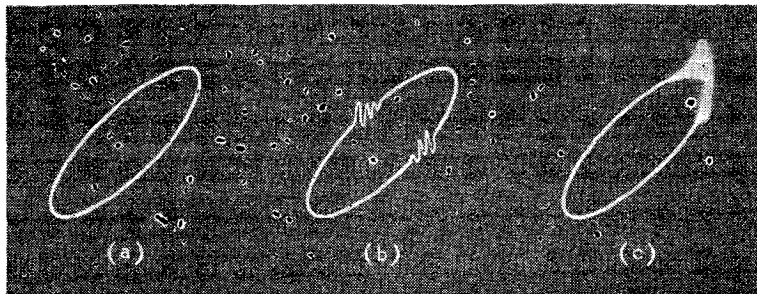

Fig. 6. At (a) is shown a typical signal trace on an oscilloscope when X and Y plates are connected respectively to input and output of an amplifier. (b) is an example of a transient parasite, and (c) a sustained oscillation; both occurring only at particular phases of the signal cycle.

parasitic oscillations. These oscillations are not of the continuous-wave type we have been considering, but are more like the interference discussed in the April issue, due to switching and other transients.

In this connection it must be remembered that even damped oscillations can be a nuisance. A parallel-feed choke in the anode circuit, for example, may be quite free from any circumstances tending to maintain it in continuous oscillation, but if normal working causes the anode current to be frequently and suddenly varied it may shock it into damped oscillation each time, perhaps at some frequency capable of causing interference.

And that raises the question of the harm that can be wrought by parasites. Interference, as we have just seen, is one possible nuisance. Distortion, rattles or buzzes, whistles, general noise, reduced output and efficiency, excessive anode current, leading to short life of valves, are some of the results in receivers and amplifiers. In transmitters, parasites are not only more likely to occur, but their effects are more serious. Besides causing interference, they can run away with a lot of the power that ought to be going into the proper frequency; they can modulate the carrier wave; and

The most usual clue, I find, is given by the anode current meter. Even if one is not fitted in the final circuit, it is (or should be) included in the experimental version. If the readings are not quite what they should be, and vary erratically—especially when moving things about near the

grid circuit, or touching it—then parasitic oscillation should be suspected. The corresponding audible symptoms may be an excessive noise level, and clicks as the circuits are touched or approached. In apparatus where the power to the valves is about 10 watts or more it may be possible to detect and locate parasites by moving a small neon-tube around.

The intermittent sorts that occur at particular phases of the signal cycle are more elusive, and a cathode-ray oscilloscope is almost indispensable. When a stationary picture of the signal is put on the screen, as in Fig. 6, this type of parasite can generally be seen as a "blip" or haze growing out of the normal trace. Before oscilloscope monitoring became part of the normal procedure when trying any new circuit, much perplexity and dissatisfaction was probably due to unsuspected parasites. Now, this sort of trouble can generally be seen quite clearly, and the effectiveness of remedies checked.

Summarizing these remedies, resistance close up to the grid (and perhaps other electrodes) is the most generally useful, in conjunction with an enlightened policy of laying out of the circuit.

REPRINTS OF ARTICLES

A LIST of articles which have appeared in *Wireless World* recently and of which reprints are now available is given below. The date of the original article is given in brackets. They are obtainable from our Publisher, Dorset House, Stamford Street, London, S.E.1. The price in parentheses includes postage.

Ex-Government Valves and C.R. Tubes. List giving valve type designations and their commercial equivalents (August, 1945), together with the characteristics of some ex-Service c.r. tubes (December, 1947). 6d (7½)

Ex-R.A.F. Communication Receiver. Modifications to the R1155 for civilian use (July, 1946). 6d (7½d)

Quality Superheterodyne. Design for a nine-valve receiver. By S. A. Knight (December, 1947). 6d (7½d)

Television Receiver Construction. Details for building a straight vision receiver and a sound channel (up to the detector), sync separator, line and frame time-bases and power supply unit (January-December, 1947). 2s 6d (2s 9d)

General-Purpose Oscilloscope. Modifications for converting an ex-Government radar unit such as the Admiralty Type 6A or 6B and the R.A.F. Type 10QB/24. By J. F. O. Vaughan (May, 1948). 9d (10½d)

Copenhagen Frequency Allocations. Complete list of European medium- and long-wave stations showing the frequencies allotted in the Copenhagen Plan which comes into operation on March 15th, 1950 (November, 1948). 6d (7½d)

Cathode-Ray Oscilloscope. Design for a general-purpose instrument with a three-valve time base, single-valve amplifier and two-valve wobblulator. By S. A. Knight (December, 1948). 6d (7½d)

Television Superheterodyne Unit. Constructional details for a long-range receiver for reception of Alexandra Palace transmissions (February and March, 1949), with a map showing the service area of A.P. (February, 1949). 2s 6d (2s 8d)

Midget A.C. Mains Receiver. Details of a two-valve medium-wave portable. By S. W. Amos. (March, 1949). 6d (7½d)

High-Quality Audio Amplifiers. A composite reprint of the following articles: "Wireless World A.C./D.C. Quality Amplifier"—two-valve circuit giving 2 watts from the output pentode (December, 1945); "W.W. Quality Amplifier"—circuit details for 4-, 8- and 12-watt designs (January, 1946); "Push-Pull Phase Splitter"—high-gain amplifier circuit, by E. Jeffery (August, 1947); "High-Quality Amplifier Design"—unit with push-pull tetrodes in the output stage, by P. J. Baxandall (January, 1948); "Economical 50-watt Amplifier"—circuit with KT66 output valves in push-pull, by G. R. Woodville (December, 1948). 2s 6d (2s 8d)

BRIMARIZE and guarantee your repairs

-SAFEGUARD WITH BRIMISTORS

ALL AC/DC receivers are improved by fitting Brimistors. Leading manufacturers are fitting Brimistors as a safeguard against failure during the critical warm-up period. Every set leaving your service department needs the same protection. See that all sets sold on hire purchase are fitted with Brimistors. The modest outlay will pay dividends in reduced service costs under guarantee.

PUNCH HOLES HERE

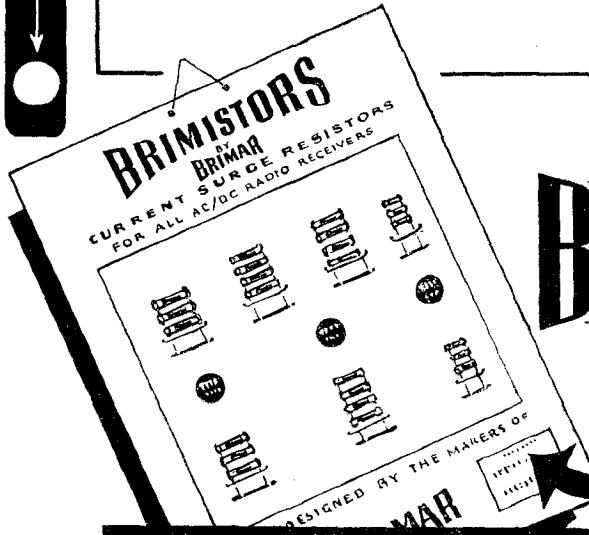
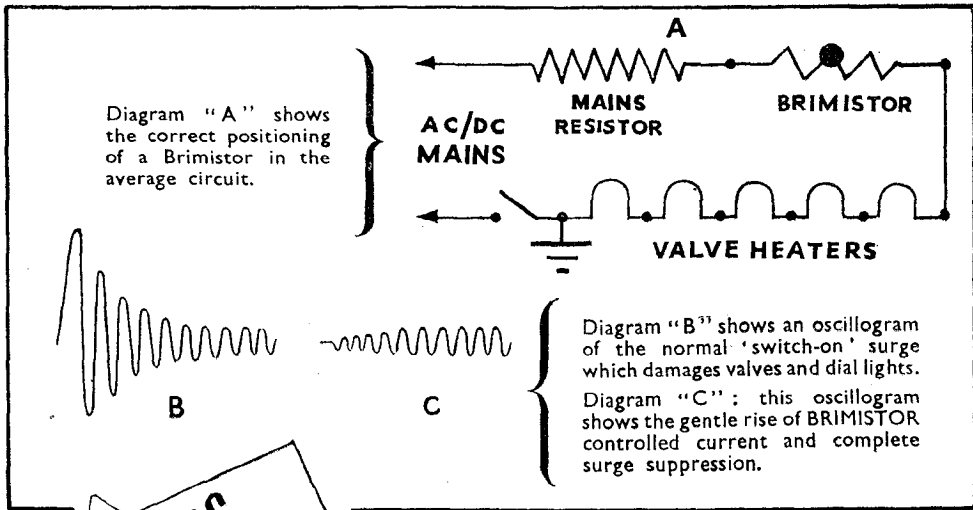

CURRENT SURGE BRIMISTOR RESISTORS

IN ASSORTED LOTS OF 24 FROM RECOGNISED WHOLESALERS

STANDARD TELEPHONES AND CABLES LIMITED, FOOTSCRAY, SIDCUP, KENT.

Why we designed the

STEREOPHONIC AMPLIFIER

In our search for really high quality we had already built an amplifier of .01 per cent. distortion and 40 times damping factor, which we believe is the finest straight amplifier in the world. Unfortunately we have been unable to obtain a single speaker which will faithfully reproduce the whole range, and when used to drive twin speakers via a cross-over network these introduced more distortion and peaks than could be tolerated. From this we drew the following conclusions.

The attainment of really high quality had always been marred by defects at the speaker end of the reproducer which were :—

- (a) The inability to cover the whole audio range with handling capacity of 8 to 10 watts at the lowest piano frequency of 26 cycles.
- (b) The interference caused by the Doppler effect, or where this has been minimised, the lack of speech coil feedback and damping at frequencies where that particular speaker should be silent.
- (c) The variation in acoustic power at the ends of the audio band, or the difference in efficiency of the two speakers when fed by cross-overs after the amplifier.
- (d) The resonance of the choke and condenser network at various frequencies which in one case gave a variation of 5 ohms to 105 ohms for a nominal 15 ohms impedence.

All these points were considered, and an amplifier was then designed and built to overcome all those deficiencies, the audible results exceeded expectations and a stereophonic effect was noticed on some records and the amplifier accordingly called "Stereophonic."

The requirements of triode cathode follower and 8 to 10 watts output is best met by PX4's, since their mains consumption is low compared to pentodes strapped as triodes and heater hum does not bother a cathode follower. A single valve is capable of the equivalent acoustic requirements at the higher frequencies. The cross-over is fitted in the middle of the amplifier where it is not concerned with power transfer and does not introduce resonance or distortion.

Superlatives fail in the description of the quality of reproduction from this new amplifier, but may we just say it gives the finest quality reproduction of any unit, some costing almost a thousand pounds, that we and many others have heard. This is due to the lack of resonances from the loud speakers, with the result that needle scratch is barely audible, even with the full audible frequency range.

Unlike most reproducers where bass is reduced to ensure good unmodulated treble it is possible in this case to retain the full richness of the bass without interfering in any way with the treble response, and the lowest organ note to the highest strings can be reproduced at the same time without modulation distortion. This high quality is maintained even at whisper strength to an abnormal degree.

In these few words we cannot convey just how good this quality of reproduction really is, but we do invite you to a demonstration, and if possible bring your own well-known test records, upon which to base your judgment

Chassis complete with valves

Price 36½ gns.

VORTEXION LIMITED, 257-261 THE BROADWAY, WIMBLEDON, LONDON, S.W.19
Telephones LIB 2814 and 6242-3

Telegrams "Vortexion, Wimble, London"

CONTRAST EXPANSION

A Review and Some Further Notes

By L. J. WHEELER

IN the manufacture of commercial gramophone records, limits are imposed on the range of contrast between the loudest and quietest passages. These limits are mainly physical in nature and are related to the combined necessities for maintaining a satisfactory signal/noise ratio and retaining adequate playing time at the standard speed of 78 r.p.m. with the existing groove size. A similar restriction, of course, applies in the case of radio transmissions, but the useful contrast range is greater and the upper limit is produced by the necessity for avoiding over-modulation of the r.f. carrier.

The greatest contrast between minimum and maximum volume of a full symphony orchestra is of the order of 70 db, and if such a range were used in cutting a record, and maximum cutting stylus velocity (corresponding to maximum amplitude of the signal being recorded) were set to the limit after which break-through of the groove walls occurs, then the amplitude of the quietest cut would be nearly comparable with the physical particle size in the finished pressing, with consequent very low signal/noise ratio. Alternatively, if minimum amplitude is to give a satisfactory signal/noise ratio, then maximum amplitude will cause break-through of the groove walls. In practice the upper limit is generally restricted manually by an engineer who, with the aid of a copy of the score, does his best to anticipate the advent of any crescendos and reduces the gain of the recording amplifier accordingly, the resultant contrast range being of the order of 45 db. Thus an expansion of 25 db is necessary for complete correction, although as far as one's neighbours are concerned this figure is apt to have too high an annoyance factor, and from 12 to 15 db is preferable. Accurate restoration of the original contrast

is virtually impossible by automatic means unless a monitoring signal accompanies the required intelligence; or until such time as the compression is introduced automatically to some well-defined and published law. The author would like to stress the fact here that the foregoing does not apply to *all* recordings or transmissions, as compression is unnecessary if the greatest range of contrast is within the powers of the transmission medium, as is the case of the solo violin, solo piano and similar items. In fact a contrast

ged in a bridge circuit, across the secondary winding of the output transformer. Whilst effective to a small degree, these circuits offer little or no control over the amount of expansion available, or any of its characteristics, and the expander itself consumes a fair amount of the audio power available for driving the loud-speaker. Although lamps have been suggested in feedback circuits, the power demands remain the same, and there is the invariable delay due to the thermal inertia of the lamp filament. The most satisfactory system is one that behaves as a voltage-operated device, and can con-

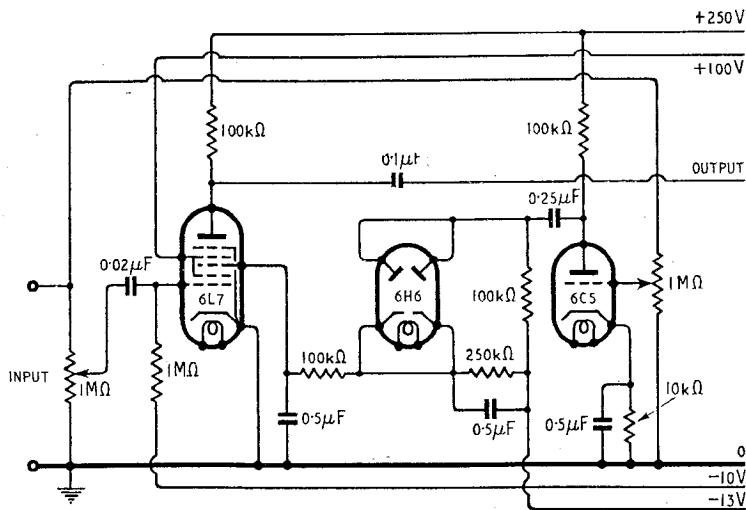

Fig. 1. Controllable-gain amplifier making use of a pentagrid valve.

expander carelessly used on such recordings can, and will, completely ruin the reproduction.

Although contrast expansion, as produced by the use of any of the following circuits, can, at best, be only a compromise, judicious employment of the advantages it has to offer will considerably enhance the reproduction of quite a number of recordings and radio transmissions.

The simplest type of contrast expander is that which uses one or more lamps, shunted or arran-

sequently be included in the signal chain without drawing power from it. Numerous such systems employing valves have been developed in the past, and it is the author's intention to review them briefly, discussing their respective merits as experienced in practice, and to describe a unit which has enabled considerably greater satisfaction to be obtained from the reproduction of gramophone records.

Modern contrast expanders consist of two parts, a controllable-

Contrast Expansion—
gain amplifier, which must under all conditions introduce the absolute minimum of hum or distortion, and a means for obtaining a voltage proportional to the

other than that which handles the signal. A typical example, shown in Fig. 1 (reproduced from "The Radio Designer's Handbook" by F. Langford Smith), operates on the principle that

duces a new component into the output waveform which is due to the change in anode current of the 6L7 with changing bias from the 6H6. This can be a very disturbing factor if the amplifier which follows the expander has a particularly good bass response. Additionally, and this applies to numerous other expandors, the rectifier is a half-wave unit and further distortion can occur due to poor smoothing of the control voltage on g_3 of the 6L7, necessitated by the importance of maintaining a short time constant in the network between the 6H6 and the 6L7. It can best be judged how unpleasant this form of distortion is, when it is realised that it comprises a partially rectified version of the signal introduced into the output! In fact it is very much worse than the periodic fluctuation of the 6L7 anode current, which can be ameliorated by arranging for the amplifier to have a sharp cut-off below about $40\frac{1}{2}$ c/s.

A later circuit, by A. Nelson Butz, Jr. of the Pennsylvania State College, U.S.A. (*Electronics*, September, 1946), quite satisfactorily disposes of the distortion component due to the changing anode current of the controlled valve (in this case a pentode controlled from its suppressor grid) by applying the control voltage to the suppressor grid of a second dummy pentode, the anode

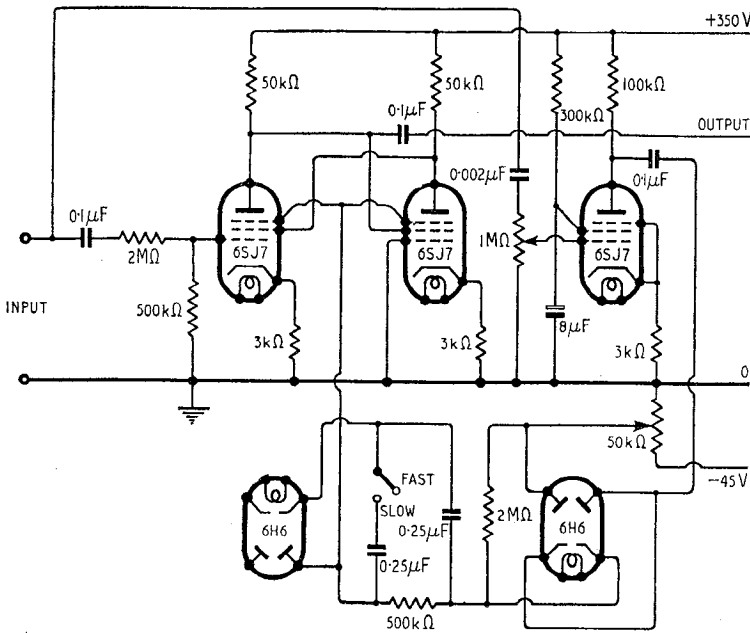

Fig. 2. Cross-connected pentodes are used in this circuit to remove distortion arising from changing anode current.

instantaneous value of the signal envelope, and with which the gain of the amplifier section may be controlled, together with the components for producing the necessary delay constants, control of the amount of expansion used and determination of the level at which expansion begins. It is an accepted fact that, for most realistic results, the time constant for the increase of gain shall be no greater than 20-25 milliseconds, although for the decline a time constant of up to 2-3 seconds is desirable, both to maintain the gain in staccato passages, and to improve the "liveliness" of the reproduction by not accentuating the decay of reverberation.

An obvious choice of circuit for the controllable-gain amplifier is, despite its disadvantages, one using a variable- μ valve, and most of the early expandors were designed around such valves as the 6L7, the gain of which can be controlled by an electrode

the gain of the 6L7 is a function of the bias applied to its control grid g_3 . This d.c. bias is proportional to the amplitude of the signal and is obtained from it by the 6H6 rectifier. In order to obtain a sufficient voltage to produce the required change in g_m of the 6L7, and to prevent the diode imposing a load on the signal source, a separate amplifier (6C5) is provided for the 6H6; the amount of expansion being controlled by the potentiometer in the grid circuit of the 6C5. The time constant for the increase of the gain is 50 milliseconds, and for the decline nearly four times that amount; no control of the point at which expansion commences is provided.

This circuit, whilst quite successful, has a few disadvantages, not the least important of which is the necessity for supplying two values of negative bias which must not vary with changes in the anode current of the expander valve. The expander itself intro-

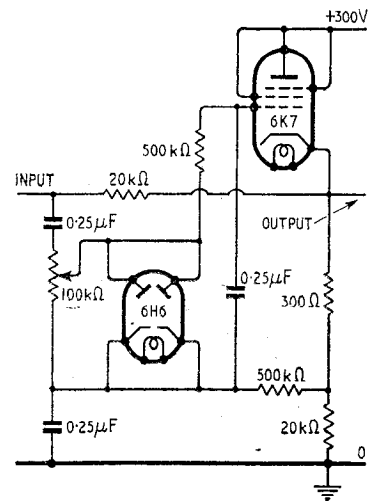

Fig. 3. Cathode-follower contrast expander.

and screen of which are cross-connected to the corresponding electrodes of the signal amplifier.

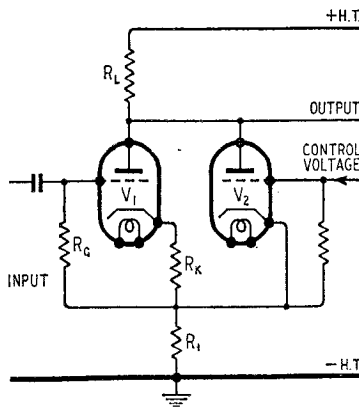

Fig. 4. Contrast expansion by negative feedback. V_2 and R_1 constitute the control potential divider.

If the bias on g_3 of a pentode is varied the change in anode current is opposite to the change in screen current; hence, by cross-connecting the screens and anodes of two pentodes the net change in the anode current of whichever is the signal amplifier can be reduced to zero, or negligible proportions, by an equal and opposite change in the screen current of the dummy valve, assuming the appropriate circuit constants and correct choice of valves. The author's experiments with this circuit, shown in Fig. 2, have proved the claims with regard to the removal of the fluctuating d.c. component from the output, and, due to the low g_3 - a mutual conductance of the 6SJ7, the failings of the half-wave rectifier are nothing like so apparent. The amount of expansion available, however, has been found to be somewhat restricted, and a steady supply of -45 volts has to be produced either from the h.t. or from a separate source.

Another very satisfactory method of removing the pulsing component due to the changing anode current of the controlled valve is to use two such valves in push-pull. If their signal grids are fed out of phase and the expansion

control grids in phase, the fluctuating anode current is in the same direction for both valves and is consequently cancelled out in the expander output transformer. The cost of the unit however, is increased by the cost of this transformer.

An oft-alleged disadvantage of contrast expanders is based on the fact that, owing to the difficulties attendant on electronically controlling the gain of high-level amplifiers with their large grid and anode voltage swings, the expander must be introduced at a low signal level with the consequent risk of hum and similar troubles. The majority of contrast expanders are designed to operate on an input of the order of 0.25 volts, but an interesting design (due to M. O. Felix, and previously published in *Wireless World*¹) is that shown in Fig. 3. It is extremely simple in operation, requires only two valves and functions with an input of the

¹ March, 1944

order of 20 volts. However, owing to the desirability of providing volume and tone control circuits in the early stages of amplifiers, use of this expander calls for major rearrangements of the circuit with which it is to be used.

It is probably not surprising that later developments of contrast expanders should revolve around circuits employing negative feedback. This panacea for almost all amplifier "ills" has long since ceased to be a plaything for the few and is now generally accepted as an essential and integral part of any equipment having any claims to high fidelity or consistency of operation. The next logical step was to apply its abilities to what, for want of a better name, we can call "unusual" circuits, i.e., really flexible tone controls, specialised circuits for measuring equipment, and the like.

The methods of using negative feedback to effect contrast expansion have previously been

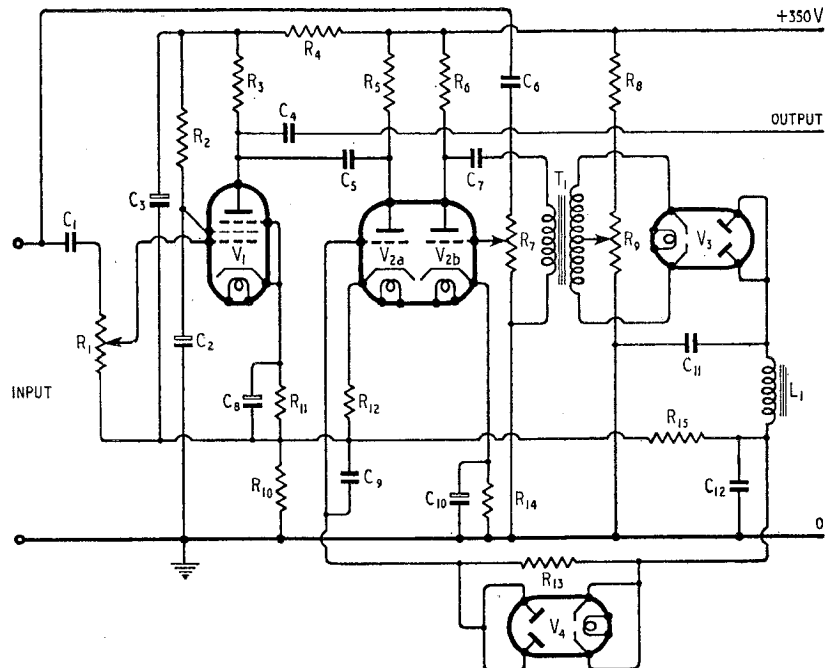

Fig. 5. Modified negative feedback control circuit used by the author. Components are as follows: R_1 , 1M Ω ; R_2 , 330k Ω ; R_3 , 100k Ω ; R_4 , 22k Ω ; R_5 , 100k Ω ; R_6 , 56k Ω ; R_7 , 1M Ω ; R_8 , 270k Ω ; R_9 , 100k Ω ; R_{10} , 220 Ω ; R_{11} , 2.2k Ω ; R_{12} , 330 Ω ; R_{13} , 2M Ω ; R_{14} , 3.3k Ω ; R_{15} , 1M Ω ; C_1 , 0.1 μ F; C_2 , 8 μ F; C_3 , 8 μ F; C_4 , 0.1 μ F; C_5 , 0.1 μ F; C_6 , 0.1 μ F; C_7 , 0.25 μ F; C_8 , 50 μ F; C_9 , 1 μ F; C_{10} , 50 μ F; C_{11} , 0.05 μ F; C_{12} , 0.1 μ F; V_1 , EF37; V_{2a} , V_{2b} , ECC34; V_3 , V_4 , EB34; T_1 , 1:2 midget a.f.; L_1 , 40/60H midget.

Contrast Expansion—

discussed by J. G. White² and it will be sufficient here to outline the basis very briefly. Fundamentally, feedback is applied over an amplifier by means of a potentiometer in which the relation between the two sections can be varied by the application of the control voltage derived from the signal; thus varying the amount of feedback and hence the overall gain. Obviously this can be achieved by making one section of the potentiometer a valve and altering its impedance by variation of its grid potential. This is shown in simple form in Fig. 4, in which V_1 is the amplifier and negative feedback is obtained from the potentiometer formed by the anode-cathode impedance of V_2 and R_1 , the former being variable by a voltage applied to the control grid of V_2 . Negative current feedback, due to R_1 alone, also exists and reduces the amount of expansion obtainable, as well as materially increasing the effective input impedance of V_1 . As previously shown by J. G. White, this disadvantage can be offset by returning the "earthy" end of V_1 anode decoupling capacitor to the junction of R_1 , R_k and R_g .

² *Wireless World*, Sept. and Oct. 1946

provided that the decoupling resistor is large compared with R_1 .

In the author's circuit, shown in Fig. 5, a pentode is used for V_1 as a greater ratio between the gains with and without feedback is obtainable with this type of valve, due to its initially higher amplification capabilities. It has been found experimentally that a small degree of cathode bias is necessary for V_2 ; the omission of this bias causes the grid circuit of the V_2 to impose a load on the rectifier system until the output of the latter is sufficient to prevent the flow of grid current in V_2 , with the result that the amount of expansion is small up to a certain level and then increases rapidly, giving rise to an unpleasant "snatching" effect. The value of this bias resistor also determines the maximum amount of expansion for a given input to V_{2b} , a higher value reducing the expansion.

The rectifier for supplying the control voltage is a straightforward full-wave circuit, with the exception that, as a negative voltage is required, the double-diode is reversed; the only component at all unusual in this application being the 40/60-henry choke in the "smoothing" circuit. This can be of the miniature hearing-

aid output variety designed to maintain its specified inductance at 0.2 mA, d.c. Whilst the presence of this inductance in the charging circuit of the 1 μ F condenser in the grid circuit of V_{2a} does tend to increase slightly the time taken for the gain to increase, its greatly increased efficiency in removing all traces of the expansion voltage from the output more than compensates for this.

The required difference in the time constants for the rise and fall of the gain is produced by the inclusion of V_4 and its parallel 2M Ω resistor in series with C_9 . When V_3 conducts, a negative voltage is produced at its anodes and applied to the grid of V_{2a} via V_4 which is also conducting and therefore of low enough resistance effectively to short-circuit R_{13} . The discharge path for C_9 is, of course, through R_{13} (V_4 now being non-conductive) and R_{15} . In practice the time constant for the increase in gain for a 5-millisecond transient is 18 k Ω \times 1.15 μ F or 20 milliseconds approximately, and whilst this does represent distortion of the transient it is in practice inaudible. For the decline the values are 3M Ω \times 1 μ F or 3 seconds.

The fact that the diode V_4 must, of necessity, be shunted by a 2M Ω resistor, leads to the conclusion that a metal rectifier could be substituted for these two components. Experiments along these lines have shown that a Westector type W2 forms an ideal substitute. Negligible change in characteristics resulted from this modification, and the Westector is considerably less expensive than the 6H6, valveholder and resistor. There is also a saving in heater current requirements.

From the foregoing the author was naturally led to try replacing V_3 with metal rectifiers, and Westectors type W4 proved satisfactory for this purpose, two such units, of course, being required.

The degree of expansion obtained depends on the setting of R_7 , and the level at which expansion commences is determined by the delay voltage applied to the cathodes of V_3 by the poten-

TABLE

Input, V_1 (Volts, r.m.s.)	Input, V_{2b} (Volts, r.m.s.)	Output, V_{2b} (Volts, r.m.s.)	Delay on V_3 (Volts)	Output, V_3 (Volts)	Anode current, V_{2a} (mA)	Output, V_1 (Volts, r.m.s.)	Gain, V_1 (db)
0.1	—	—	—	—	3.1	0.9	19.1
0.25	—	—	—	—	3.1	2.25	19.1
0.5	—	—	—	—	3.1	4.5	19.1
1.0	—	—	—	—	3.1	9.0	19.1
0.1	0.1	1.0	—	1.0	3.0	1.0	20
0.1	0.5	5.0	—	5.0	2.5	1.1	20.8
0.1	1.0	10.0	—	10.0	1.9	1.2	21.6
0.1	2.0	20.0	—	20.0	1.0	2.0	26
0.1	4.0	40.0	—	40.0	0.17	4.0	32
0.1	0.1	1.0	1.0	—	3.1	0.9	19.1
0.1	0.5	5.0	1.0	4.0	2.6	1.05	20.4
0.1	0.5	5.0	5.0	—	3.1	0.9	19.1
0.1	1.0	10.0	5.0	5.0	2.5	1.1	20.8
0.1	1.0	10.0	10.0	—	3.1	0.9	19.1
0.25	2.5	25.0	10.0	15.0	1.5	4.0	24.1
0.5	5.0	50.0	10.0	40.0	0.17	20.0	32
1.0	10.0	100.0	10.0	90.0	0.05	48.0	33.6

tiometer R_9 in series with R_8 across the h.t. supply. The table shows the relationship between input and output voltages in the expander for varying values of input delay voltage, and the relative settings of R_1 and R_7 .

HIGH-FLUX LOUDSPEAKER

Details of the Goodmans "Axiom 22"

THE trend towards the use of higher flux densities in loudspeakers designed for high-quality reproduction is well exemplified by the new Axiom 22 made by Goodmans Industries, Lancelot Road, Wembley. So far as the diaphragm is concerned, it is the same as the Axiom 12 and has twin curved-sided cones with a reinforced edge to the high-frequency cone. The back centring device consists of a porous bakelized linen diaphragm with concentric corrugations.

The ring type magnet makes use of one of the new high-performance alloys, and by careful design of the poles the flux density has been raised to 17,500 gauss. This is in a gap 1.15mm wide, 7.8mm deep, with a nominal pole diameter of 44mm.

We have had an opportunity of hearing the Axiom 22 with an

Axiom 12 as reference standard, and there can be no doubt of the improvement conferred by the in-

crease in "presence" and the segregation of the instruments of the orchestra. The Axiom 12 is a very good loudspeaker, but the "22" is quite definitely better. The price is £12 13s.

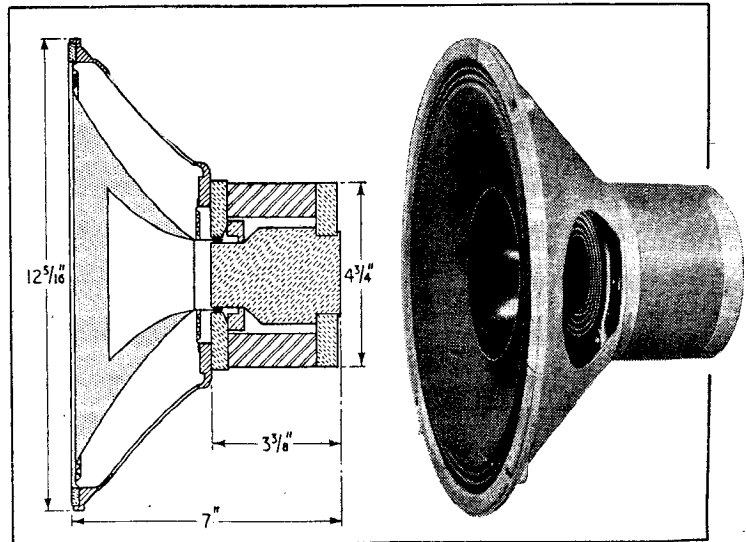

Goodmans "Axiom 22" loudspeaker. The sectional drawing shows the general arrangement of the ring magnet and polepieces.

creased flux density. Sensitivity is of course higher, but the outstanding impression is one of tautness and the grip the Axiom 22 has on transients. The increased magnetic damping is no doubt also respon-

provement in "presence" and the segregation of the instruments of the orchestra. The Axiom 12 is a very good loudspeaker, but the "22" is quite definitely better. The price is £12 13s.

1949 A.R.R.L. HANDBOOK

THIS is the twenty-sixth edition of the Radio Amateur's Handbook, issued by the American Radio Relay League, West Hartford, Connecticut, U.S.A. It is written for radio amateurs and covers a very wide field, with a nice balance between transmission and reception techniques. Its 605 pages of technical matter includes 1,651 illustrations, charts and tables, and they are divided into 25 chapters each

dealing with a specific subject. For example, chapter 5 is h.f. receivers, chapter 13 is v.h.f. transmitters, and chapter 19 deals with the elimination of interference with broadcast.

Most of the chapters have been revised with new material and equipment replacing some of the old. This is particularly the case in the v.h.f., microwave and aerial equipment chapters. Finally, a word must be said about the very comprehensive valve data, no fewer than 52 pages being devoted to this.

The handbook is obtainable in this country from, among others, A. F. Bird, 66 Chandos Place, London, W.C.2, the price being 15/6 (16/3 by post), or it can be ordered through The Radio Society of Great Britain, New Ruskin House, Little Russell Street, London, W.C.2, and the price, for delivery from America, is 12/6, including postage.

Smart, 110, Woolmore Road, Erdington, Birmingham, 23, Warwicks.

Catterick.—Meetings of the Catterick Amateur Radio Club (G3CIO) are now held on Wednesdays at 7.30 in Catterick Camp. Sec.: G. R. Styring, c/o 2 Squadron, I.T.T.K., Royal Signals, Catterick Camp, Yorks.

Derby.—New headquarters are being sought by the Derby and District Amateur Radio Society which at present meets on alternate Wednesdays at 7.30 at 119, Green Lane, Derby. Sec.: F. C. Ward, G2CVV, 5, Uplands Avenue, Littleover, Derby.

Exeter.—Meetings of the Exeter and District Radio Society are now held in the club's new headquarters at 9, Palace Gate, Exeter, on Thursdays at 7.30. Sec.: E. G. Wheatcroft, 34, Lethbridge Road, St. Loyes, Exeter, Devon.

Reading.—An instructional section of the Reading Radio Society has been formed for newcomers to amateur radio. Club meetings are held on the second and fourth Saturday of each month at 6.30 at Palmer Hall, West Street, Reading. Sec.: M. Hill, G2FZI, 997, Oxford Road, Reading, Berks.

Southend.—In preparation for a d.f. contest between the Romford and Southend radio societies, members of the latter are taking part in a walking d.f. practice at Belfairs on July 17th. Sec.: J. H. Barrance, M.B.E. (G3BUJ), 49, Swanage Road, Southend-on-Sea, Essex.

SMALL MAINS RECEIVER



Operating from a.c. or d.c. mains this new Model 47X four-valve receiver by Pye, Cambridge, measures 13 1/2 in x 6 1/2 in x 5 1/2 in and costs £11 9s. 5d. including tax.

NEWS FROM THE CLUBS

Birmingham.—The meeting of the Slade Radio Society on June 10th will be addressed by Dr. W. Summer on the subject of electro-medical instruments. Meetings are held on alternate Fridays at 8.0 at the Parochial Hall, Slade Road, Erdington. Sec.: C. N.

"Q"-METER CONTROVERSY

What Are We Trying to Measure?

IT is curious that although the "Q" Meter has been well known and used by radio engineers for some years, the article by H. G. M. Spratt in the January 1949 *Wireless World* was, to my knowledge, the first account of this nature to be published in any English-speaking technical journal.

My chief purpose is to raise a question of nomenclature, but in order to make the case it will be necessary to try to clear up certain prevalent misconceptions, not only about the functioning of the instrument, but also as to the meanings of the terms "Q" and circuit magnification. A second purpose is to present (in the appendix below) some theoretical considerations which may also serve to clear the mind as to the way the instrument functions.

The proposals will be stated first, so that the proposed terms can be used in what follows.

(a) "Q" is one of the most inelegant terms yet thrust into the English language on the other side of the Atlantic. The alternative suggested is Q-factor which, although only half-way to perfection, at least has some degree of acceptance already, since it appears in the British Standards Institution Glossary. The proper place for "Q" is, of course, in algebraic equations.

(b) The instrument should be called a circuit magnification meter, because it works by measuring the magnification of a circuit of which the impedance being measured forms a part. Again, a strong precedent for this exists, as the British firm which introduced the instrument to this country so called it, and still does.

Q-factor.—This is a property possessed by every two-terminal network, and its value varies with frequency. It is correctly defined by Mr. Spratt in the first paragraph of his "Fundamental Considerations" as the ratio of energy stored to energy dissipated in the network. With the remainder of this paragraph the writer does not wholly agree, as

there seems to be some confusion between Q-factor and circuit magnification. The writer's view is as follows.

An equally valid, and perhaps more useful, definition of Q-factor is the tangent of the phase angle (ϕ) of the network; i.e., the angle between the applied voltage and the resultant current, reckoned positive when voltage leads current. Thus $Q = \tan \phi$, and Q and ϕ are real and of the same sign. In the special case of a network which consists of a pure resistance (R) and a pure reactance (X), it is then easily seen that, when these are in series, $Q = X/R$. If however the components are in parallel, $Q = R/X$. Thus the statement that Q-factor is reactance/resistance needs some qualification.

Mr. Spratt later states, not without precedent, "the effective Q . . . whose value differs slightly from that of the real Q." Now the Q-factor of a coil, or any other

limits of frequency, are stated. At low frequencies the Q-factor of a coil will be proportional to frequency ($\omega L/R$) but as the frequency is raised it rises less steeply, and flattens out to a broad maximum in the region of half the frequency at which the coil is self-resonant. At the self-resonant frequency, $Q = 0$, and at still higher frequencies it becomes negative, the reactance of the coil then being capacitive. It is thus nonsense to assign any one value for the Q-factor of a coil.

Circuit Magnification.—Circuit magnification (m) is a property possessed by every four-terminal network, and also varies with frequency. When it is less than unity it is called attenuation, but this is basically the same. It may be defined as the scalar ratio of the voltage output to the voltage input, at a given frequency. Thus in Fig. 1(a) $m = |V/e|$, and is always real and positive.

The particular case with which we are constantly concerned in circuit magnification meter

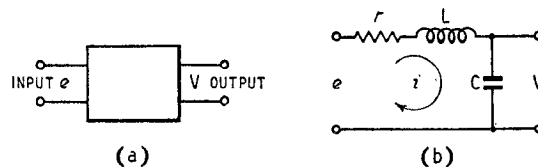

Fig. 1. Circuit magnification.

two-terminal impedance, at a given frequency, is as measured at its terminals. The same is true as to its reactance, impedance, or whatever other parameter we may find it convenient to use and measure. Nothing is more real than this. The writer has yet to find any practical, or even theoretical, use for the so-called "real Q" of a coil, and suggests that it is a misleading notion and best forgotten.

A common misstatement (from which Mr. Spratt is absolved), which is freely indulged in by an American "Q-meter" manufacturer, is that the Q-factor of a certain coil is so-and-so, or is approximately so. This is meaningless unless the frequency, or

measurements is shown in Fig. 1 (b). When the capacitor is varied slowly through resonance the voltage output will pass through a maximum value.

It is this maximum voltage, calibrated in terms of circuit magnification, which is, in fact, measured by the meter, and which we will denote by M. It is shown in the appendix below that the Q-factor of the coil is then correctly given by $Q = \sqrt{M^2 - 1}$, but that in practice $Q = M$ numerically within the limits of error of the instrument.

Thus within certain limitations a commercial instrument will give a direct reading of the Q-factor of a coil. If this were its only application, the term "Q-factor meter" might be defensible, but the instrument can handle a much wider field of measurement, as Mr. Spratt rightly shows. The writer fails to see why he should

"Q" Meter Controversy—

measure, say, the attenuation constant of a cable with a Q-factor meter, but can see clearly how this might be achieved with a circuit magnification meter.

P. H.

APPENDIX.

In Fig. 1(b), r and L are the equivalent series circuit, at the frequency of measurement, of a coil whose Q-factor is being measured. For a small change of frequency, as when tuning through resonance, it may be assumed that these values are constant.

Now

$$i = \frac{e}{r + j(\omega L - 1/\omega C)}$$

and

$$V = \frac{i}{j\omega C} = \frac{e}{j\omega C[r + j(\omega L - 1/\omega C)]}$$

$$\frac{e}{V} = j\omega Cr - \omega^2 LC + 1$$

$$\left| \frac{e}{V} \right|^2 = \frac{1}{m^2} = (1 - \omega^2 LC)^2 + \omega^2 C^2 r^2 \dots \dots (1)$$

Differentiating this with C as the independent variable, and equating to zero, we obtain,

$$2\omega^2(r^2C - L + \omega^2L^2C) = 0 \quad (2)$$

Inspection shows that the function here is a minimum; i.e., m is a maximum (M). Physically this represents tuning the capacitor to obtain a maximum voltage output. From (2) the conditions at resonance are

$$C = \frac{L}{r^2 + \omega^2 L^2} \quad \dots \quad (3)$$

and

$$\omega^2 = \frac{1}{LC} (1 - r^2C/L) \dots$$

$$= \frac{1}{LC} (1 - 1/Q^2) \dots \dots (4)$$

where Q is the Q-factor of the coil.

Substitute the value of C in (3) in equation (1) and we obtain,

$$M = \sqrt{Q^2 + 1} \quad (M \text{ being always positive}) \quad \dots \quad (5)$$

and

$$Q = \sqrt{M^2 - 1}$$

Here again, only the positive value is possible since the series arm of the circuit must be inductive for a resonance to occur.

In some circuit magnification meter measurements the oscillator is tuned for resonance, the capacitor remaining fixed. It is therefore of interest to find what happens if we differentiate equation (1) with ω as the independent variable. This leads to the curious results,

$$\omega^2 = \frac{1}{LC} \left(1 - \frac{1}{2Q^2} \right) \quad \dots \quad (6)$$

and

$$M = \frac{2Q^2 + 1}{\sqrt{4Q^2 + 1}} \quad \dots \quad (7)$$

It remains to try L as the in-

dependent variable. Though not usual in practice, this is quite possible physically. This gives results,

$$\omega^2 = 1/LC \quad \dots \quad (8)$$

and

$$M = Q \quad \dots \quad (9)$$

In practice no commercial instrument reads a circuit magnification less than 10, and it may be seen in this case that equations (4) and (6) approximate to (8), and (5) and (7) to (9), with an error not exceeding 1 per cent, and certainly inside the limits of error of the instrument.

THE AUTHOR'S REPLY

WHILST agreeing with P.H.'s comments to a large extent, I feel they cannot be accepted *in toto*.

Regarding nomenclature I agree that neither "Q" nor Q-Factor Meter is an elegant name for the instrument but both these terms have now been sanctified by usage and the inclusion of one of them in the B.S.I. Glossary would seem to settle the matter. On the other hand, I am by no means convinced that Circuit Magnification Meter would be wholly acceptable. P.H. upholds this title on the grounds that the instrument "works by measuring the magnification of a circuit of which the impedance being measured forms a part," the circuit referred to being, of course, that of the instrument. If, however, the impedance being measured is a coil and we transfer it to another circuit, the *circuit* magnification will almost certainly be different. Hence the use of this title could be condemned as misleading and we must resign ourselves to the absence of a term defining the instrument accurately, comprehensively and elegantly.

The suggestion that Q-factor can be defined as the tangent of the phase angle of the network must again, I think, be accepted with some reserve for, taking this proposal to its logical conclusion, as the writer has done, we find ourselves faced with a negative Q in the case of capacitive reactances. I cannot recall any reference ever to a negative Q and indeed such a possibility would appear to violate the fundamental conception of Q as the ratio $\frac{\text{Energy stored}}{\text{Energy dissipated}}$. It could not be applied to any

passive network but might, analogous to a negative conductance, be applicable to a circuit containing an energy source.

I agree that the determination of the real Q in addition to the effective Q is seldom important. It should be borne in mind, however, that the instrument is expected to measure effective and real inductance as well as Q and the two real values go hand in hand. The usefulness of the knowledge of the real Q is certainly limited if it is proposed to derive from it the value of Q over a wide frequency range. Apart from P.H.'s observations regarding the variation of Q-factor with frequency, there is the change in effective resistance which inevitably occurs at the same time and makes accurate prediction impossible.

I particularly appreciate the analysis included in the appendix. It certainly fills one of the more obvious gaps in the original article.

H. G. M. S.

"Q"-METER ELEGANCIES

Dr. V. A. Sheridan, of British Physical Laboratories, makes these comments on the original article.

I WAS rather surprised that the article on "Q" meters describes in detail a very old type of circuit. It is well known that this arrangement has the disadvantage of using a 0.04-ohm resistance as a "standard." It is extremely difficult, if not impossible, to produce a resistor of this type without an appreciable series reactance, which, naturally, produces large errors at the higher frequencies.

The more elegant approach to

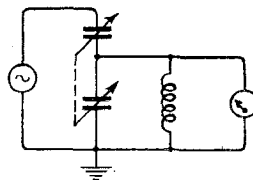

Fig. 2. Injecting r.f. through a ganged feeder capacitor.

the design of Q meters would obviously be to avoid the use of the series resistance. A number of years ago my firm introduced a method, which has since been (Concluded at foot of page 218)

DISTORTION IN F.M.

Selective Delay of the Signal in Tuned Circuits

By THOMAS RODDAM

THE Fat Boy in "Pickwick Papers" has always been a favourite character of mine. He would, I am sure, delight in Fig. 1, which shows the effect of passing a f.m. signal through an amplifier having a tuned circuit in one anode: the i.f. amplifier of the receiver you are building. This is the effect on the audio frequency, not on the carrier,

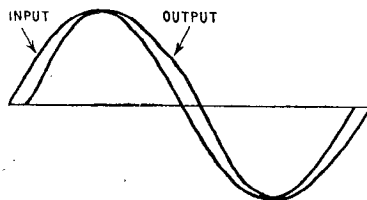

Fig. 1. Effect of tuned circuit on f.m. signal.

and represents quite a lot of distortion. In this article I shall try to explain where this distortion comes from, and how to keep it within bounds: I say try, because the only discussions of this problem which have been published make use of long mathematical analyses which the Editor would consider to be beyond the scope of this journal.

It is usually assumed that f.m. does not involve any distortion problems, except in the discriminator and audio-frequency amplifier. After all, thinks the unwary student, nothing could be more non-linear than the limiter stage, and that is supposed to be a Good

Thing. He probably reads the descriptions of transmitters, too, with their Class "C" amplifiers and harmonic generators: once the stuff is frequency-modulated it never seems to go through a linear circuit again. All this is true, although there are some relatively small effects produced by amplitude distortion. Unfortunately there is quite a different source of distortion in an f.m. receiver, and it is not any easy thing to measure without a special set-up. The distortion in f.m. is produced in the inter-stage couplings of the intermediate-frequency amplifier.

In Fig. 2 there is a skeleton diagram of a typical i.f. amplifier stage for 4.3 Mc/s, or whatever you have chosen for your f.m. receiver. The pentode is assumed to act as a current generator, so that the voltage applied to the grid of the second valve is

$$g_m e_g (R + j\omega L) / (1 - \omega^2 LC + j\omega CR)$$

where g_m is the mutual conductance, e_g is the input to the am-

plifier grid, ω is the angular frequency $2\pi f$ and LCR is the anode load shown in the figure. I do not propose to start manipulating this

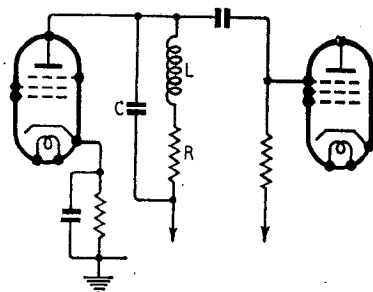

Fig. 2. Skeleton circuit of i.f. amplifier stage.

expression, because that is done in every textbook on circuit theory ever published. What it means, without the mathematics, is that the voltage at the second grid is displaced in phase from the voltage at the first grid by an amount depending on the frequency, in addition to the usual amplitude characteristics of the tuned circuit. This phase characteristic is shown in Fig. 3.

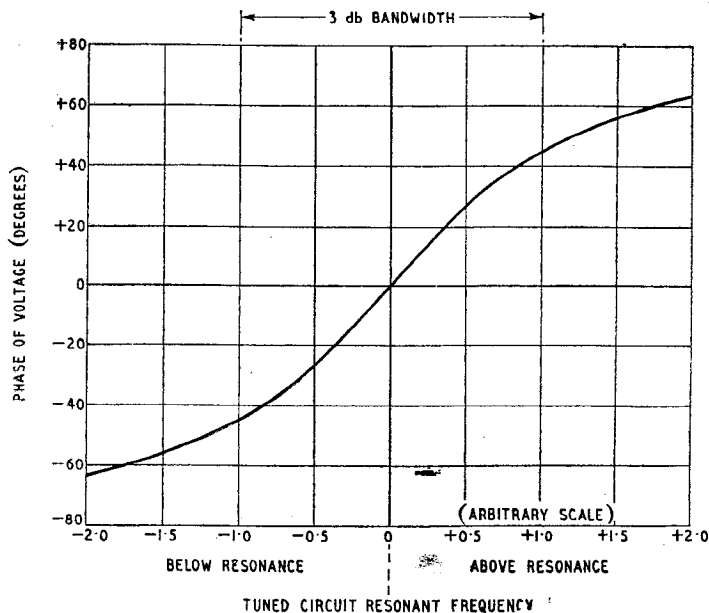

Fig. 3. Phase characteristic of tuned circuit.

"Q" Meter Elegancies—

[Concluded from page 217]

used in a number of other commercial Q meters, of injecting the r.f. into the tuned circuit. This is accomplished by means of a series-feeding capacitance, which is ganged with the tuning capacitor. This method, which is used in our instruments, also enables the values of inductance and self-capacitance to be measured directly. This particular method is shown in Fig. 2 (see preceding page).

When a signal passes through a network it does not appear at the output at the same instant as it was applied at the input. It is delayed by a time depending on the nature of the network. This is quite obvious if the network is, say, 100 miles of cable, but it is equally true for simple lumped networks, so long as you can find a definition for delay. The delay is equal to the slope of the phase characteristic: a low-pass filter with a 1,000 c/s cut-off has a slope of about π radians / 1,000 c/s for low frequencies, so that the delay for a 100 c/s wave, say, is $\pi/2\pi \times 1,000$ seconds, which equals $\frac{1}{2}$ millisecond. This sort of thing is used in some voice-operated devices, where, for example, 100 sections with a 5,000 c/s cut-off will be used to delay speech by 10 milliseconds in order to allow the switching operation to take

ahead. By using the delay curve of Fig. 4 the waveform shown in Fig. 1 can be plotted. The peaks of the modulation lead the zeros, so that the waveform is distorted as though it had been drawn on an elastic sheet held down in the middle and pulled sideways at the edges in the way shown in Fig. 5. If the circuit is not tuned to the centre frequency, but is off tune, the distortion will be worse, because one half of the wave will swing even further up the curved delay characteristic, and will thus be even more distorted.

Of course, Fig. 1 is greatly exaggerated, like the report of Mark Twain's death. By the time that the waveform had reached this amount of distortion a new trouble would have arisen: as the frequency varies, the amplitude also varies, due to the selectivity of the tuned circuit, and

If $Q = 10$, this is 0.16%, but if $Q = 30$ it becomes 4.3% for a modulating frequency of 10 kc/s.

Actually, this distortion is not entirely produced by the mechan-

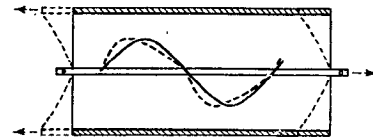

Fig. 5. Model using rubber sheet to show distortion due to phase shift.

ism described above, but by a "ringing" of the tuned circuit as the frequency passes through the resonant frequency of the circuit. There is, therefore, some production of very high harmonics, and a typical observed waveform is shown in Fig. 6.* I haven't discussed this effect because it is not easy to see what is happening: the equations are so-and-so, and the results are such, is the usual treatment.

The expression above is for the third harmonic. If the circuit is off tune, the second harmonic appears. This is

$800 Q^3 (\Delta f/f) (f_m/f) (\delta f/f) \%$
 where, in addition to the terms previously defined δf is the detuning.

The amount of second harmonic given by this expression is equal to the third harmonic given by the previous equation when $\delta f = \Delta f/4$, which means that the detuning is 18.75 kc/s. This means that the oscillator

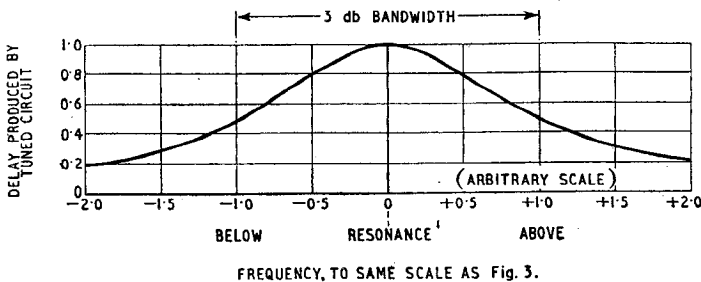

Fig. 4. Slope of phase characteristic.

place. The switching control circuits are connected to the delay network input, and the speech moves through the network while the switch at the far end is being operated. Radar and pulse modulation systems also use delay networks both for pulse formation and for delaying the pulses.

Looking at Fig. 3, it will be seen that the slope of the phase characteristic is not constant. In Fig. 4 I have shown how the delay varies for frequencies away from the resonant frequency of the network. It will be seen that the delay decreases as the frequency is shifted away from the resonant frequency in either direction.

What happens to a frequency-modulated signal when it encounters such a network? The centre frequency passes through slowly, but as the frequency is moved away from the centre frequency by the modulation the wave gets

even at the edges of the band, that is ± 75 kc/s away from the centre frequency, the limiter must be fully loaded. If the Q of the tuned circuit is too high, the extreme frequencies will be attenuated too much to drive the limiter and then, with some types of discriminator, you are in for trouble of a different kind.

The mathematicians do not approach the problem in this way. They write down the sidebands—that horrid array of Bessel functions—shift the phases and then add up all the sidebands again. If you do this, you find that the distortion is given by the following expression:

$$200 Q^3 (\Delta f/f)^2 (f_m/f) \%$$

where f is the centre frequency—4.3 Mc/s in the i.f. amplifier
 Δf the deviation—75 kc/s.
 f_m the modulating frequency.
 Q the "goodness" of the circuit.

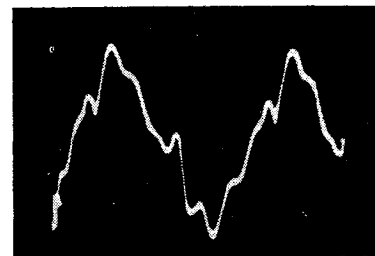

Fig. 6. Typical distortion produced by "ringing" in a circuit of narrow bandwidth.

must be stable to within 1 in 5,000 if the second harmonic is to be less than the third harmonic.

As soon as several stages of

* Based on Fig. 18 of an article "Tuned-circuit F.M. Distortion," by D. L. Jaffe, *Proc. I.R.E.*, Vol. 33, May, 1945.

Distortion in F.M.—

i.f. amplification are used the situation becomes very difficult. Tuned transformers can have very awkward phase characteristics, and as a general rule it can be said that it is better to under-couple than to over-couple. A very good phase characteristic can be obtained with a triple-hump circuit, using a very flat centre hump and two compensating ears, rather like a full face view of a terrier; but the design of such circuits is difficult, their construction impracticable for receiver work and the hope of keeping them in adjustment is quite non-existent.

So much for the Fat Boy: Mr. Boffin, you will remember, was a dustman; must you call in his services to take your junk away? I do not think so: in our Dickensian tour there is that other character, who always expected something to turn up. Let us see what we get for our circuits.

With a Q of 10, and a tuned circuit capacitance of 50pF we shall have a tuned circuit impedance of 50,000 ohms. This is more than we can safely use, anyway, if the i.f. amplifier is going to be stable. We can, therefore, design the amplifier round a Q of 10 and be fairly sure that the distortion will be kept below 1%. If we do this, there is really not much point in using staggered circuits, because they must be lined up much more carefully than ordinary single-tuned circuits if the response is to be symmetrical. Stray feedback is probably the greatest danger, as it can tip the response sideways in a most damaging way and thus produce an unsymmetrical phase characteristic, with the consequent production of second harmonic.

Double-tuned circuits, as one would expect, give more distortion than single-tuned circuits, because in general there is more phase shift, and thus more likelihood of the phase shift being non-linear. Double-tuned circuits are also liable to have more "bumpy" phase characteristics, which produce a lot of inter-modulation under suitable conditions. In addition, it is extremely difficult to keep them

symmetrical, and any deviation from symmetry destroys the second-harmonic balance. Another possible circuit, which I hope to describe later, is the negative feedback pair. This gives some squaring up of the ordinary tuned - circuit characteristic. Squaring up must not be carried too far, however. For amplitude modulation the ideal characteristic is the flat-topped "maximal flatness" characteristic, but for f.m. it is better to have the gentle droop which gives a good phase characteristic.

Another thing which must be watched very carefully is the effect of high signal levels. If the amplifier valves run into grid current the response can be seriously affected, and in comes the distortion. That is why the distinction between limiter and amplifier must be made quite definite. The limiter stage, or, if you are extravagant, stages,

can be very flat, so that no detuning is apparent, while the amplifier stages are carefully controlled to work under Class "A" conditions.

I have tried to describe the way in which f.m. receivers produce distortion in fairly simple terms: I have not tried to explain how the phase characteristic of the receiver can be measured. There are a number of methods available, but anyone who has the facilities for measurement of sufficient accuracy will probably also know where to find descriptions of the methods. So long as low- Q circuits are used and the amplitude response is made symmetrical, smooth and without humps, the main distortion will come from mistuning. This is a separate problem, and the only suggestion I have is the use of automatic tuning correction circuits. That means more valves, but that is the price of quality.

PIEZOELECTRIC CERAMICS

New Materials for Pickups, Microphones, etc.

EXPERIMENTS have shown that ceramics of high dielectric constant, such as the titanates, can be endowed with piezoelectric properties by placing them in a strong electric field. The residual piezoelectric effect in barium titanate, for example, is comparable in strength with that of Rochelle salt, and a gramophone pickup making use of prepared ceramic strips is described in the December, 1948, issue of *Electronics*. This pickup which is called the "Titone" and is marketed by the Sonotone Corporation, Elmsforth, New York, gives an output of 0.75 volts at 1,000 c/s on a standard test record.

The chief advantage of barium titanate as a piezoelectric element is that, unlike Rochelle salt, it is unaffected by moisture. Its disadvantage is that it is brittle, but this has been overcome by soldering to a metal support. On cooling, the solder contracts more than the ceramic, and subjects the latter to longitudinal compression; this is said to prevent fracture in use.

When the ceramic leaves the kiln after firing, it has a polycrystalline structure with random orientation of the grains. According to an article in the previously mentioned issue of *Electronics*, contributed by members of the research organization of the Gulton Manufacturing Corp'n. Metuchen, New Jersey (manufacturers of the crystals) "in-

dividual cubic crystals are twinned within themselves (optical axes of different domains of a crystal are at 90 degrees to each other). When the polarizing potential is applied, the domains of one orientation grow gradually, at the expense of the other, so that, finally, the crystal approaches a single domain. This growth of one domain and shrinkage of the other can be seen with a microscope, using polarized light."

The induced piezoelectric property is lost if the temperature of the ceramic is raised to the Curie point (120°C in the case of barium titanate), but it is claimed that the sensitivity remains constant over the range -70 to +70°C.

Special techniques have had to be devised to prepare sheets of the material of the required uniformity and thickness. Elements of the required dimensions are then cut from these sheets by an abrasive wheel. The activating process is varied according to the thickness of the material and is a product of the polarizing voltage and the time of application. Generally, the time required is less than an hour with polarizing voltages limited to 100 volts per mil. (0.001in). For more rapid production, the voltage can often be increased if the form of the element and its electrode assembly can be designed to reduce corona effects.

WORLD OF WIRELESS

A.M./F.M. Tests from A.P. ♦ Centimetric-wave Television Link ♦ Amateur Bands ♦ Recording and Reproduction Standards

E.H.F. Broadcasting Tests

IT will be recalled that, as suggested by *Wireless World*, the B.B.C. intends to make a full scale trial of both a.m. and f.m. broadcasting in the c.h.f. band from the new station at Wrotham, Kent. As this is unlikely to be ready for some time experimental transmissions with both methods of modulation are being radiated from Alexandra Palace. In addition to the f.m. transmissions on 90.3 Mc/s, which, after a break of some weeks for aerial overhaul, have been restarted, amplitude modulation on 93.9 Mc/s is being used.

Both transmitters carry the Third Programme every day from 6 p.m. to midnight and in addition the f.m. transmitter radiates the Light Programme from 11 a.m. to 12 noon and from 2.30 to 4.30 on Mondays to Fridays, inclusive.

Vertical polarization is normally used for both transmissions but the B.B.C. points out that horizontal polarization may be substituted at any time and, moreover, the operating schedule is liable to alteration.

4.5-cm Television O.B. Link

B.B.C. engineers, in collaboration with radio manufacturers, are investigating the possibilities of using micro-wave radio links for transmitting television from outside broadcast points to Alexandra Palace. Tests have been made between Alexandra Palace and Broadcasting House and places as far afield as Ascot and Aldershot.

The transmitting equipment consists of a klystron oscillator operating on a wavelength of 4.5 cm, which is frequency modulated by the vision signal, and a 4ft diameter paraboloid reflector with a waveguide feed. The power of the transmitter is about 700 mW and the aerial gain is 5,000. A similar aerial system is used at the receiving end. The actual transmitter and receiver are built into the back of the paraboloid reflectors, whilst the associated equipment is housed in cases.

Dividing Amateur Bands

FOR some time the Radio Society of Great Britain has been considering the possibility of introduc-

ing a voluntary plan for the reservation of a section of each of the amateur bands for the exclusive use of telegraphy.

The plan, which has been drawn up on the replies received to a recent questionnaire, has been submitted to member societies of the International Amateur Radio Union in the hope that it may be adopted by other amateurs in Region 1.

We give below the division (P, 'phone; T, telegraphy) as it applies to the bands at present in use and, in parentheses, for the additional bands allocated at Atlantic City but not yet used by British amateurs.

3.5	—	3.6	T
3.0	—	3.635	P
3.685	—	3.8	P
(3.0	—	3.8	P)
7.0	—	7.05	T
7.05	—	7.3	T & P
(7.05	—	7.15	T & P)
14.0	—	14.15	T
(14.0	—	14.1	T)
14.15	—	14.4	T & P
(14.1	—	14.35	T & P)
(21.0	—	21.15	T)
(21.15	—	21.45	T & P)
28.0	—	28.2	T
28.2	—	30.0	T & P
(28.2	—	29.7	T & P)

It will be seen that no division is proposed for the 1.7-Mc/s band or for those above 30 Mc/s.

Acoustics Standards

SOME months ago the British Standards Institution set up an Acoustics Standards Committee under the chairmanship of H. L. Kirke (B.B.C.). From this main committee were formed eight technical committees each responsible for a different aspect of the main subject. The task of the first of these, which meets under the chairmanship of Dr. R. W. Robinson

MORE COPIES OF "WIRELESS WORLD"

The recent decision of the Government to increase the allowance of paper for technical periodicals makes it possible to print more copies of *Wireless World*. Starting with the August issue (published 26th July) there should be enough for all anticipated requirements. But the number of copies will still be limited, and so it will be necessary for an order to be placed with a newsagent.

(N.P.L.) is to prepare Standards defining terms and definitions used in acoustics, and also to review the proposed American Standard for acoustical terminology.

The other committees deal with architectural acoustics and sound insulation (chairman, A. T. Pickles, D.S.I.R.); noise measurement (N. Flemming, N.P.L.); audiometers and hearing aids (R. S. Dadson, N.P.L.); electro-mechanical sound recording and reproduction (R. W. Lowden, B.S.R.A.); magnetic sound recording and reproduction—film, tape, wire and disc (M. J. Pulling, B.S.R.A.); concert pitch (Llewellyn S. Lloyd); and loudspeakers, microphones and other electro-acoustic transducers (W. West, G.P.O.).

The committee dealing with magnetic sound recording is continuing the work of a provisional committee which has recently produced a draft Standard for magnetic-tape recording for broadcasting. This specifies the requirements necessary for the interchangeability of recordings and is based on recommendations made by the B.B.C.

Naval Commissions

A SCHEME for short-service commissions in the Electrical Branch of the Navy, previously restricted to those with commissioned service in the R.N.V.R., has been extended to include men who have held commissions in the Army or R.A.F. and undertaken electrical or radio duties, and to civilians possessing suitable qualifications.

Ex-Army and R.A.F. candidates must be under 35 and civilians under 30. The latter must have a degree or diploma in electrical engineering or science, or be graduate members of the I.E.E. or Brit. I.R.E., or have passed such examinations as are recognized by these Institutions as qualifying for graduate membership.

The period of service will be five years on the active list and four years on the emergency list. A gratuity of £500 tax free will be granted to officers completing five years on the active list. Further particulars are obtainable from the Director, Naval Electrical Department, Admiralty, Queen Anne's Mansions, London, S.W.1.

Hospital Television

GUY'S HOSPITAL, London, has installed permanent closed-circuit television equipment as an aid to surgical instruction. The apparatus comprises basically the C.P.S. Emitron camera, operating on the British standard 405-line system, but has been designed by E.M.I. entirely for its special function, being built as an integral

World of Wireless—

part of the "shadowless" lighting equipment over the operating table. Thus a virtually unlimited number of students can see an operation from an ideal viewing position just above the surgeon's hands. Lens selection and focusing are remotely controlled from a room adjoining the theatre. Close-up, life-sized and reduced views may be selected.

Australian Television

THE recent demonstrations of Pye television equipment in Australia, to which reference was made last month, has called forth an official statement from the Commonwealth's P.M.G. He has stated that the demonstrations, which were given on a closed circuit, "will contribute very little toward the introduction into Australia of a television service . . . The Government has not committed itself to the provision of a television service in any Australian centre and does not intend to do so until proposals, which are now being formulated, have been submitted to the Australian Broadcasting Control Board and the Postal Department."

It is understood that tenders for equipment of varying standards, manufactured in the Commonwealth, Great Britain, U.S.A., France and the Netherlands, are being considered. These have been submitted in response to the invitation made some months ago for the supply of 5-kW transmitters for Sydney and Melbourne, or alternatively for 5-watt stations for each of the six State capital cities.

Our Sydney contemporary *Radio Electrical Weekly* states that 25-watt sound and vision transmitters were used to feed 19 standard Pye receivers via a 75-ohm co-axial cable.

Radar Certificates

RECOMMENDATIONS made by the Radar Training Committee of the Radio Officers' Union for radar maintenance certificates for radio officers have been adopted by the Ministry of Transport.

Provision is now made that a holder of a first-class Admiralty certificate with a year's experience on a radar set at sea, during the last two years, may receive the M.O.T.'s radar maintenance certificate without further examination. Holders of a second-class Admiralty certificate, or those who have completed an Admiralty radar course but have not taken an examination, and who in both cases have served afloat as above are exempt from the practical part of the examination for the certificate.

Application forms are obtainable from the Ministry.

OBITUARY

We regret to record the death of **Dr. E. H. Colpitts**, inventor of the oscillator circuit which bears his name, at the age of 77. He retired from the vice-presidency of the Bell Telephone Laboratories some time ago. He was recently awarded the Cresson Medal of the Franklin Institute, New York, for his work on the development of long-distance radio communication.

We also record with regret the death at the age of 79 of **Admiral H. W. Grant**, C.B., who was chairman and managing director of Marconi's W.T. Co. from 1941 to 1946. He specialized in navigation during his naval career and was for two years in command of the Navigation School at Portsmouth. On retirement from the Navy in 1918 he joined the Eastern Telegraph Company as managing director and was on the Boards of a number of other cable companies.

PERSONALITIES

Sir Ernest Fisk, managing director of E.M.I., has been re-elected president of the International Federation of the Phonographic Industry at a general meeting of the Federation in Amsterdam attended by representatives of twelve countries.

Brigadier J. B. Hickman, C.B.E., M.C., M.A., has been appointed managing director of British Telecommunications Research, Ltd. For four years prior to leaving the Army in March, he had held the position of Director of Telecommunications Research and Development in the Ministry of Supply. Brigadier Hickman has been in radio throughout his army career and filled many technical administrative posts, among them Asst. Commandant, Wireless Wing, School of A.A. Defence; Deputy Chief Inspector Telecommunications, Inspectorate of Electrical and Mechanical Equipment (1941/44), and Deputy Director of Signals (Equipment) at the War Office (1944/45). He was at the radar research station at Bawdsey in 1938.

W. T. Ditcham, personal assistant to the engineer-in-chief of Marconi's, has retired after 34 years' service with the company. He began his radio career



W. T. DITCHAM.

in 1906 with the De Forest Wireless Telegraph Syndicate, which, on acquiring the Poulsen arc patent, became the

Amalgamated Radio Telegraph Company. He was associated with H. J. Round in the early development of direction finders and operated Marconi's experimental broadcasting station at Chelmsford in 1920. Prior to 1939 Mr. Ditcham was in charge of the development of broadcasting transmitters at the Chelmsford works.

W. E. Dickinson, who joined the Gramophone Company in 1936 and has for some time been in charge of the company's technical publications division, is now to specialize in the sale of schools' radio and gramophone equipment.

R. J. Dippy, O.B.E., B.Sc., who, as one of the original team at the Bawdsey Research Station, was responsible for the development of Gee, is leaving the Ministry of Supply, where he is senior principal scientific officer, to become Controller of Telecommunications (Civil Aviation) for the New Zealand Government. Before going to Bawdsey Manor in 1936 he was for two years in the G.E.C. Research Laboratories, Wembley.

Leslie Gamage, vice-chairman and joint managing director of G.E.C., has been re-elected chairman of the Overseas Standards Advisory Committee of the British Standards Institution and, for the seventh successive year, has been re-elected president of the Institute of Export.

A. Miall-Allen has been appointed by Taylor Electrical Instruments, Ltd., as sales engineer for the company's panel instruments.

S. L. Robinson, B.E.M., who has been with Masteradio, Ltd., for over twelve years as general manager and latterly was in charge of research and development engineering, has joined Sargrove Electronics, Ltd., who are now at Effingham, Surrey, as general manager.

R. O. Seccombe, who has been with Murphy Radio for some twelve years, has succeeded **J. Wilson** as service department manager. As announced recently, Mr. Wilson has been appointed general manager of Murphy Radio (India), Ltd.

R. T. B. Wynn, C.B.E., assistant chief engineer, B.B.C., has been nominated chairman of the I.E.E. Radio Section for 1949/50 and **D. C. Espley**, D.Eng., of the G.E.C. Research Laboratories, vice-chairman.

IN BRIEF

Licences.—An increase of 113,650 broadcast receiving licences (including 6,400 for television) during March brought the total to 11,753,150. The month's increase was a record; the increase for the whole of last year being only 400,000. The March total included 126,500 television licences.

B.B.C. Transmitters.—Two new air-cooled medium-wave transmitters have been ordered by the B.B.C. from Marconi's. By using forced-air cooling to dissipate the heat generated by the valves, it has been possible to considerably reduce the overall size of the equipment. Both 100- and 50-kW m.w. and s.w. transmitters are available with air cooling. The 120- and 150-kW sets in this range are water-cooled.

THE "BELLING-LEE" PAGE

Providing technical information, service and advice in relation to our products and the suppression of electrical interference

How is your earth ?

Only last month we received a letter in which the writer explained that as he lived in a block of flats, he could not do better than a tin seven inches square and three inches deep, full of earth. This was shown to our engineers, one of whom assured us that when investigating a recent case of interference, he found a radiogram "earthed" to a small flower pot, the soil of which was kept "suitably moist." We thought that everybody had grown out of this sort of thing, and we would like readers to emphasise to their friends that the use of a good efficient "solid" earth is highly desirable in the interest of reduction of interference and safety. Incidentally the earth pin of a three pin supply point is not the ideal earth for a receiver from the interference point of view, although it is the right way

to "earth" an appliance and is often the most convenient to use.

Suppression of motor vehicles with magneto ignition.

We have been asked what to do in these circumstances. BS.CP.1001 recommends the use of a sparking plug suppressor L.1143 on each plug. Should you be so placed, for a four cylinder engine suppressors will cost you 4 at 1/6 = 6/- instead of 2/- for a "Belling-Lee" distributor suppressor L.630.

Protection of aeriels.

There are only a few things to be said in favour of light alloy television aeriels, they are light, they do not rust, and the raw material is readily available. Those of you with steel aeriels, whether broadcast or T.V. should paint them every year or so. A good time to do this is when your

house is being redecorated and there are ladders about the place. We repeat, even lamposts, park railings and bridges are painted regularly, and not for appearance.

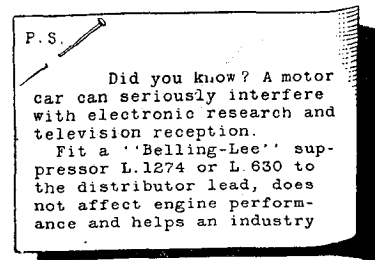

This is a reproduction of a "Belling-Lee" letter sticker

We were very pleased to see so many old friends and to welcome new acquaintances at the B.I.F. and we look forward to meeting them all again at Radiolympia in the Autumn.

Cutting down London T.V. aeriels to make them suitable for the Midland station.

No it won't do! We have said so before, and must repeat it, as so many people write and ask if they need only cut a piece off the element. The length of the crossarm is also a function of the wavelength, and this should be cut to the same length as the element, which raises all kinds of complications when you try to do it.

TELEVISION AERIAL LIST NUMBERS

The list numbers of television aeriels have been subject to alteration and should be read as follows :-

MIDLAND FREQUENCY AERIALS

- L652/LM** Dipole, reflector and cross arm, 8ft. light alloy mast, chimney lashing and fabricated iron bracket (in 3 packs).
- L652/C** Dipole, reflector and cross arm with mast head adaptor L651 for 2½ in. dia. wood mast (in 2 packs less mast).
- L652/L** As above but with lashings and brackets for customers own mast (in 3 packs). *See below.

LONDON FREQUENCY AERIALS

- L502/L** Dipole, reflector and cross arm with mast-cap, chimney lashings and brackets for customer's own mast (one package).
*A mast is not supplied, but a limited supply of poles, of slightly varying diameters is available, reference number Y7981. Die-cast wedges are supplied with masts, free of charge, to provide packing between mast and mast cap.
- L502/C** Dipole, reflector and cross arm with mast-cap. For customer's own mast (one package).

TYPES UNCHANGED

Midland Versions.	Description.	London Versions.
L647/T	Dipole with wall fixing bracket	L502/T
L647/L	Dipole with chimney lashings	L501/L
L646	"Veerod" attic aerial	L605
L635	"Veerod" chimney aerial	L606
L678	"Doorod" indoor aerial	L645

A reliable 10 m/A fuse.

We have perfected a method for the production of fuses rated at 10, 15 and 25 m/A blowing within one second on 100 percent. overload. The link is pure platinum wire, and complete cartridge is 5/8 in. x 3/16 in. corresponding to our list No. L.562. These fuses pass the bump test specified in R.I.C./11 for yellow and green component categories. The appropriate fuseholders are panel L.575, sealed panel L.565, open baseboard L.566. All these fuseholders have Service reference numbers.

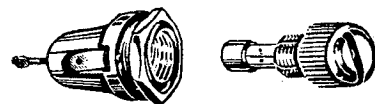

The illustration shows miniature panel fuseholder L.575. Regd. Design No. 843289.

BELLING & LEE LTD
CAMBRIDGE ARTERIAL RD., ENFIELD, MIDDX., ENGLAND



... but there is a difference in **VITAVOX** sound equipment

The GP 1 pressure Type Loudspeaker Unit is an outstanding example of advanced design and craftsmanship. Compact with high power handling capacity, efficient and economic in weight and cost, the GP 1 unit emphasises the quality of VITAVOX sound equipment.



Retail Price:
£9. 10. 0.

VITAVOX LTD., WESTMORELAND ROAD, N.W.9. Telephone: Colindale 8671

G.E.C.

QUARTZ CRYSTAL UNITS

FOR STABLE FREQUENCY GENERATION

FEATURES

Low temperature co-efficient—less than 2 in 10 million.
Patented nodal suspension. Mounted in vacuum, performance independent of climatic conditions. Exceptionally high Q value.
High stability. Small size, 3" x $\frac{5}{8}$ " overall excluding pins. Fits standard miniature deaf aid valve socket.

FOR FREQUENCY SUB-STANDARDS

Type JCF/200, 100 KC/S. Available from stock adjusted to 0.01%. Higher accuracies supplied to special order.

The type JCF/200 unit illustrated is representative of the wide range of vacuum type unit available for low and medium frequencies.

PRICE
£2 - 15 - 0

SALFORD ELECTRICAL INSTRUMENTS LTD.
PEEL WORKS, SALFORD 3, LANCs. Telephone BLAckfriars 6688 (6 lines). Telegrams & Cables SPARKLESS Manchester
Proprietors THE GENERAL ELECTRIC CO., LTD., OF ENGLAND

Exporting Television.—A receiver designed to American television standards (525 lines), was featured by Romac Radio Corporation at the B.I.F. It incorporates switch tuning covering twelve of the thirteen U.S. television channels (54 to 216 Mc/s).



SPECIALLY CONSTRUCTED housing for the image-orthicon camera outside the B.I.F., Birmingham, where 625-line television was demonstrated.

Centimetric Experiments.—In order to extend the quasi-optical path for experimental transmissions on centimetre wavelengths, the G.E.C. is to erect a 200-ft tower at the Company's research laboratories at Wembley. Two octagonal cabins, about 11ft across, will be fitted one above the other at the top of the lattice steel tower. A lift will give access to the cabins on the external balconies of which will be fitted paraboloidal aerials.

I.E.E. Growth.—In the annual report of the Council of the I.E.E. an increase during the past year of 1,464 in the membership is recorded. This brings the total to 34,371. Nearly 16,000 are Students and Graduates.

Sound Reproducing equipment, with individual volume control and selection of two programmes for each pair of headphones, is being produced by the Magneta Time Company for installation in hospitals.

P.A.—Two public-address installations have recently been undertaken by the Sound Amplification Division of E.M.I. Amplifying equipment giving an output of 400 watts to 53 loudspeakers has been installed at the Rugby Football Union ground at Twickenham. A contract to supply a complete p.a. installation for the mills of the Madura Mill Co. at Madura, Southern India, has also been placed with the company.

Ships' Aerials.—A centralized aerial system for the personal receivers used in various parts of the ship is being installed by E.M.I. in each of the five vessels now being built in Trieste for the Argentine Government.

"Try This One."—Don't read this until you have tried to solve the problem propounded by "Diallist" on p. 239. The answer is, the length of the line cord is five feet, the age of the elder brother being ten years.

Marine Radar.—The symposium of thirteen papers on the operational aspects of marine radar which was presented at a meeting of the Institute of Navigation in February is published in the April issue of the *Journal* of the Institute.

British Wireless Dinner Club.—The 25th annual dinner of the club was recently held in London. The guest of the evening was Lord Cherwell, P.C., F.R.S. The newly elected president of the club, which now has a membership of 450, is A.V.-M. Lywood, C.B., C.B.E.

FROM ABROAD

French Television.—Demonstrations of 819-line television—the new French standard—were given throughout the recent Lyons Fair. Mobile equipment was used for the transmissions which were radiated on 213.25 Mc/s (vision) and 202.1 Mc/s (sound) with powers of 60 and 15 watts, respectively.

North American Amateurs.—Canadian and U.S. amateurs are now permitted to use the 1.8 to 2-Mc/s band. It has been divided into bands of 25 kc/s and these have been allocated for use in individual States and Provinces. Transmission is permitted on both 'phone and c.w., but power is limited.

Newfoundland.—In order to link Newfoundland, which has recently become a Province of Canada, with the Canadian Broadcasting Corporation's network, an f.m. link has been established between the mainland and the island.

Ionosphere Data.—The U.S. National Bureau of Standards has issued a five-page booklet entitled "Absorption of Radio Waves Reflected at Vertical Incidence as a Function of the Sun's Zenith Angle" (RP1939) in which is analysed the diurnal variation of ionospheric absorption. It is obtainable, price 10 cents, from the U.S. Government Printing Office, Washington 25, D.C.

Pakistan.—The firm of Butler and Khan, importers and agents, of Muhamed Building, Bunder Road, Karachi, 1, invite manufacturers to send details of radio equipment which they are desirous of exporting to Pakistan.

"**Broadcasting Yearbook,**" which is published by our Washington contemporary, *Broadcasting*, and is issued to subscribers to that journal, contains a wealth of information on broadcasting in the U.S.A. The 1949 edition includes complete lists of American a.m., f.m. and television stations.

INDUSTRIAL NEWS

De la Rue Plastics.—The two wholly owned plastics subsidiaries of Thomas De la Rue (De la Rue Installation, Ltd., and Hill, Norman & Beard Plastics, Ltd.) are no longer acting as individual companies, but will operate from 84, Regent Street, W.1 (Tel.: Regent 2901), as the plastics division of the parent company.

H. J. Enthoven & Sons have transferred all their departments to their new offices at "Enthoven House," 89, Upper Thames Street, London, E.C.4 (Tel.: Mansion House 4533).

Radio Industries Club.—In the annual report of the chairman of the Radio Industries Club the membership of the parent club is given as 673 and the total of the six affiliated clubs—Scotland, Merseyside, Manchester, Midlands, Wales and Monmouthshire, and West Riding of Yorkshire—as approximately 750. The new president is Lord Burghley, K.C.M.G., and W. E. Miller, Editor of our associate journal *Wireless & Electrical Trader*, who has been honorary secretary of the club for eight years, is this year's chairman and continues as secretary.

R.C.M.F. now R.E.C.M.F.—At the 16th annual general meeting of the R.C.M.F. it was agreed to amend the title to Radio and Electronic Component Manufacturers' Federation. The member firms and, in brackets, their representatives, elected to the council for 1949-50 are:—Antiference (N. S. Beebe); British Electrolytic Condenser (P. D. Canning); British N.S.F. (S. Wilding Cole); Ediswan (J. W. Ridgeway); Garrard (Hector V. Slade); Hellermann (J. Bowthorpe); A. H. Hunt (F. S. Richmond); Long and Hambly (G. G. Kent); Reliance Electrical Wire (C. H. Davis); Telephone Manufacturing (W. A. Jackson); Telegraph Construction and Maintenance (W. F. Randall); and Win-



C. H. DAVIS, chairman, R.E.C.M.F.

grove and Rogers (W. Holmes). The new chairman is C. H. Davis and the vice-chairman H. V. Slade.

MEETINGS

Television Society

Midlands Centre.—"The V.H.F. Link," by A. H. Mumford (G.P.O.) at 7.0 on June 1st at the Chamber of Commerce, New Street, Birmingham.

Junior Institution of Engineers

Midland Section.—"The Manufacture of Gramophone Records," by H. W. Bowen, O.B.E., at 7.0 on June 4th at James Watt Memorial Institute, Great Charles Street, Birmingham.

Radio Controlled Models Society

London Group.—Second of three lectures on "Fundamentals of Radio Control," by P. A. Cummins at 2.0 on June 12th at St. Ermins Hotel, Caxton Street, London, S.W.1.

Institution of Electrical Engineers

Southern Centre.—Visit to the R.A.F. radar station at Poling, near Arundel, on July 1st.

"MIDGET A.C. MAINS RECEIVER"

Further Notes, and Answers to Some Queries

SINCE the appearance of this article in the March issue it has been found that the quality and undistorted power output of the receiver can be improved by the use of an output transformer different from the ex-Air Ministry type visible in one of the photographs. This component, which was originally designed for a rather different function, is to some extent responsible for the modulation of high notes by low, mentioned in the article. To obtain the best quality and the maximum output of which the receiver is capable, and in particular where a larger external speaker is used, a bigger output transformer with a core at least $2\text{in} \times 1\frac{1}{2}\text{in}$, having a centre cross-section of $\frac{1}{2}\text{sq in}$, should be used. The laminations in this size of transformer are normally butted together to give a small air gap in the magnetic circuit. By dismantling the transformer and re-assembling it with the laminations interleaved, the inductance can be appreciably increased and the bass response correspondingly improved. This improvement in inductance is only possible, of course, because the anode current of the output valve is so small.

Nevertheless some constructors have found the quality quite adequate with the original output transformer, and details are given below for obtaining the ratios of 35:1 and 80:1 with this component.

35:1, primary TP and I₄ with IP bonded to O₄ secondary O₃ and I₃.

80:1, primary OP and I₄ with IP bonded to O₄ secondary O₃ and T₃.

It is regretted that an error occurred in the specification for the midget mains transformer. The core cross-section should be $\frac{3}{4}\text{sq in}$ not $\frac{1}{4}\text{sq in}$ as stated. A suitable component can be obtained from Stern Radio, 109, Fleet Street, London, E.C.4.

It should be pointed out that the reaction control is a pre-set adjustment intended to be set below the point of oscillation for all

settings of the tuning control, and that this setting should be adjusted to give optimum sensitivity and selectivity. The brief period of oscillation during warming up of the receiver occurs only if reaction is pressed to the limit.

Some of the war-surplus EF50 valves are somewhat microphonic and give trouble in the detector position, particularly when the receiver is boxed. Care should therefore be taken to select a suitable valve for this position.—S. W. A.

MANUFACTURERS' LITERATURE

Four leaflets describing radio connecting wires, television down-lead cables, microphone and loudspeaker cables, and copper earth rods made by B.I. Callender's Cables, Norfolk House, Norfolk Street, London, W.C.2.

Illustrated guide to the products and resources of the British Thomson-Houston Co., Rugby, issued in connection with their exhibits at the British Industries Fair.

Leaflet in English, German, Spanish and French describing "Superspeed Special" activated solder made by H. J. Enthoven and Sons, 15-18, Lime Street, London, E.C.3.

Preliminary specification of "Sound Magnet" tape recorder made by General Lamination Products, 294, Broadway, Bexleyheath, Kent.

Leaflet describing a 20-watt, 12-inch Model R22/12 p.m. loudspeaker made by Goodmans Industries, Lancelot Road, Wembley, Middlesex. Altern-

tive cones are available with fundamental resonances of 55 c/s or 75 c/s.

Illustrated leaflet of Model 72 table model receiver (export only) from In-victa Radio, Parkhurst Road, London, N.7.

List of quartz crystal units made by Salford Electrical Instruments, Silk Street, Salford, 3, Lancs.

Catalogue of "Stanelect" public address loudspeakers for all purposes, from the Standard Electrical Engineering Co., 16, Heneage Lane, London, E.C.3.

Leaflet describing Models CN385 and CN386 a.c./d.c. superhet receivers (export only), from Vidor, West Street, Erith, Kent.

Catalogue of radio components and kits of parts from Coulphone Radio, 58, Derby Street, Ormskirk, Lancashire.

Technical details of the G.E.C. "Overseas" bandspread auto-change radiogram, from the General Electric Co., Magnet House, Kingsway, London, W.C.2.

Leaflet describing the universal oscillograph mounting made by Nagard, Ltd., 245, Brixton Road, London, S.W.9.

Technical details of Eddystone Model 680 communications receiver from Stratton and Co., Eddystone Works, West Heath, Birmingham, 31.

MULLARD VALVE DATA

THE information contained in the wall chart of Mullard receiving valves has now been incorporated in a pocket-size booklet for the convenience of servicemen. In addition to full characteristics, operating data and base connections, there is a comprehensive list of equivalents and near equivalents of valves of other makes. Copies are obtainable from Mullard Electronic Products, Century House, Shaftesbury Avenue, London, W.C.2.

NEON TEST PROD

AN insulated test prod containing a small neon lamp which can be used on either a.c. or d.c. circuits of 200 volts and over has been introduced by A. F. Bulgin & Co., Ltd., By-pass Road, Barking, Essex. It gives polarity indication on d.c. and enables a.c. or d.c. supplies to be identified by the nature of the glow. Its many uses comprise means of locating a blown house fuse, testing motor car sparking plugs, leakage tests on capacitors, continuity of supply circuits and for identifying transformer windings. The prod is very sensitive and gives an indication of leakage through several megohms.

A standard size neon bulb is used so it is easily replaceable if necessary. The whole is fully shrouded in rubber and has semi-flexible

P.V.C.-covered prod leads terminating in ferruled tips. The price is 10s.

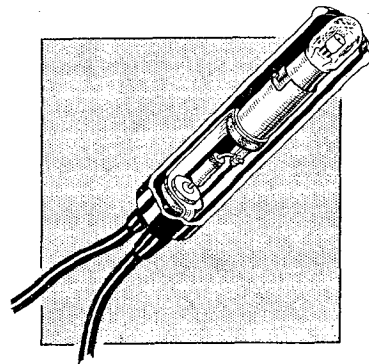

Bulgin insulated neon test prod.

ELECTRONIC CIRCUITRY

Selections from a Designer's Notebook

By J. McG. SOWERBY (Cinema Television Ltd.)

THOSE readers fortunate enough to have visited the Physical Society's exhibition last April will probably have noticed the large number of instruments involving electronic counters. These circuits were first widely used in nuclear physics research for counting the individual pulses derived from Geiger-Muller tubes, and other devices.¹ Since then the field of application of counters has been greatly extended, and numerous counting circuits have appeared in the technical literature.

Electronic Counters

Electronic counters may be used for recording and controlling the flow of articles past a given point—as in the manufacture of buttons and cigarettes—when the counting rate is in excess of that which can be handled by a mechanical counter. In such industrial applications the articles are often made to interrupt a beam of light falling onto a photocell, and then each interruption produces a pulse which is counted as one integer. Of course, other means are available for deriving the required pulses from the passage of an article. Counters are also used for recording the number of revolutions executed by a piece of rotating machinery in a given time, for recording the number of cycles executed in a given time (e.g., measuring cycles per second), for the accurate measurement of intervals of time, and for frequency division. The electronic counter is also the basis of the well-known ENIAC computing machine.

Probably one of the simplest forms of counter is the so-called scale of two which usually consists of two valves so connected that the circuit has two similar stable states, and which will change from one to the other each time it

receives a pulse of predetermined shape and amplitude. Such a scale of two circuit is shown in Fig. 1, and this represents a simple reliable design.² It will be seen that the circuit is entirely symmetrical, and that each anode is connected through a resistive network to the other valve's grid. If the R_2 and R_3 resistances are chosen correctly, it is possible to arrange matters so that when one valve is conducting, the drop across its anode load is partially transferred to the other's grid, so that the latter is cut off. Since the circuit is entirely symmetrical it is a matter of chance which valve becomes conducting when power is first supplied to the circuit; let us arbitrarily assume that it is A which is conducting, and go round the circuit to see how the standing voltages are distributed.

Since A is conducting and B is not, the anode of A will be negative with respect to B's,

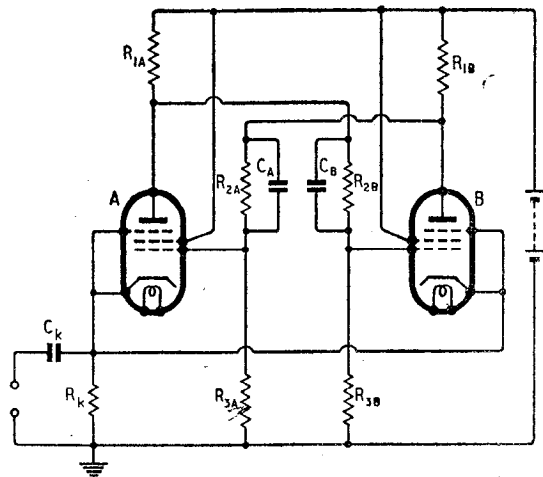

Fig. 1. Scale of two counter circuit.

and the difference may well be anything between 20 and 100 volts in a practical design. Consequently the grid of A will be more positive than that of B by $R_3/(R_2 + R_3)$ times the difference in the anode potentials. Provided R_k is made sufficiently large, no grid current will flow, and the anode current of A will be nearly its grid potential divided by R_k . When B is conducting all the foregoing will again be true if A and B are interchanged, and the function of all the resistors and the valves is

apparent. We have not yet discussed the function of the two condensers C_A and C_B —which are equal in value.

To appreciate the need for the two condensers, we must now enquire how the scale of two is made to change from one stable state (A conducting) to the other (B conducting). In this circuit positive pulses of short duration are applied to the cathode, so that for the whole or part of each pulse both A and B are cut off. This pulse may last anything between 0.1 and 50 μ sec, according to the particular design and the requirements, but its length must be properly related to the short time-constant formed by C_A and C_B and their associated resistances. To show how essential are these

condensers, assume first that the input positive pulse is indefinitely long. This cuts off both valves and before very long the circuit is in an entirely symmetrical state, since C_A and C_B will assume equal charges. If the pulse now returns to zero both valves conduct, and the circuit is in a state of unstable equilibrium. By regeneration one or other will soon become fully conducting and the other will cut off. But there will be nothing to decide which valve shall become fully conducting (except, of course, any small practical lack of sym-

¹ "Electrical Counting," by W. B. Lewis, C.U.P., 1942.

² T. C. Nuttall, Brit. Pat. No. 572884.

Electronic Circuitry—

metry) and the circuit will not behave as a scale of two.

But now suppose the input pulse to be very short in duration compared with the time-constant of C and its associated resistances. As A is initially conducting there is a greater potential across (and so more charge stored in) C_A than C_B . Consequently, when both valves are first cut off the grid of B moves positively with respect to A's. The grid potential of B then reverts exponentially with time towards that of A, but before equality is attained the input pulse collapses leaving B passing a greater anode current than A—or the conditions may be such that A is cut off. Consequently, the circuit locks into its second stable state with B alone conducting. Thus we see that the condensers C_A and C_B form an essential feature of the design, and that the circuit cannot be expected to function correctly without them. They form a kind of "memory" which enables the circuit to remember, for a short

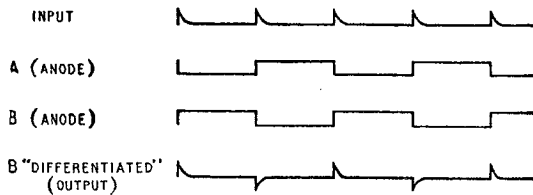

Fig. 2. Simplified waveforms in the scale of two counter.

time after the onset of the energizing pulse, which state it was in last, and ensures that it shall change to its other state. The function of the condensers has been discussed at some length because they are often wrongly described as being merely "sharpening" condensers to compensate for the stray grid-cathode capacitance of the valves, or to make the anode-grid transmission independent of frequency.

In the scale of two circuit shown in Fig. 1 the energizing pulse is coupled into the cathode through C_k , and it is generally not necessary for this pulse to be anything more precise than the positive "spike" resulting from the differentiation of a square wave. Fig. 2 indicates the general shape of the relevant waveforms in the circuit, and also

the waveform obtained by differentiation of the anode potential changes of one valve. From this one sees that one output positive spike is obtained for two at the input, so that the circuit divides pulses by two. Obviously if we can arrange that the unwanted negative spikes are not transmitted, we can use the remainder to operate another scale of two. This is conveniently done by means of a buffer stage as shown in Fig. 3.

This consists simply of a short time-constant differentiator $C_g R_g$, and a cathode follower biased to cut-off by the current through R_k caused by the return of R to the h.t. supply. If this stage is fed with square waves—or the anode waveform of the scale of two circuit—the positive and negative spikes in the last waveform of Fig. 2 will appear at the grid of the valve, but the negative ones will be largely suppressed, and the positive ones may be used for driving the next scale of two, or for any other purpose. Hence with this design three valves

constitute a complete scale of two, and any number of them may be arranged in cascade. The division ratio of such a cascade is 2^n , where n is the number of scales of two. Thus we may easily obtain division ratios (or scaling factors)

of 2, 4, 8, 16, 32, 64, 128, 256, 512, 1024, 2048 . . . and so on.

It must be emphasized at this stage that the circuits shown in Figs. 1 and 3 are not by any means the only ones available, and that a large number of variations is possible. For example, the input pulses do not necessarily have to be applied to the cathodes, nor do they always have to be of one sign, and counters can be designed to accept mixed positive and negative pulses but to respond only to those of one sign. They may be fed into the circuit in many ways—at the control, screen, or suppressor grids, or at the anodes—provided the pulses are supplied symmetrically to the circuit. Again, various circuits have been designed using diodes as part of the input coupling, in

which the aim is to apply the input pulses alternately to the two valves. Triodes or pentodes may be used, but generally speaking pentode circuits are easier to design owing to the absence of Miller effect. The "memory" need not consist of a condenser

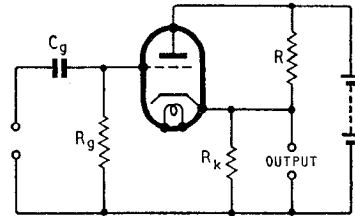

Fig. 3. Cathode-follower buffer circuit.

and associated resistances; circuits have been designed in which inductances were used. However, if the mode of operation of the circuit of Fig. 1 is remembered the reader should have no difficulty in following the action of more complicated circuits.

So far, then, we have seen how a simple scale of two operates, and how any pulse repetition frequency may be divided by any number N in the series given by $N = 2^n$, where n is the number of scales of two used. Next month we shall make some observations on methods of obtaining division ratios not included in this series, and we shall see how N can be given any integral value.

NEW DOMESTIC RECEIVERS

A THREE-WAVEBAND receiver, Model BC5050, introduced by the General Electric Co., Magnet House, Kingsway, London, W.C.2, employs a four-valve, plus rectifier, superhet circuit with a single KT61 output tetrode feeding a sensitive p.m. loudspeaker, and is designed to give better-than-average quality of reproduction. It is available for a.c. mains only (£21 14s 4d including tax) or for a.c./d.c. operation (Model BC5055), price £22 7s 2d including tax.

Five wavebands are a feature of the H.M.V. Model 1120 superhet (four valves, plus rectifier), which has a 5-watt output and is fitted with spin-wheel tuning. In addition to the usual medium- and long-wave ranges, there are short-wave ranges covering 15.5-20.5 m, 20.5-33 m and 33-100 m. The price, including tax, is £26 16s 7d and the makers are the Gramophone Co., Hayes, Middlesex.

Take a look
inside the
ERIE Insulated
High Stability
RESISTOR

FULLY PROTECTED
AGAINST SOLDERING AND
MECHANICAL DAMAGE
DURING ASSEMBLY

Ceramic Case with Insulation
Resistance of more than 1,000
megohms at 500 volts.

Colour coding bands (to
R.C.S.C. standard) which
retain their true colour when
applied to the white ceramic
case.

Wire leads ($\frac{3}{16}$ in. x 0.032 in.) and
spring caps securely con-
nected to resistor body thus
eliminating open circuits.

Time-proven ceramic
end seal.

Special resistor element con-
sisting of carbon deposit on
ceramic tube, spiral cut to
required value and tolerance.



QUALITY IS BUILT INTO EVERY DETAIL

ERIE High Stability Resistors, besides displaying characteristics well within the limits laid down in the current R.C.S.C. Specification, are fully insulated, fully tropical and extremely robust; and are, therefore, eminently suitable for operation in restricted spaces and under the severest of conditions.

TYPE	WATTS	MAX. PEAK * VOLTS	MAX. BODY DIMENSIONS L. x Dia.	RESISTANCE RANGE
100	$\frac{1}{2}$	500	$1\frac{3}{8}$ " x $\frac{11}{32}$ "	10 Ω to 3 meg.
108	$\frac{1}{4}$	325	$\frac{7}{8}$ " x $\frac{1}{4}$ "	25 Ω to 1 meg.
109	$\frac{1}{8}$	250	$\frac{5}{8}$ " x $\frac{1}{4}$ "	100 Ω to $\frac{1}{2}$ meg.

*Provided wattage rating not exceeded.

All Leads axial $1\frac{1}{2}$ " long x 0.032" dia.

ERIE Resistor Limited

CARLISLE ROAD, THE HYDE, LONDON, N.W.9, ENGLAND

Telephone: COLindale 8011. Cables: Resistor London

Factories: London and Gt. Yarmouth; Toronto, Canada; Erie, Pa., U.S.A.

3332

ESSENTIALS!

THE PHASE INVERTER SPEAKER

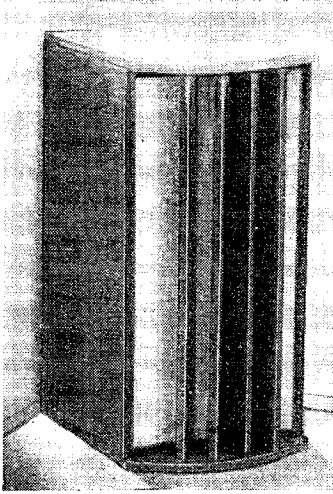

Beloved by its numerous users and flattered by imitation. Measuring only 29" high x 14" square, this instrument provides the music lovers' perfect answer to the "Baffling" problem. Response 25 to 13,000 cps; fitted with the famous Sound Sales dual suspension auditorium unit. Input impedance 6 ohms.

Price £12. 10. 0

HEAVY DUTY OUTPUT TRANSFORMER, TYPE 036, characteristic ± 1 db, from 20-20,000 cps. Price £2. 6. 8

RHO-METAL SCRATCH FILTER CHOKE

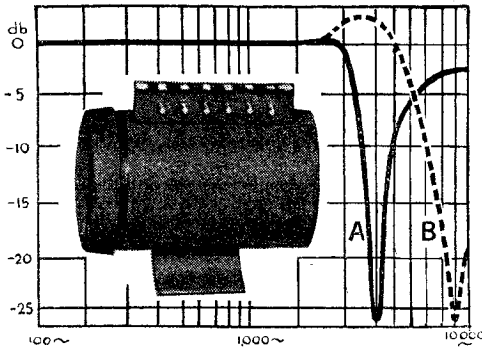

TYPICAL RESPONSE CURVES

- A Tuned for maximum rejection at 4,000 cycles
- B Tuned for maximum rejection at 9,000 cycles

WHERE SURFACE NOISE IS THE LIMITING FACTOR TO SUPREME QUALITY OF REPRODUCTION, fit a Sound Sales alloy cored steep trough tuneable filter. We know the problem of removing Surface Noise or Hetrodyne whistle is not easy to solve, but the steep trough filter has so far produced the most encouraging results we have encountered when using a compact component which can be incorporated in existing apparatus.

CHOKE TYPE. C/SF, Dia. 2 3/4", length 3 1/4". **PRICE £1.8.9** each.

Obtainable directly from Sound Sales Ltd., appointed Agents, and the best Retailers

SOUND SALES LIMITED

Showrooms & Offices: 57 St. Martin's Lane, W.C.2. Tel.: Temple Bar 4284
Works: West Street, Farnham, Surrey. Tel.: Farnham 6461/2/3

TELEVISION MINDED?

Improved Course at Greatly Reduced Price

In view of the rapidly increasing interest in Television and our large number of enrolments, we have reduced the price of our BASIC TELEVISION POSTAL COURSE by 25%. At the same time the scope of the course has been increased by including comprehensive material dealing with the latest television receiver techniques.

The course covers the examination for the Television Service Engineer's Diploma set jointly by the Radio Trades Examination Board and the City & Guilds Institute.

Where desired, selected lessons are available at an appropriately reduced price. Many other courses in RADIO, MATHEMATICS, INDUSTRIAL ELECTRONICS, etc., are available. Full details in FREE BOOKLET from:

E.M.I. INSTITUTES

Dept. 16, 43 Grove Park Road, Chiswick, London, W.4
Telephone: CHiswick 4417/8

EI38

Only with **CO-AX** P.F. CABLES

AIR-SPACED ARTICULATED

4mm/ft

Patents Regd Trade Mark

THE LOWEST EVER CAPACITANCE OR ATTENUATION

IMMEDIATE DELIVERIES FOR HOME & EXPORT

Write or cable for data sheets or deliveries to the originators of flexible air spaced R.F. cables.

TRANSRADIO LTD.
CONTRACTORS TO H.M. GOVERNMENT
136A CROMWELL ROAD, LONDON SW7
1677/60 TRANSRAD, LONDON

LOW ATTEN TYPES.	IMPED OHMS	ATTEN db/100ft at 100 Mcp.	LOADING Mcp.	OD."
A 1	74	1.7	0.11	0.36
A 2	74	1.3	0.24	0.44
A 34	73	0.6	1.5	0.88
LOW CAPAC TYPES.	CAPAC pF/ft	IMPED OHMS	ATTEN db/100ft at 100 Mcp.	OD."
C 1	7.3	150	2.5	0.36
P.C. 1	10.2	132	3.1	0.36
C 11	6.3	173	3.2	0.36
C 2	6.3	171	2.15	0.44
C 22	5.5	184	2.8	0.44
C 3	5.4	197	1.9	0.64
C 33	4.8	220	2.4	0.64
C 44	4.1	252	2.1	1.03

HIGH POWER FLEXIBLE

PHOTOCELL CABLE

VERY LOW CAPACITANCE

RECTIFIER VOLTAGE CONTROL

Using Saturable-Core Reactors

By F. BUTLER, B.Sc. M.I.E.E.

A PART from barretter lamps and gas discharge tubes, static voltage-control systems may be divided into two principal classes, one using electronic valve regulation, the other employing the properties of saturable-core reactors or transformers. D.c. power supply units operating on a.c. mains commonly employ electronic regulators to stabilize the output voltage against load current and supply voltage changes, and designs for

valve transformer is profoundly modified by the flow of d.c. anode current to the associated valve. Because of this effect, when measuring the inductance of the windings of such transformers, it is necessary to select standard values of d.c. and a.c. excitation in order that the results should correspond to some definite value for the incremental permeability of the core material.

Fig. 1 shows the relationship between the magnetizing ampere-turns per inch length of magnetic circuit plotted against the resulting flux density in lines per square inch of core cross-section.

The data refers

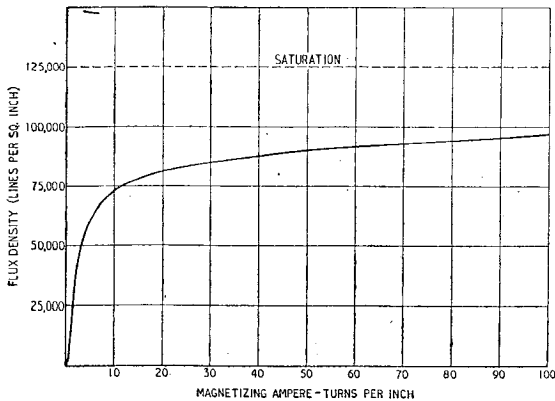

Fig. 1. Typical initial magnetization curve for transformer steel.

an extensive range of such units have been published. Close regulation and rapid response are secured at the expense of some circuit complexity.

Regulators employing magnetic saturation of an iron core are much less complicated and are preferable for use in industrial equipment where reliability is essential. They can be applied equally well to a.c. voltage regulation and to the stabilization of the d.c. output from rectifier sets. In both cases the regulator action depends on the non-linear relationship which exists between the magnetizing ampere-turns and the flux density in the iron core of a transformer or reactor. The observed non-linearity accounts for the variation of the inductance of iron-cored coils under different conditions of a.c. and superimposed d.c. magnetization. It is well known that the primary inductance of an output or inter-

superimposed on a variable d.c. biasing current, there will be different alternating fluxes corresponding to each level of direct current. If the frequency of the alternating current is fixed, there will be differing back e.m.f.s corresponding to the changing rates of flux linkage and there is thus a particular value of coil inductance corresponding to each d.c. bias level. This variable-inductance feature is the basis of design of magnetic amplifiers and control equipment using saturable reactors or transformers.

Fig. 2 shows the most elementary form of regulator using the principle of reactance variation by auxiliary d.c. bias control of the steady flux.

It can be seen that the control reactor forms a variable impedance in series with the load. Practical circuits differ from the simple arrangement shown in that there is some transfer or coupling device connected between the load circuit and the d.c. control section so as to effect the desired automatic control. In certain cases, the interconnection is by means of current transformers and auxiliary metal rectifiers. With equipment incorporating rectifiers, it may be sufficient to divert the d.c. output and employ it to exer-

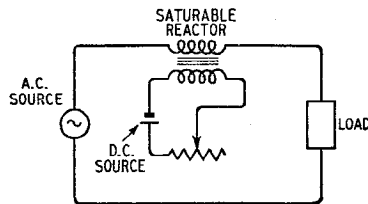
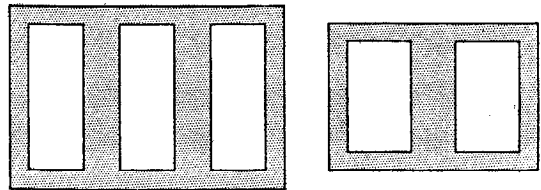

Fig. 2. Simple variable-reactance regulator.

Fig. 3. (Right) Core shapes suitable for use in saturable reactors.



(a)

(b)

to a particular sample of transformer steel (Stalloy). For a given coil the ampere-turns will be proportional to the current. From the figure, it can be seen that at different points on the curve, equal increments in magnetizing current cause widely differing flux variations. In the case of a coil carrying a fixed alternating current

the required magnetic bias control.

It will be clear that the elementary design of the reactor core and windings shown in Fig. 2 has some obvious disadvantages. Normally, the d.c. control winding has a large number of turns and a high induced voltage will be developed in it. Alternating

Rectifier Voltage Control—

current will also flow in the control circuit. Core designs which eliminate these defects are shown in Fig. 3.

The type shown in Fig. 3 (a) is to be preferred since the leakage flux is small. Separate a.c. windings are placed on the two centre limbs, while the d.c. coil embraces the pair. By proper connection of the two a.c. windings, either in series or in parallel, it is possible to cancel the undesired induced voltage in the d.c. coil. With laminations of the type shown in Fig. 3 (b), the control winding is carried on the central limb and the two a.c. coils are wound on the outer cores. Again, care is necessary when joining the a.c. windings in series or in parallel, so as to avoid induced voltages in the d.c. coil. Several published papers give a discussion on the choice of core shapes. Making use of standard shell-type transformer laminations, the best scheme is to use two stacks of the form shown in Fig. 3 (b), assembling them with non-magnetic separators, winding the a.c. coils on the centre limbs and arranging the d.c. winding so as to encircle both central cores.

of about 15 per cent. This is particularly objectionable when sup-

ports of one regulated power unit:—

D.C. output voltage . .	970	985	995	1000	990
Load current (mA) . .	0	100	150	200	400

plying Class "B" modulators, and it is responsible for causing a large percentage of the total audio distortion. The circuit of Fig. 4 shows how complete compensation may be secured; in fact, it is possible to provide a rising characteristic so that there is an increase in output voltage consequent upon an increase in load current.

The action of the controlling reactor is as follows. Its a.c. windings are so proportioned that when the sole load on the rectifiers is the normal bleeder resistor (essential to prevent a dangerous rise in no-load voltage) the potential dropped across the reactor is 20-25 per cent of the supply voltage. The load and reactor voltages combine vectorially to give the supply voltage and under certain conditions, the first two voltages are approximately in phase quadrature. As soon as addi-

Particulars of the saturable reactor used in this case are given below:—

Lamination size (external = 5in × 4¼in.

Window area = 3in × 1½in.

Depth of stack = 1½in.

Cross-section of centre core = 1½in × 1½in.

The identical stacks are required to the above dimensions spaced by non-magnetic separators about 1in thick.

A.c. windings (2) each 300 turns, 18 s.w.g.

D.c. winding 1,200 turns, 24 s.w.g.

The general assembly and method of coil winding and connection are shown in Fig. 5. The construction of a similar unit was described by T. A. Ledward in *Wireless World*, June, 1943.

The performance figures given show that there is no difficulty in securing close voltage regulation using the circuit shown in Fig. 4. At the same time, it is necessary to keep in mind a number of factors which, under some circumstances, can prove objectionable. In the first place, non-linear devices using magnetic saturation must cause some waveform distortion. This effect is not serious in the present application. The high operating flux density necessarily increases the iron losses, but again, in this case, the requisite small change in controlled voltage permits operation at high efficiency, and the losses in the reactor vary with the output load. There is a relatively high stray field surrounding the saturable reactor, which must therefore be shielded magnetically or well spaced from low-level audio stages.

Returning to the question of waveform distortion, considerably different results are obtained in the two cases of series and parallel connection of the a.c. coils. In general, parallel connection is to be preferred, though in this case the response to load changes is rather more sluggish than for the

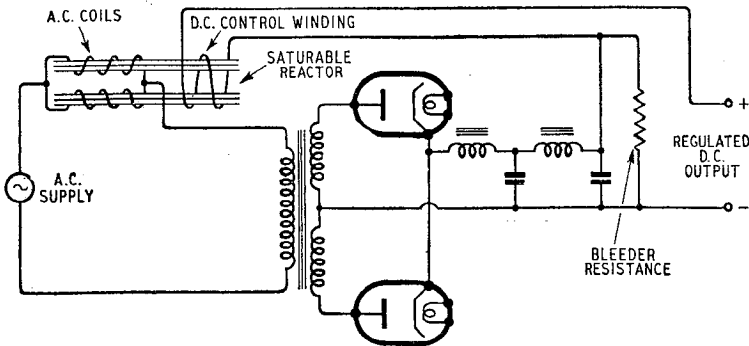

Fig. 4. Application of saturable reactor control in a mercury-vapour rectifier designed for feeding Class B modulators.

More details will be given later regarding winding particulars and core construction. Due to the many variables involved, it is difficult to give design information to cover a wide range of use. Instead, details will be given of one specific application.

A standard medium - power single-phase, full-wave mercury vapour rectifier set, using a choke-input filter, has a voltage regulation, between light and full load,

tional load current is demanded, a polarizing current flows in the d.c. winding of the reactor. There is a fall in its reactance and a change in its phase angle of impedance, so that there is a reduction in the voltage drop across it and a corresponding increase in the rectifier transformer primary voltage. The full d.c. output voltage is thus sustained or it may actually be increased. The following results were obtained during practical

alternative series connection. The response time is, of course, principally affected by the time constants of the smoothing filters, and no speeding-up of reactor response can do much to alter this characteristic. It is of advantage to increase the capacitance of the final filter capacitor as much as possible within economic limitations.

Since it is possible so to proportion the control reactor that there is a rising characteristic of output voltage versus load current, it might appear that there is some risk of a cumulative form of positive feed-back or over-

The control system described has applications in both radio and industrial electronic equipment, and for these purposes its reliability and extreme simplicity are in marked contrast with the complexity of alternative regulation systems, though its inherent limitations must be recognized.

REFERENCES

1. "Saturable Reactors for Load Control." P. A. Vance. (*General Electric Review*, August and September, 1947.)

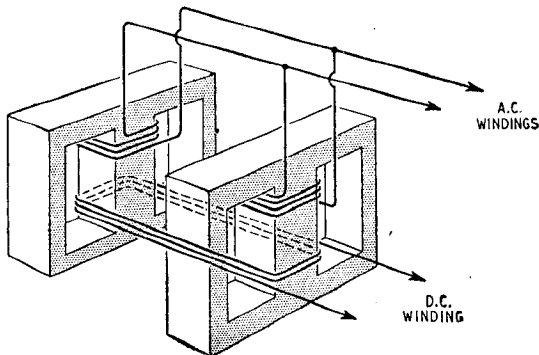

Fig. 5. Arrangement of cores and windings used in the reactor shown in Fig. 4.

control instability, but in practice, this is not experienced. At the same time, it must be recognized that the normal effects of supply voltage changes are enhanced, and if very high stability is essential, it may be necessary to supply the entire equipment from a constant-voltage transformer, though in most practical cases there is no need to go to this extreme.

2. "Magnetic Amplifiers." (*Electronics*, September, 1947.)
3. "Reactance Amplifiers." A. S. Fitzgerald. (*Electronics*, October, 1937.)
4. "U.H.F. Field-Strength Meters." E. Karplus. (*Electronics*, November, 1946.)
5. "F.M. by Non-linear Coils." L. R. Wrathall. (*Bell Laboratory Record*, March, 1946.)
6. "Voltage Regulators using Magnetic Saturation." K. J. Way. (*Electronics*, July, 1937.)

HIGH-QUALITY REPRODUCER

Details of the Vitavox "Klipschorn"

TO meet the demand of the connoisseur for a really high-grade reproducer capable of doing justice to recent advances in recording technique and amplifier design, Vitavox, Ltd., Westmoreland Road, London, N.W.9, have introduced a "corner cabinet" loudspeaker with many interesting features.

Two driving units are employed, a Type S2 pressure unit for frequencies above 500 c/s, and a special 15in cone for lower frequencies. Frequency division is effected in a single-section, series-connected, cross-over network.

Both units work into true horn loading and the bass horn is of complicated construction. It is of the folded re-entrant type with divided outlets emerging at the two sides of the cabinet. The walls of the room form an extension to the horn, and special provision is made to get

an air-tight seal between the cabinet and walls, which may not be perfectly flat or at exactly 90 deg. The internal divisions of the cabinet are all of 3/4in plywood, and great care is taken to ensure perfectly air-tight joints bonded with synthetic resin glue. The acoustic design is due to P. W. Klipsch,* and the exterior design is due to F. C. Ashford.

We have had an opportunity of hearing this reproducer on a wide variety of test records and radio programmes (f.m. and a.m.) and the outstanding impression is one of power and solidity. There seems to be an unlimited capacity for delivering acoustic watts without the slightest sug-

Vitavox high-quality reproducer based on the design of P. W. Klipsch.

gestion of wilting either in the driving units or the cabinet work, and the electro-acoustic efficiency is such that a 10-watt amplifier provides all the volume necessary, not only for the home but for, say, a gramophone recital to an audience of several hundred people.

The bass response is outstandingly good and there is no lack of top of a quality which does full justice to the brass section of the orchestra. We could detect no flaw in the transition at the cross-over frequency of 500 c/s.

For its size the "Klipschorn" gives a very impressive performance, and a power and depth of bass response that is usually found only in cinema reproducers. The cabinet stands approximately 4ft 2 1/2in high and extends 27 1/2in from the corner of the room. The whole instrument weighs 210 lb, and the price is £135.

* *J. Acous. Soc. Amer.*, Jan., 1946; *Electronics*, Feb., 1946.

NEW RADIO-GRAMPHONE

IN the design of the Murphy A138R radio-gramophone particular emphasis has been placed on the reproduction of gramophone records and a moving-coil pickup has been developed specially for use in conjunction with the automatic record changer. Two 6en44 valves in push-pull, with negative feedback, deliver 12 watts to two loudspeakers with diaphragms of 10in and 5in diameter.

The three-waveband radio receiver follows the conventional arrangement of frequency changer, i.f. amplifier, diode detector, and a.f. amplifier, but it is interesting to note that the earlier stages have their heaters fed in series from a mains auto-transformer.

An edge-lit Perspex tuning scale projecting from the front of the cabinet is a distinctive feature, and the whole of the front panel, carrying the receiver chassis and loudspeakers, hinges forward, giving accessibility for servicing.

The price, including purchase tax, is £62 8s 11d, and the makers are Murphy Radio, Welwyn Garden City, Herts.

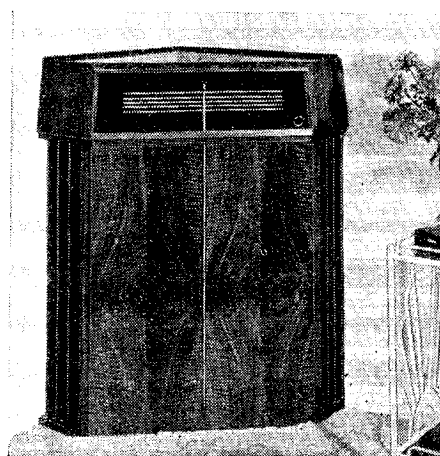

BLOCKING OSCILLATORS

Improving Performance at High Frequencies

By W. T. COCKING, M.I.E.E.

ON account of its simplicity and reliability the blocking oscillator is one of the most attractive circuits for generating saw-tooth waveforms or narrow pulses. It is by no means a new circuit for it was commonly employed in pre-war television sets and was very widely used during the war as a pulse generator and as a frequency divider in radar equipment. It is now almost the standard method of generating saw-tooth waves in television.

In spite of this, and of its apparent advantages for the purpose, the blocking oscillator is rarely used in oscilloscopes. Having searched the literature and found few references to this application, the writer decided to try it out, and it then soon became apparent why it is not often so used. Although not far from ideal at low and medium repetition frequencies, a serious fault made its appearance at high frequencies.

As no published reference to this defect could be found, the

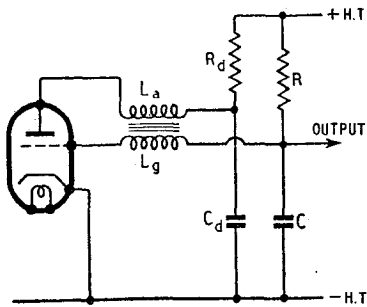

Fig. 1. The usual blocking-oscillator saw-tooth generator.

writer was led to investigate it in some detail. In its turn this led to the development of a more or less satisfactory remedy.

The usual blocking oscillator circuit is shown in Fig. 1; R_d and C_d are merely voltage-dropping and decoupling components. In all that follows it is assumed that C_d is so large that the voltage across it remains constant and

for ease of reference this voltage will be termed V_d .

The saw-tooth appears across C. When the valve is conductive C is charged by grid current and the output terminal goes very rapidly negative with respect to cathode. It reaches a maximum negative voltage V_c which is very approximately $V_d/3$ in magnitude.

When the valve is non-conductive C discharges through R until the voltage falls sufficiently for the valve to conduct again or until an external trigger pulse makes the valve conduct. If the h.t. supply voltage is V_{ht} the voltage acting in the discharge circuit is $V_{ht} - V_c$. As V_c is negative this voltage is greater than that of the h.t. supply.

In most, if not all, other circuits the capacitor is charged positively with respect to negative h.t. and so the initial voltage acting on discharge is less than that of the h.t. supply. This fact is one of the great advantages of the blocking oscillator, for the higher voltage acting in the discharge circuit means that the discharge is more linear. For a given supply voltage and saw-tooth amplitude, the blocking oscillator gives better linearity than other circuits.

This alone is, of course, far from being a decisive factor, for unless the output amplitude required is very small the linearity of even the blocking oscillator is not adequate for oscilloscope purposes. It is usually necessary to adopt one of the well-known linearizing circuits in any case.

The mode of operation of the blocking oscillator is very simple in principle but very complex in detail. It is easiest to start by supposing C to be so charged that the valve is beyond cut-off. This means that the upper plate (on the diagram) is negative with respect to the lower. The capacitance then discharges through R

and the voltage across it falls, so bringing the grid of the valve nearer to the cathode in potential. This goes on until the grid-cathode voltage falls within the grid base of the valve, which

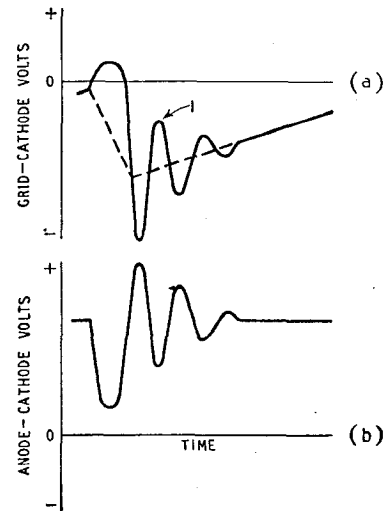

Fig. 2. Grid (a) and anode (b) voltage waveforms in the circuit of Fig. 1 when the transformer losses are only moderate.

then starts to draw anode current. This produces a back-e.m.f. in L_a in a direction to oppose the current and the anode voltage of the valve falls.

A similar e.m.f. appears by induction in L_g . Its magnitude is modified by the turns ratio but, in practice, this is usually 1:1. The transformer is so poled that this secondary e.m.f. acts to drive the grid in a positive direction and it consequently results in an increase of anode current. This in turn drops the anode voltage further and results in the grid becoming more positive, still further increasing the anode current. It is a regenerative action.

In an exceedingly short space of time the grid-cathode voltage falls enough for grid current to start. This flows through L_g and

produces a back-e.m.f. in opposition to that induced from L_a . However, the latter greatly predominates and the main action is carried on, the grid being carried well positive to cathode and the anode voltage falling to a low figure.

The grid current flows into C to recharge it. The voltage across C increases rapidly in a negative direction, the output terminal being carried well below cathode potential. The voltages across L_a and L_g are equal with a 1:1 ratio transformer. The grid is positive with respect to cathode by this voltage less that across C, and the anode-cathode voltage is V_a less the transformer voltage.

After a time the rate of change of anode current decreases, so reducing the e.m.f. in L_a and hence that in L_g . The grid voltage rises less and so further reduces the anode current rise. Again the effect is cumulative and the valve is rapidly cut off, the voltage in the transformer disappears and the circuit is left quiescent with C charged. Nothing further happens except for the slow discharge of C through R until the voltage across C falls sufficiently to initiate the whole cycle again.

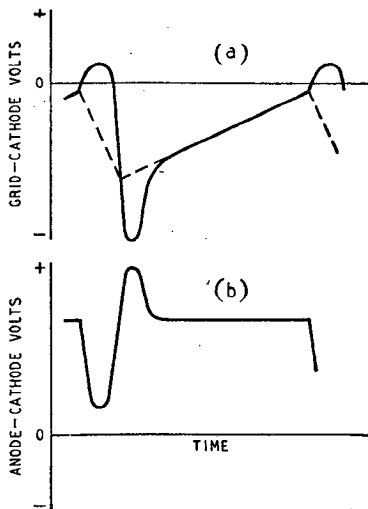

Fig. 3. Grid (a) and anode (b) voltage waveforms with heavy transformer losses. The dotted curve shows the voltage across C.

However, this account of the operation of the circuit is really over-simplified. The various stray

capacitances have an important effect and instead of L_a and L_g forming the windings of an ideal transformer they really form the inductance of a Hartley oscillator.

An equivalent circuit showing

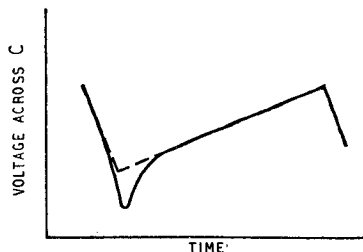

Fig. 4. The solid line shows the wave actually obtained across C when its capacitance is small and the dotted line indicates the required wave.

the stray capacitances appears in Fig. 5. In addition to the valve capacitances there are the winding capacitances C_a and C_g and the inter-winding capacitance C_1 . The main effect of these capacitances is to cause oscillatory voltages to appear across, and oscillatory currents to appear in, L_a and L_g when the valve is cut off.

Instead of the voltages in the inductances disappearing quickly when the valve is cut off they execute damped oscillations. The grid voltage swings below the voltage on C and the anode swings above the supply voltage. These voltages have the form shown rather exaggerated in Fig. 3. The voltage on C has, or should have, the form shown dotted in (a).

For proper operation under these conditions it is essential that the first positive half-cycle after the valve is cut off should not be of sufficient amplitude to bring the valve within its grid base. Point 1 in Fig. 2(a) must not rise above the cut-off voltage of the valve. If it does it will restart the regenerative action of the valve and the stage will operate as a class C "sine-wave" oscillator and will not block.

The effect is avoided by making the resonant circuit of low Q. This is usually done by using an iron-cored component with fairly heavy core losses but, if necessary, a damping resistance can be

New
TRIX
Quality
SOUND EQUIPMENT

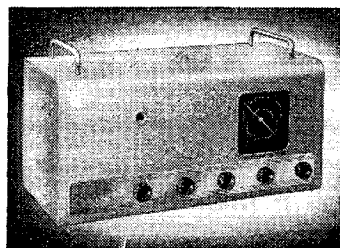

Model RA101
-for SCHOOL
BROADCASTING

and small installations in Hotels, Clubs, Factories, etc.

This new model has been designed to meet the demands of Educational authorities and other users for broadcasting installations giving high quality reproduction.

The complete unit is mounted in a well finished grey metal case, with chromium handles. It incorporates the radio receiver unit, superhet type, covering three wavebands, together with amplifier unit giving fully 12 watts undistorted output. Individual tone control circuits for Bass and Treble boost are incorporated. In order to ensure correct tuning, the radio unit is fitted with a Magic Eye tuning indicator, making a total of 9 valves.

Inputs are also provided for the addition of a gramophone turntable unit or a microphone, and adequate gain is provided for this purpose. The output circuit is high impedance, allowing a number of external speakers to be attached on long lines, without loss of power.

Send for full details of this and other Trix Quality Sound Equipment

THE TRIX ELECTRICAL CO. LTD.
1-5 Maple Place, Tottenham Court Road, London, W.1. Phone: MUSeum 5817.
Grams & Cables: "Trixa'do", Wesdo, London."

AMPLIFIERS - MICROPHONES - LOUDSPEAKERS

Blocking Oscillators—

connected across a winding. In practice with the proper damping the waveforms are more like

the grid negative; that is, point *a* is going positive with respect to *b* and *f* is going negative with respect to *d*. The current in the inductances, therefore, must be an electron current flowing upwards and increasing with time. It flows through L_g in the same direction as the grid current. The current oscillates so that it is proportional to the integral of the voltage across the inductance; that is, if the voltage is roughly sinusoidal, the current is roughly cosinusoidal.

It is important to notice that this oscillatory current in the circuit persists after the grid current has ceased and the valve has been cut off. It lasts as long as the anode and grid oscillations of voltage shown in Figs. 2 and 3 persist and in

Conditions during fly-back are largely independent of C ; they are governed mainly by the transformer characteristics and stray capacitances. As long as this is true the oscillatory current in C is independent of its capacitance but the voltage which it develops across C is inversely proportional to its capacitance. When C approaches the stray capacitances in magnitude its value does affect the fly-back and the current, but the oscillatory voltage across it is then very large.

There appears to be no way of avoiding the effect with this form of blocking oscillator. However, there are other forms of the circuit. One modified form is shown in Fig. 6. It functions in much the same way as the other circuit, but is modified somewhat by negative feedback from the cathode inductance. Since C is no longer included within the oscillatory circuit it would at first appear that the circuit would be free from the overshoot in the voltage across C . In practice it is not. The overshoot is still present.

When the circuit is examined in more detail, however, it can be seen that C is actually coupled to the tuned circuit by the grid-anode and grid-cathode valve capacitances and so a part of the oscillatory current must flow in C . In order to prove this the experiment was tried of operating at a low recurrence frequency with a large value of C . Overshoot was unobservable. The grid-anode capacitance was then artificially increased by adding external capacitance and the overshoot then appeared as expected.

The advantage of this circuit over the earlier one is that it

those of Fig. 3 than those of Fig. 2.

It is observed in practice that at low recurrence frequencies the voltage wave across C really has the dotted form of Fig. 3(a) except that the fly-back is so rapid that it appears vertical. As the frequency is increased by reducing C , however, an overshoot appears at the end of the fly-back. In the writer's experience this becomes detectable when C is reduced to $0.01\mu F$ but is small enough to be unimportant. With smaller values it becomes more prominent and when it is $100 pF$ the overshoot may equal the scan amplitude. In addition, the overshoot persists well after the nominal end of fly-back and so occupies a good deal of time which should be devoted to a linear sweep. The form of the wave is sketched in Fig. 4 in which the desired wave is shown dotted.

The overshoot arises because C forms part of the oscillatory circuit. It has been shown in Figs. 2 and 3 that there are voltages of oscillatory form across the inductances during and immediately after the fly-back. Now if there is an oscillatory voltage across an inductance there must be an oscillatory current in it and there must be a closed path in which that current can flow. The closed path is provided by the stray capacitances and these are shown in Fig. 5, which is Fig. 1 with the capacitances added.

When the valve is cutting off, the anode is going positive and

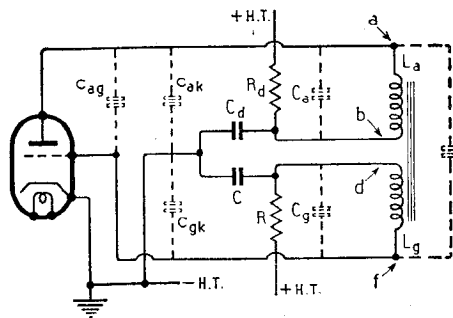

Fig. 5. Blocking oscillator circuit with the stray capacitances added.

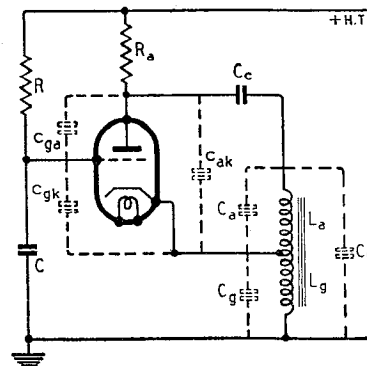
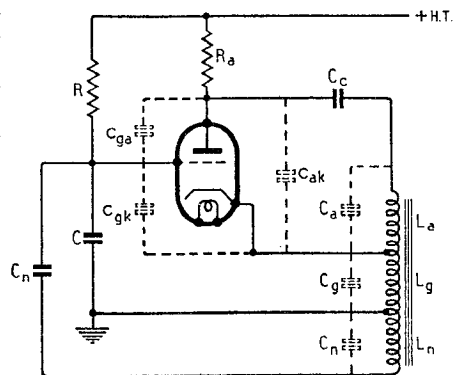

Fig. 6. Cathode-tapped blocking-oscillator circuit.

high-frequency operation they can last for at least half the sweep period.

Inspection of Fig. 5 shows clearly that except for a relatively small part in C_a and C_g the whole of this current flows through C . The closed circuit is L_a , C_d , C , L_g and the combined value of C_1 , C_{ag} , C_{gk} , C_{ak} . The mutual inductance between L_a and L_g complicates the matter somewhat but does not affect the main conclusion.

Fig. 7. Basic form of the cathode-tapped circuit with neutralizing components L_n and C_n added.



lends itself to a method of overcoming the defect. If an additional winding L_n and capacitance C_n are added, Fig. 7, the coupling through the valve capacitances can be neutralized. C_n is connected to a point which undergoes voltage variations in opposite phase to those of the grid and cathode. The current through it is then in opposition to those through c_{ga}

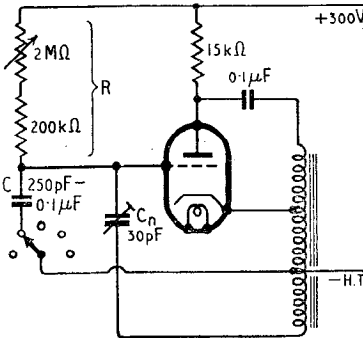

Fig. 8. Practical form of neutralized cathode-tapped blocking oscillator. The valve can be one section of a 6SN7.

and c_{gk} and can be adjusted to equal their sum.

One can then consider the currents in c_{ga} and c_{gk} as returning to the tuned circuit through C_n and so missing C completely. Alternatively one can regard the valve capacitance currents in C

as being cancelled by an equal and opposite current in C from C_n .

If L_a , L_g and L_n all have equal turns and are very tightly coupled so that the leakage inductance is negligible, it is easy to work out the required value of C_n . The first step is to resolve c_{ga} and c_{gk} into a single equivalent capacitance. Since $L_a = L_g$ the anode voltage swing is twice that of the cathode and so c_{ga} can be regarded as absent if c_{gk} has added to it a capacitance $2c_{ga}$. Then neutralization is complete if C_n equals this effective grid-cathode capacitance; that is $C_n = c_{gk} + 2c_{ga}$.

In its practical form the circuit is shown in Fig. 8 and it is convenient to make C_n a 30-pF trimmer. The value to which it is actually set is of the order of 15 pF. It should be adjusted at the highest sweep frequency for the most linear sweep as observed on an oscilloscope and the setting is moderately critical.

It is not, of course, practicable to obtain perfect neutralization, for the inevitable leakage inductance of the transformer prevents this. It is however, possible to reduce an overshoot of 50 per cent to perhaps 2 or 3 per cent only and so to turn an unusable saw-tooth into one which is quite adequate for many purposes. The main practical drawback lies in the need for an oscilloscope in order to carry out the neutralizing adjustment.

NEW BOOK

Television. By M. G. Scroggie, B.Sc., A.M.I.E.E. 2nd edition. Pp. 77+ix, with 28 illustrations. Blackie & Sons, Ltd., 17, Stanhope St., Glasgow, C.4. Price 6s.

THIS book gives a very simple and lucid explanation of how television works. Originally written in 1935, this post-war edition has been very thoroughly revised.

In his first chapter the author explains what is involved in television. He shows why a scanning process is necessary and in turn why this involves high frequencies. In the next chapter he goes on to describe briefly some of the methods by which television has been attempted, and in Chapter III he turns to the cathode-ray tube as applied to television, and good elementary descriptions are included.

Subsequent chapters deal with television standards and present-day

transmitters and receivers, while broadcasting technique and future developments receive some attention.

The book covers the whole field of television in only 77 pages, so that details of methods and equipment are necessarily scanty. It is not intended to supply such detail, however, for the book is really an introduction to television and meant for those who know nothing about it. The author claims also that: "Although some knowledge of radio will help here and there, the reader with only a general interest in modern invention should be able to follow all the essentials." In the reviewer's opinion a little more prior knowledge of radio than this is needed, but there is no doubt that, given this rather elementary knowledge, the book does form an excellent introduction to television.

W. T. C.

M. WILSON LTD

"White Rose Radio"

In order to meet the demand for something not expensive yet good, Mr. Wilson has designed two new units.

A 4-stage H.F. UNIT

covering the medium and long waves only, but with exceptionally good fidelity, incorporating our new wide-band superhet circuit, with infinite impedance detector. If you have a few minutes to spare, will you please visit our shop and hear for yourself.

We will also demonstrate our new low cost **GRAMOPHONE AMPLIFIER** with triode output.

In producing these inexpensive units, no sacrifice of quality for cheapness has been allowed. Sound design, plus 100 per cent. good workmanship, together with quality components, have been combined to give the best possible at the lowest cost. Wherever you reside in England, Scotland, Ireland or Wales, you will receive the B.B.C. transmissions with power and quality of reproduction.

Prices:

H.F. Radio Unit £9 18 0
plus Purchase Tax
Gramophone Unit £8 10 0

Still giving satisfaction in five continents. Our well-tested, world-renowned

CIRCUIT No. 20

A 10-valve superheterodyne circuit with R.F. stage, six wave-bands, 5-2,000 metres, push-pull output for radio and gramophone. Full specification for those interested. Two full-size practical and one theoretical blue prints, and priced list of parts. Price 7s. 6d. per set.

Another satisfactory circuit,

6-VALVE SUPERHETERODYNE CIRCUIT (including rectifier and tuning eye).

A.C. only. Three wave-bands, long, medium and short waves. Two full-size practical and one theoretical blue prints and priced list of parts. Price 6s. If all components for the above receivers are purchased from us, the price of the blue prints will be refunded.

We guarantee full satisfaction if all our components, good workmanship and adherence to layout are followed.

Now in stock,

our new iron-cored permeability tuned Litz wound 465 Kc. Variable selectivity I.F. transformers with a "Q" of 155.

Blue print supplied with each pair of coils, showing various methods of obtaining varying band widths and selectivity. Price 22s. 6d. per pair.

Our SIX WAVE-BAND COIL UNIT, 5-2,000 metres, completely wired up, as used on our No. 20 circuit, and 6-wave H.F. Unit advertised last month. Price wired up, calibrated to our 6-wave-band dial, and tested, £8 2s. 6d., including purchase tax. Complete in every detail, in kit form, together with the necessary blue print. Price £5 10s.

NEW T.R.F. CIRCUIT, 2 R.F. stages, local stations receiver, infinite impedance detector, L.F. stage, cathode coupled to two output triodes in push-pull with negative feedback.

A receiver with extremely good high-fidelity output on gramophone. Two full-size practical and one theoretical blue prints and priced list of parts. Price 7s. 6d. Where local conditions are very poor, we strongly advise our superheterodyne circuit, and shall be pleased to advise you upon the choice of circuit suitable for your locality.

307, HIGH HOLBORN,
LONDON W.C.1. Phone: HOLborn 4631

Unbiased

By FREE GRID

Mr. Punch Nods with Homer

ONE of the weaknesses of the flesh to which we are all heir is the taking of a sadistic delight in saying "I told you so" whenever opportunity offers. The temptation to say this gathers strength in proportion to the eminence of the person to whom we are able to say it. This desire becomes so overmastering that we yield to it regardless of all consequences and despite all the warnings of prudence and common sense. A notable instance of this was Cardinal Wolsey's fatal inability to refrain from reminding Henry VIII that he had anticipated by several months the Royal remarks about Anne Boleyn's behaviour. The result of this, of course, was a regrettable gap in the ranks of the Freemen of Ipswich, although actually kindly nature mercifully forestalled Henry.

Therefore, even at the risk of a vacant chair among the Burgesses and Aldermen of my own city, I cannot refrain from pointing out to Mr. Punch his unconscious plagiarism. He reminds householders struggling to keep up appearances that a licence is not necessary for just a television aerial (13.4.49). It is just ten years ago that I gave a full account in the pages of this journal (8.6.39) of the doings of the new "snobocracy." Mindful of their poverty, and at the same time of the necessity of keeping up what the late Sir Arthur Quiller-Couch called "Cumeelfo," the "snobo-

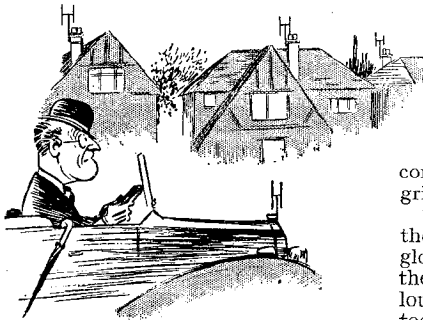

Aerials Without Portfolio.

crats" have erected on their chimney-stacks what are best described as television aerials without portfolio.

As Mr. Punch has so belatedly

discovered, this pernicious practice is still going on; in my opinion pernicious is undoubtedly the *mot juste* to use in spite of the fact that the king of laughter makers takes a more kindly view of the practice than myself, and sees behind it the more worthy motive of keeping up appearances.

I am happy to record that Mr. Punch makes no claims that his discovery is an original one; which is more than can be said of certain inventors. I would go so far as to say that there are few major inventions in the realm of radio and electronics which have not been anticipated in these columns; in fact, many large corporations are jealously guarding patents which would be rendered quite worthless were I minded to drop a line to the Comptroller of the Patent Office calling his attention to my prior publication.

Were it not against my principles I could, without doubt, make a considerable income by accepting under-the-counter royalties from these firms. Moreover, it could be free of income tax, as they would most certainly not risk offending me by notifying the Inspector.

Midsummer Menace

DURING the murky days of "drear December," as we sat round the electric fire which Mr. Gaitskell had cut off, and drew our overcoats and the encircling gloom of our own thoughts a little more closely around us and solemnly munched a benzedrine tablet to raise our blood pressure, we not unnaturally indulged in escapist thoughts. We sighed for the long, lovely and languorous summer days which lay ahead when our tired and sweat-soaked bodies will straphang twenty-to-the-compartment on our annual pilgrimage to the sea.

This year, alas, such comforting thoughts failed to cheer my winter gloom, for I have been faced with the fearful menace of the over-loud loudspeaker bellowing through the too-open window. My only weapon of counter-offensive appears to be useless, its sting having been drawn by a callous government, aided and abetted by the opposition, by means of the new "anti-interference" Bill.

Hitherto I have been able to secure some measure of peace in

my neighbourhood by letting Mrs. Free Grid run amok with her so-called violet-ray beautifier. With this aid she endeavours, will-o'-the-wisp fashion, to recapture the pristine glamour that was hers when she made her *debutante* bow before Queen Victoria in the days when



Not Dingley Dell.

knights were bolder and nights were kinder than nowadays, when the gentle glow of Queen Spermaceti has given place to the harsh glare of King Neon.

I have been hard put to it to evolve a legally permissible way of getting round the "anti-interference" Bill, for to break the law deliberately would be abhorrent to me. I have, I think, solved the problem, but my legal learning is admittedly not in the K.C. class, and I shall feel very gratified if any of your Portias of either sex can point out the flaws, if any, in my scheme, and, moreover, suggest remedies.

Briefly, I have fitted Mrs. Free Grid's beautifier with all the suppressors which the law requires, but have, in addition, fitted a relay which, on being actuated, switches them out of circuit. This relay is operated from a suitable amplifier which is controlled by microphones placed at strategic points round my garden wall so that offending loudspeakers themselves trigger-off the reprisals; it is, in fact, a sort of inverted I.F.F. or Vogad circuit. The owner of the offending loudspeaker is himself (more usually herself) morally responsible for causing the interference, and it is my firm belief that in a test case he, or she, would be held legally liable and be quite justly fined for the offence.

Fiat justitia.

LETTERS TO THE EDITOR

Economics of Interference Suppression ♦ Simple E.H.T. Supply ♦ Television Lines and Picture Quality ♦ Time-base Circuit Characteristics

Interference versus Signal

IT occurs to me that economically the proposed legislation for the compulsory suppression of electrical interference is in a sense unsound. The total cost, I would imagine, will considerably exceed the amount required to provide greater signal strength (voltage at aerial) by increasing the number of transmitters and/or their radiated power. In any event, as you have pointed out, there are types of interference which it will be most difficult to suppress. Great Yarmouth. S. WEST.

E.H.T. for VCR97 Tubes

THE accompanying diagram shows how a 2-kV supply may be obtained from a standard 350-0-350 mains transformer, which is at the same time providing normal h.t. The principle is that of the "Westeht" unit, fully described in your May, 1948, issue. I am using the method with a 400-0-400 transformer, with the VCR97 in an oscilloscope. The e.h.t. peak value is then 2.4 kV. The rectifiers used are Westinghouse J50 (two) and J100—available cheaply on surplus market. The tube filament is best supplied from one of the filament windings via

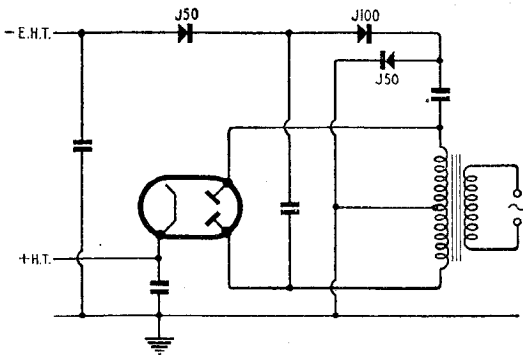

an isolating transformer which may easily be wound by hand on an old output transformer core.

C. J. MCCUBBIN.

Cambridge.

"Television Goodness Factor"

IN the above article (your March issue) the writer claims that there is no advantage to be gained from an increase in the number of lines above 405 until the trans-

mitting, relaying and receiving equipment are all capable of handling a 5-Mc/s bandwidth. I fail to agree with this.

When calculating f_{min} to give equality in horizontal and vertical definition one should use a utilization factor. All the elements of the object being scanned do not coincide with a scanning line, and so some of the picture elements are distorted or missing; this reduces the effective number of scanning lines. Utilization factors of between 0.6 and 0.95 have been suggested and D.G. Fink puts 0.75 "as a convenient basis for calculation." Hence, for the present B.B.C. system:

$$f_{min} = \frac{405^2 \times 25 \times 5 \times 93 \times .75}{2 \times 4 \times 84.5} = 2.12 \text{ Mc/s.}$$

$$\text{And so } D = \frac{f_{mod}}{f_{min}} = \frac{2.7}{2.12} = 1.27$$

$$\text{Also for } D_{opt} = 1.5; f_{mod} = 1.5 f_{min} = 3.18 \text{ Mc/s.}$$

In a system with 525 lines, 25 pictures/sec., 5:4 aspect ratio, 94 per cent. vertical and 84 per cent. horizontal activity and a utilization factor of 0.75

$$f_{min} = \frac{525^2 \times 25 \times 5 \times 94 \times .75}{2 \times 4 \times 84} = 3.62 \text{ Mc/s.}$$

$$\therefore \text{ for } D_{opt} = 1.5; f_{mod} = 1.5 f_{min} = 5.43 \text{ Mc/s.}$$

From this it can be seen that with the present B.B.C. system any increase in transmitted bandwidth beyond 3.18 Mc/s, while giving an improvement, will not give optimum conditions if unaccompanied by an increase in the number of lines. Also the 5-Mc/s

bandwidth suggested by R. W. Hallows would give a d.f. of 1.38 on a 525-line system.

I should also like to point out what I believe to be an error in Fig. 2 in the same article. Three peak blacks and two peak whites occur at (a) represented in the voltage waveform by three peak negatives and two peak positives at (b). However (c), the reproduction on the screen, shows five peak blacks and four peak whites. The second and fourth blacks should,

THE TYPE 'A'

Antiference Outlet Box

COMPLETES THE CIRCUIT
AND
PROVIDES SIGNAL ATTENUATION . . .

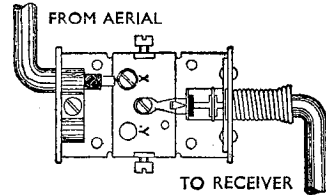
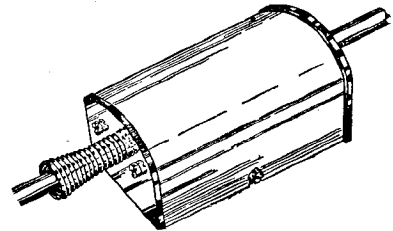

A range of three Outlet Boxes suitable for either single point domestic terminations or multi-point installation wiring. Once and for all are ended, make-shift hook-up methods. With these Outlet Boxes a selection of attenuator units of various values is also available. The Outlet Box is of aluminium alloy with a neutral anodized finish, size, 2 3/8" x 1 3/8" x 1 3/8" overall and all models are supplied complete with co-axial switch.

The Antiference Outlet Box, Type "A" (illustrated) incorporates a self contained signal attenuator to suit individual needs—three values are available to provide 10:1 3:1 or 1:81 reduction. No soldering is required to fit or exchange a unit—it slips into position assuring perfect contact always. List price 7/9

The Antiference Outlet Box, Type "D" incorporates a distribution unit enabling a number of receivers to be supplied from one aerial where high signal strength is available or an aerial amplifier is used. List price 7/9

The Antiference Outlet Box, Type "S" provides a neat and convenient arrangement for terminating single point television installations. List price 4/9

ANTIFERENCE LIMITED
67 BRYANSTON ST., LONDON, W.1

Letters to the Editor—

I believe, be whites. [Yes, this error is regretted.—ED.]

DENIS E. URRY.

London, S.E.23.

Time-base Circuit

IN his note on a time-base circuit in the May issue of *Wireless World*, J. McG. Sowerby does not refer to one of its characteristics which may well make it unsuitable for some purposes. The saw-tooth is preceded by a spike of considerable amplitude. With small values of capacitance, this spike merges into the saw-tooth and causes serious non-linearity at its start.

The accompanying table shows the effects of varying the capacitance.

With large capacitance values, corresponding to low repetition frequencies, the fly-back is very rapid

circuit, having the great practical merit of being exceptionally easy to put into operation. As both sweep

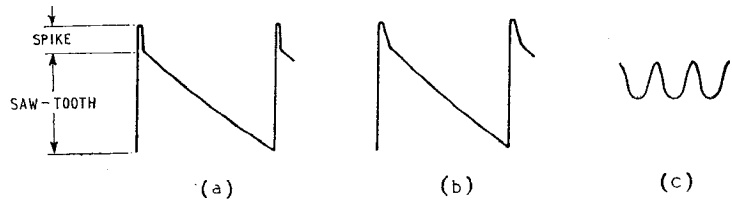

and the spike is accordingly very narrow: With small capacitances, however, the waveform changes from the form (a) to (b), while the anode waveform deteriorates from a very narrow pulse to something approaching a sine wave (c).

and fly-back times are controlled by the same capacitance there is almost nothing to go wrong.

It is, perhaps, worth pointing out also that the peak cathode voltage may, and usually will, greatly exceed the peak-to-peak-amplitude of the waveform, because the fly-back starts long before the capacitor is fully discharged. This must be taken into account when choosing the operating conditions, otherwise the heater-to-cathode voltage rating of the valve may be exceeded.

W. T. COCKING.

Capacitance	Saw-tooth Amplitude (V p-p)	Spike Amplitude (V p-p)	Per cent. Overshoot	Anode Pulse (V p-p)
100pF	17.6	3	17	6.5
0.01 μ F	23.4	4.15	17.8	26.6
0.1 μ F	23.4	4.15	17.8	26.6

They are for a 6SN7 double-triode with a 200-V h.t. supply and operating with a 1-k Ω cathode resistor for one valve and a 2-M Ω for the other, the anode coupling resistor being 15 k Ω .

The spike is, of course, inherent and brought about by the charging current in the cathode resistor on fly-back. Its presence is most unfortunate, because it mars what would otherwise be a most excellent

Drawing Circuit Diagrams

I WISH to endorse the remarks in his article on the above subject by L. H. Bainbridge-Bell in the May issue of *Wireless World*. I am more used to the conventions he prefers and whilst I have no difficulty in understanding bridged cross-overs, I am often confused by the use of cross-over connections.

I would like *Wireless World* to consider abandoning cross-over connections in favour of staggered connections, but still retaining bridged cross-overs. This action would render diagrams easily understood by people used to both sets of conventions.

J. I. COLLINGS.

Broadstone, Dorset.

Hum in High-gain Amplifiers

WHEN experimenting with high-gain amplifiers I have found "hum" to be reduced considerably if the "earth" connection is made through a capacitor of value 0.005 μ F, but when larger or smaller capacities or direct earth connections are used they have increased the hum. Alternatively, connection through a variable resistor of 0/250,000 Ω has given a very sharp "dead spot." I should be interested to know if other readers have found this effect. I have my own theories, but would be glad to know the exact reason.

I have never seen this mentioned in print, but perhaps it has missed my attention.

GEOFFREY P. DENNY.

Worthing.

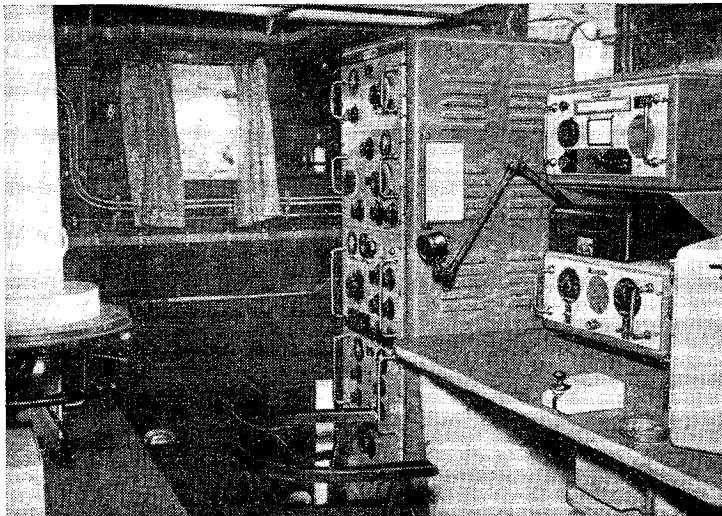
TRAWLER RADIO

DESIGNED specifically to meet the requirements of trawler owners and skippers, this new "Redifon" equipment, installed in the trawler *Thuringia*, has a working range on telephony of the order of 1,000 miles. Facilities for simplex, duplex or voice-operated relay working are provided. A special direction-finding equipment enables "snap fixes" to an accuracy of 1° to be taken on transitory speech code messages of only a few syllables. The makers are Redifusion Ltd., Broomhill Road, London, S.W.18.

SHORT-WAVE CONDITIONS

April in Retrospect : Forecast for June

By T. W. BENNINGTON and L. J. PRECHNER (Engineering Division, B.B.C.)

DURING April, maximum usable frequencies for this latitude decreased considerably by day, and increased somewhat at night. Thus the 28-Mc/s band in the last two weeks was no longer always reliable for daytime eastward and westward communication during the second half of the month. These are normal seasonal variations, and a similar trend should continue towards midsummer.

The month was somewhat less disturbed than March, ionosphere storms being observed on 5th-6th, 8th-9th, 11th, 13th, 19th, 22nd, 26th-27th and 29th-30th. The 8th-9th was exceptionally disturbed.

Apart from the disturbed period early in the month, conditions were on the whole very good on most circuits. 50-Mc/s amateur transmissions from South Africa were again received in England on a number of occasions early in the month. During the night frequencies of the order of 11 Mc/s continued to be workable.

The rate of incidence of Sporadic E was about the same as in March, and it was of the usual order for this time of the year.

Eight "Dellinger" fadeouts were recorded in April (three on 5th, one on 10th, one on 11th, two on 13th and one on 26th). Two fadeouts on the 5th were particularly violent.

Sunspot activity in April was somewhat less than in March. Only one large group crossed the central meridian of the sun (on 16th), and it was very probably associated with severe reception disturbances which occurred before that period.

Owing to the favourable weather conditions, long-range tropospheric propagation was observed on a number of occasions, particularly towards the end of the month.

Forecast.—During June the daytime m.u.f.s should continue to decrease, and may probably reach their annual minimum values. On the other hand, night-time m.u.f.s will continue to increase, probably reaching their highest values for the year.

Although daytime communication on very high frequencies (like the 28-Mc/s band) is not likely to be very frequent, over many circuits fairly high frequencies like 15 and 17 Mc/s will remain regularly usable until midnight. During the night frequencies lower than 11 Mc/s will be seldom required.

For medium distances up to about

1,800 miles the E and the F₁ layers will control transmission for considerable periods during the day, and in such cases daytime as well as night-time frequencies should be higher than in May.

Sporadic E is usually very prevalent in June, and communication over distances up to 1,400 miles may be possible by way of this medium on frequencies greatly in excess on the m.u.f.s for the regular E and F layers. Frequencies as high as 60 Mc/s may be occasionally reached for a short time. However, it is impossible to predict when such communication may occur, owing to the irregular behaviour of Sporadic E.

Below are given, in terms of the broadcast bands, the working frequencies which should be regularly usable during June for four long-distance circuits, running in different directions from this country. (All times G.M.T.) In addition, a figure in brackets indicates the highest frequency likely to be usable for about 25 per cent of the time during the month, for communication by way of the regular layers:—

Montreal :	0000	15Mc/s	(19Mc/s)
	0100	11 "	(15 "
	1200	15 "	(10 "
Buenos Aires :	0000	17Mc/s	(22Mc/s)
	0100	15 "	(19 "
	0500	11 "	(16 "
	1000	17 "	(23 "
	1500	21 "	(26 "
Cape Town :	0000	15Mc/s	(20Mc/s)
	0100	11 "	(15 "
	0500	17 "	(24 "
	0800	21 "	(28 "
	1800	17 "	(22 "
Chungking :	0000	11Mc/s	(14Mc/s)
	0500	15 "	(20 "
	2300	11 "	(14 "

Ionospheric storms are not very common in June, and relatively undisturbed conditions may be expected. At the time of writing it would appear that storms are more likely to occur during the periods 2nd-5th, 8th-10th and 28th-30th, than on the other days of the month.

MORE LOUDSPEAKERS

THE new range of Plessey loudspeakers has been further extended by the provision of alternative magnet assemblies in the 6in and 8in models; thus manufacturers can avail themselves of higher sensitivity and damping where this is particularly required. All p.m. speakers with the exception of the 3-in model are now available with 3-ohm as well as 5-ohm voice coils.

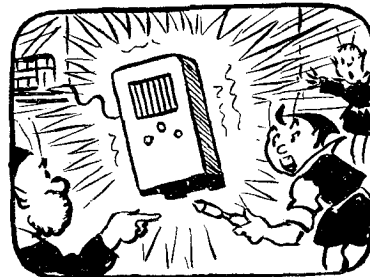

THE "FLUXITE QUINS" AT WORK

"When soldering an aerial, son,
With FLUXITE, make sure when you've done
And you've got it all fixed
That it hasn't got mixed
With a trolley bus wire! It's no fun!"

See that FLUXITE is always by you—in the house—garage—workshop—wherever speedy soldering is needed. Used for over 40 years in Government works and by leading engineers and manufacturers. Of all Ironmongers—in tins, 10d., 1/6 & 3/-.

TO CYCLISTS! Your wheels will NOT keep round and true unless the spokes are tied with fine wire at the crossings AND SOLDERED. This makes a much stronger wheel. It's simple—with FLUXITE—but IMPORTANT.

The FLUXITE GUN puts FLUXITE where you want it by a simple pressure. Price 2/6, or filled, 3/6.



ALL MECHANICS WILL HAVE

FLUXITE

IT SIMPLIFIES ALL SOLDERING

Write for Book on the ART OF "SOFT" SOLDERING and for Leaflets on CASE-HARDENING STEEL and TEMPERING TOOLS with FLUXITE. Price 1d. each.

FLUXITE LTD.

(Dept. W.W.), Bermondsey Street, S.E.1

RANDOM RADIATIONS

By "DIALLIST"

Fringe-area Television

IN LAST MONTH'S ISSUE of *Wireless World*, W. Gearing-Sherratt asked why our makers of television aeriels have not done more to develop multi-element arrays, designed to make the most of weak signals at distances of 100-150 miles from the transmitting station. He states correctly that any American radio magazine contains numbers of advertisements of high-gain three-element or four-element arrays of folded dipoles markedly directional and of very high performance. He laments the absence of similar arrays from the advertisement pages of our wireless magazines. A short time ago this was true; but now more than one firm of manufacturers caters for fringe-area television reception. There's no question that if you put up a receiving aerial array, strongly directional and of very high gain, you can receive television broadcasts far beyond their normal range. One of the most convincing proofs of this was the success of the array erected on Beachy Head during the war to receive television from Paris. The Germans kept the Paris transmissions going after the occupation and used them for propaganda purposes. The big idea was to broadcast to the French populace horror pictures of the damage wrought by allied bombers in the attacks that they had to make on French factories engaged in turning out war material for our enemies. As there were then not more than a few hundred receivers in use in the Paris area, this object was not attained. But a high-gain aerial array erected on the cliffs near Dover enabled these broadcasts to be received by our people and gave them invaluable up-to-the-minute information. The demand for multiple aerial arrays is likely to grow rather than to decrease as new transmitters come into operation and interest is widespread.

For the Soldering Iron

EVERYBODY, I SUPPOSE, who uses an electric soldering iron makes (or is always promising himself that he will make, one of these days) some kind of prop, enabling the hot iron to be put down anywhere on bench

or table without the risk of "frying" valuable bits and pieces. I've never been quite satisfied with any of my own contraptions and have for long been intending to make something of superlative excellence. One somehow never seemed to find time to do the job; but the other day I had, like friend Murdoch, an idea, which I pass on for the benefit of any who are as good at putting things off as I am. Cost, three-pence or fourpence; time required, about the same number of minutes; performance, eminently satisfactory. You know those paper clips (Bulldog, I think they're called) which open a pair of jaws when you squeeze a couple of lugs sticking out at the top? Get a small one of those; mine has $1\frac{1}{4}$ -inch jaws. If need be, shape the jaws with a pair of pliers. Then slip it on to the body of the iron about 4 inches above the tip of the bit and bend the lugs outwards to form "feet." This prop stays put, doesn't get in the way and doesn't upset the balance of the iron. What's wrong with ready fitted props or feet?

Big Business

USED AS PACKING in a parcel which I received a short while ago from the U.S.A., came a copy of an

American "tabloid" illustrated daily newspaper. Having almost forgotten what even our dailies used to be in days gone by, I examined it with awe, amazement and a modicum of regret. Seventy-two pages; price two cents! My regrets were occasioned by the reflection that each page of this not very valuable publication was about four times the size of those of an average book; hence each issue contains enough paper to make a 288-page book. It seems a queer business that at a time when one part of the world is so short of paper that it can't supply students with sufficient text books, either new or reprinted, another part should think nothing of squandering vast masses of paper every day on the publication of so much stuff that isn't worth either writing or reading. However, I did cull one little gem from this particular tabloid. It concerned the opening of a new radio and television shop at a place called Englewood in New Jersey. Everyone who bought a television set on the first day was presented with two tickets for a Broadway music hall show, a voucher covering dinner for four at a New York night club, a portable radio receiver and a magnifying lens for the televisor. Business, I gather, was brisk—as well it might be!

The Customer can be Wrong!

It's almost an axiom of the side of Big Business devoted to retail



Books Published for "Wireless World"

	Net Price	By post
RADIO VALVE DATA. Characteristics of 1,600 Receiving Valves	3/6	3/9
FOUNDATIONS OF WIRELESS. Fourth revised Edition, by M. G. Scroggie, B.Sc., M.I.E.E.	7/6	7/10
RADIO LABORATORY HANDBOOK. Fourth Edition, by M. G. Scroggie, B.Sc., M.I.E.E.	12/6	12/11
WIRELESS SERVICING MANUAL, by W. T. Cocking, M.I.E.E., Seventh Edition	10/6	10/10
TELEVISION RECEIVER CONSTRUCTION. A reprint of 10 articles from "Wireless World"	2/6	2/9
TELEVISION RECEIVING EQUIPMENT, by W. T. Cocking, M.I.E.E., Second Edition	12/6	12/11
RADIO DATA CHARTS, by R. T. Beatty, M.A., B.E., D.Sc., Fourth Edition—revised by J. McG.Sowerby, B.A., Grad.I.E.E.	7/6	7/11
HANDBOOK OF TECHNICAL INSTRUCTION FOR WIRELESS TELEGRAPHISTS, by H. M. Dowsett, M.I.E.E., F.Inst.P., and L. E. Q. Walker, A.R.C.S., Eighth Edition	30/-	30/8
WIRELESS DIRECTION FINDING. By R. Keen, M.B.E., B.Eng. (Hons.), Fourth Edition	45/-	45/9

Obtainable from all leading booksellers or from
LIFFE & SONS LTD., Dorset House, Stamford Street, London, S.E.1.

distribution that the salesman must take the view that the customer must be right. Actually, as Big Business jolly well knows, half the cost of high-pressure salesmanship lies in making the customer do the silliest things without realising that they are silly. What the poor mutt seldom grasps is that somebody has to pay for "free gifts" and that somebody won't be the vendor. One is glad to think that, on this side of the Atlantic at any rate, television has had little need to boost sales by offering purchasers of receiving equipment gifts, apparently free, which have to be paid for in the end.

Try This One

BELOW IS A HORRIBLE PROBLEM which members of the Slade Radio Society of Birmingham were recently asked to solve. I've written to the Secretary to ask for the official answer and I only hope he is kind enough to let me have it before this appears in print and readers start sending in solutions! Twisters of this kind in which someone is three times as old as someone else was . . . always drive me to the verge of insanity if I let myself be tempted into tackling them. You, I'm sure, will do it on your head—or in it. Well, here it is if you care to have a go.

A line cord is centre-tapped to form two arms of a bridge, Y and Z. The other arms comprise a resistance X and a small boy with a thirst for experiment.

The bridge is balanced and there is the same amount of line cord in each of the arms Y and Z.

The line cord has a resistance of 1 ohm to the foot and the ages of the small boy (S.B.) and his elder brother (E.B.) are together 16 years. The resistance of the S.B. is as many ohms as the E.B. is years old.

The E.B. is twice as old as the S.B. was when the E.B. was half as old as the S.B. will be when he is three times as old as his E.B. was when the latter was three times as old as the S.B.

The resistance C and the resistance of the line cord is half as much again as the difference between the resistance X and the resistance X and the resistance of the S.B.

What is the length of the line cord?

[For solution see page 223.—Ed.]

M

A wise decision . . .

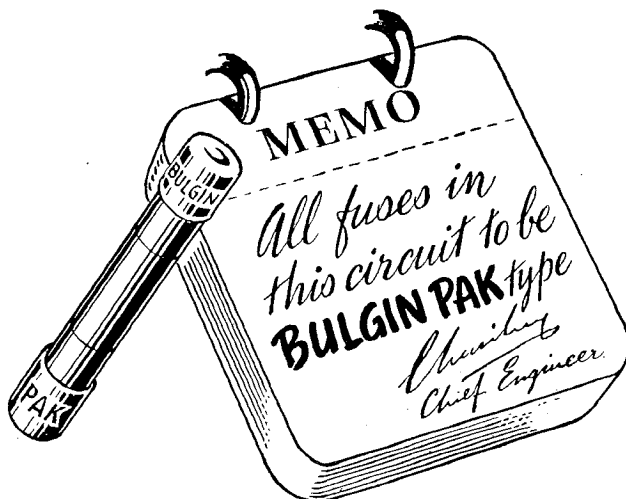

PAK delayed-action fuses answer the need for standard size fuses that will stand up to starting surges and peak currents in special circuits.

Designed and manufactured with the usual Bulgin care, these components will withstand varying overloads for up to 120 seconds and heavy peaks for brief periods, thus reducing unnecessary service calls, but ensuring safety.

STOCK VALUES

PAK 1 0.25A.	PAK 4 1.0A.
PAK 2 0.5A.	PAK 5 1.5A.
PAK 3 0.75A.	PAK 6 2.0A.

Special values to manufacturers requirements.
(Fit standard $\frac{1}{4}$ " x $\frac{1}{4}$ " ϕ fuse holders)

Retailers, have you obtained the new TRADE catalogue yet?



All Bulgin products are now available from retail and wholesale stockists.

The Choice

of Critics

BULGIN

The name Bulgin is a registered Trade Mark.

A. F. BULGIN & CO. LTD.,

BYE PASS ROAD, BARKING. TELEPHONE RIPPLEWAY 3474 (5 LINES).

RECENT INVENTIONS

A Selection of the More Interesting Radio Developments

Television Cameras

THE intensity of the scanning beam in a television tube of the so-called "Orthicon" or low-velocity type is automatically controlled in accordance with the average overall illumination of the scene being televised.

In the diagram, which only shows such details as are essential to the invention, a lens L projects the scene onto a photoelectric cathode P to release a stream of electrons, which are focused on to a mosaic screen S. Here they liberate secondary electrons, which are collected by a grid G1 in numbers proportional to the prevailing brightness of illumination. The grid is connected to earth through the resistances shown, and the resulting current builds up a negative charge on a condenser C. This is translated, by means of a valve V, into a corresponding rise in the positive potential of a point A in the anode circuit, which in turn is transferred to a grid G2 controlling the "gun" of the tube. The network of resistances shown ensures that the bias applied to the grid G2 is such as to maintain the scanning beam full modulated at all times; irrespective of variations in the background illumination. The final video signal VO is developed

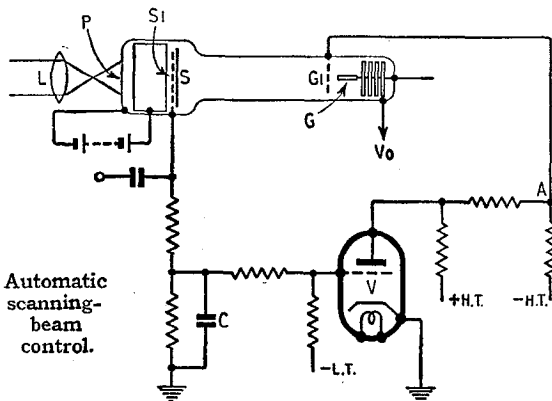

by a group of electron-multipliers in known manner.

Marconi's Wireless Telegraph Co., Ltd. (assignees of R. R. Thalner). Convention date (U.S.A.), January 9th, 1945. No. 610288.

Variable Permittivity

A CERAMIC dielectric, made of a mixture of barium and strontium titanites in the proportion of 95 parts to 5, possesses a permittivity which increases with the applied alternating voltage. Advantage is taken of this fact to make condensers which are inherently "voltage sensitive," and so can be used to secure automatic selectivity control and other desirable results.

If, for instance, the two circuits of an intervalve coupling of the bandpass

type are arranged to be exactly in tune for a predetermined level of signal strength, the inclusion of a voltage-sensitive condenser will cause progressive detuning of the circuit as the signal increases in strength; this automatically widens the acceptance band of the filter. Again, if a similar type of condenser is used to couple an aerial to the tuned input circuit of a wireless receiver, its initial low permittivity will ensure high selectivity for weak signals; though for stronger signals the resulting increase in the capacity coupling automatically acts as a damping factor on the input.

P. R. Coursey, L. J. Snell, Steatite & Porcelain Products, Ltd., and Dubilier Condenser Co. (1925), Ltd. Application date, October 2nd, 1945. No. 609824.

Television Suppressor Circuit

A KNOWN circuit for eliminating disturbances that exceed the peak white signals consists in connecting the anode lead from the amplifier to earth through a condenser and a diode, both of these being shunted by a resistance of such value that the time-constant of the combination is longer than that of the disturbing impulse.

According to the invention, the above circuit is made more effective by connecting the anode of the suppressor diode to the control grid of the amplifier, so as to apply negative reaction to the latter. Under normal conditions, the degree of reaction will be determined by the peak-white signal voltage, and is small. When a disturbing pulse arrives, it acts to open the diode and so automatically reduces the amplification of the main valve. This, in turn, serves more efficiently to eliminate the effect of the disturbance upon the received picture.

E. R. Blackler and Pyle, Ltd. Application date, February 28th, 1946. No. 608710.

Measuring Radiation Fields

AN appliance for taking field-strength measurements of energy radiated on wavelengths of the order of centimetres comprises a pick-up dipole D, Dr, which is mounted inside an evacuated bulb on a metallic stub support S, which also serves as a quarter-wave "insulator." The adjacent ends of the dipole are joined together by a fine wire W of Constantan alloy, the centre point of which is connected to a fine wire W1 of copper or Chromel alloy.

The two wires form a thermocouple having its hot junction located at the point of maximum pick-up current. The voltage developed across the sensitive couple is indicated on an external meter M connected to the pair of lead-in wires.

In an alternative arrangement, the simple dipole is replaced by the two halves of a split waveguide stub of rectangular cross-section. These are separately mounted, side by side, and the collected energy is fed to a thermo-

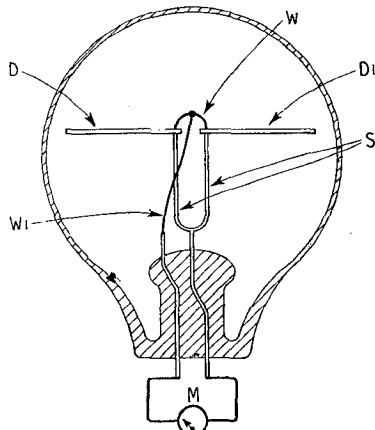

Thermocouple for centimetre field-strength measurement.

couple situated midway between the centres of their two opposite faces.

Philco Radio and Television Corp. (assignees of W. E. Bradley). Convention date (U.S.A.), December 31st, 1943. No. 610024.

Radio Cabinets

TO allow convenient access to the circuit components, for renewal or repair, the cabinet is moulded in two parts, each having the form of an open box. The edges of the open sides are flanged and recessed, so as to make a tight joint when the two parts are clamped together by long screws.

The chassis of the set is mounted on a pair of skid-like members, which fit into grooves along the base of the cabinet and are held in position by screws, preferably passing through the bottom of the front moulding. The rear moulding is more than half the depth of the complete cabinet, so as to expose the greater part of the chassis to inspection. A plug-and-socket switch automatically breaks the mains supply lead, when the two parts of the cabinet are separated.

De La Rue Plastics, Ltd.; F. E. Middleditch and S. R. Hawkins. Application date, December 7th, 1945. No. 606817.

The British abstracts published here are prepared with the permission of the Controller of H.M. Stationery Office, from specifications obtainable at the Patent Office, 25, Southampton Buildings, London, W.C.2, price 2/- each

permalloy permendur

STANDARD MAGNETIC MATERIALS have the unique advantage of being produced by a Company which itself is a large scale user of these materials, as a result of which a vast amount of direct experience in the use of magnetic alloys has become available. Permalloy Nickel/Iron Alloys are particularly suitable in cases which demand high permeability and low losses—especially low hysteresis loss: they should, however, be selected according to individual requirements. V-Permendur, one of the Cobalt/Iron alloys, should be employed where high permeability throughout a wide range of flux densities is called for, and it finds special application in diaphragms for high quality telephone receivers.

PERMALLOY C. Gives the highest initial permeability of any magnetic material yet known. Applications: wide frequency-band transformers: accurate current transformers, chokes, sensitive relays and magnetic shielding.

PERMALLOY B. Lower initial permeability than "C," but higher flux densities possible.

PERMALLOY D. High resistivity without undue lowering of flux density or of the Curie Point. Very suitable for certain high frequency applications since frequency permeability variation is small.

V-PERMENDUR. A Cobalt/Iron alloy with unusually high flux density. It can be rolled to .010 in. strip and exhibits high permeability up to high flux densities.

	Permalloy "B"	Permalloy "C"	Permalloy "D"	V. Permendur
Specific gravity	8.3	8.6	8.15	8.2
Electrical resistivity, microhms per cm. cube ...	55	60	90	26
Temperature for heat treatment C° C ...	900	1,050	900	790
Initial permeability μ_{max} ...	1,800 to 2,400	10,000 to 30,000	1,500 to 2,000	700 to 1,000
Maximum permeability μ_{max} ...	10,000 to 20,000	50,000 to 100,000	6,000 to 8,000	3,000 to 5,000
Magnetising force for μ_{max} oersteds ...	0.30 to 0.60	0.025 to 0.04	0.5 to 1.0	2.0 to 6.0
Maximum flux density, gauss ...	16,000	8,000	13,000	23,000
Coercive force in oersteds for $B_{max} = 5,000$ gauss ...	0.25	0.03	0.5	—
Remanence in gauss for $B_{max} = 5,000$ gauss ...	4,000	3,500	3,500	—
Hysteresis loss in ergs per c.c. per cycle for $B_{max} = 5,000$ gauss ...	300	45	550	—
Total loss in watts /lb. $B = 5,000$ gauss, 50 c/s 0.015 in. sheet	0.11	0.04	0.2	—

Standard
MAGNETIC MATERIALS

Standard Telephones and Cables Limited

(Registered Office : Connaught House, Aldwych, London, W.C.2)

NORTH WOOLWICH • LONDON • E.16.

TELECOMMUNICATION ENGINEERS

Telephone : Albert Dock 1401



**THE COMPLETE SERVICE
FOR SOUND RECORDING AND
REPRODUCTION**

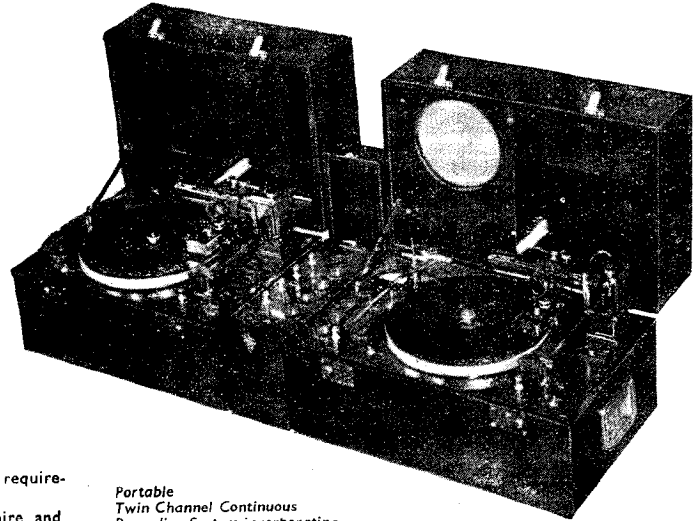

Portable
Twin Channel Continuous
Recording System incorporating
CDR49A Recorder/Amplifier
DR49A Recorder and EM49A Electronic
4 Channel Mixer

- ★ Mobile, static and specialised recording units
- ★ Recording amplifiers, speakers, microphones, etc
- ★ Sapphire cutting and reproducing styli
- ★ Blank recording discs from 5in. to 17in. Single and Double-sided
- ★ Groove locating and cueing devices
- ★ A comprehensive range of accessories to meet every requirement of the sound recording engineer
- ★★ A development of special interest to users of sapphire and delicate pick-ups—THE SIMTROL. This is a controlled micro-movement easily fitted for use with any type of pick-up
- ★★★ OUR CDR49A RECORDER UNIT complete and self-contained, measuring only 22in. x 14in. x 13½in., incorporating 8-valve amplifier, recorder unit, light-weight pick-up, speaker and microphone and with many exclusive features, is now ready for early delivery.

**OUR WELL-EQUIPPED WORKSHOPS ARE AVAILABLE FOR THE
DEVELOPMENT OF EQUIPMENT TO MEET SPECIAL NEEDS.**

SIMON SOUND SERVICE, Recorder House, 48/50, George St., Portman Square, London, W.1.

CABLES: Simsale, London

TELEGRAMS: Simsae. Wesdo, London

TELEPHONE: Welbeck 2371 (4 lines)

THIS COLD CATHODE THYRATRON..
*High cathode current -
Stability - Long life*

This new Mullard 1267 will be welcomed by all users of cold cathode thyratrons. A replacement for, and an improvement upon, the OA4G, it has the following outstanding advantages:—

- (1) High continuous and instantaneous cathode current.
- (2) Consistent striking characteristics.
- (3) Higher stability and freedom from photoelectric and temperature effects.
- (4) Reliability and long life resulting from improved cathode activation.

These features make the 1267 ideal for a great number of industrial electronic applications, the more important of which include:—

- Welding and industrial engineering timers.
- Alarm, fault and protective systems.
- Sequential process timers.
- Remote-controlled power switching.

PRINCIPAL CHARACTERISTICS	
*Max. Operating Anode Voltage	... 225V peak
Trigger Voltage for firing (Pos.)	... 70V. min. to 90V. max.
Trigger Current at Striking Point (V _a =140)	... 100µA max.
Valve Voltage Drop	... 70V. approx.
Max. Continuous Cathode Current	... 25 mA
Max. Peak Cathode Current	... 100 mA

* Above this voltage the valve may break down at V_g=0.

Mullard

*thermionic valves
and electron tubes*

Industrial Power Valves · Thyratrons · Industrial Rectifiers · Photocells · Flash Tubes · Accelerometers
Cathode Ray Tubes · Stablisers and Reference Level Tubes · Cold Cathode Tubes · Electrometers, etc.

Wharfedale

NEW GOLDEN 10 inch LOUDSPEAKER...

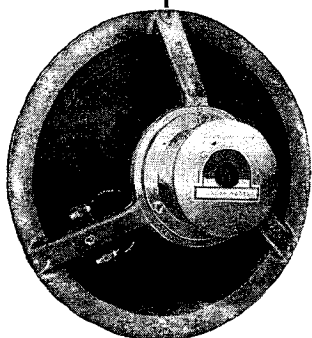

During the last eight years hundreds of Wharfedale Golden Units have been supplied to the B.B.C. and G.P.O.

The Speaker was selected by reason of its level response, and makes an ideal Unit for reproduction free from resonance peaks. It is fitted with precision die-cast chassis, improved spider and Alcomax II Magnet, with a flux density of 12,500 lines.

Ask your dealer or send for book "Loudspeakers" by G. A. Briggs, 5/-, in which acoustic loading is fully explored.

Speech coil
3 or 15 ohms
impedance
PRICE 75/-

Made and Guaranteed by

WHARFEDALE WIRELESS WORKS

BRADFORD ROAD, IDLE, BRADFORD
Telephone : IDLE 461. Telegrams : Wharfedel, Idle, Bradford



18, TOTTENHAM COURT ROAD, LONDON, W.1

Tel: MUSEum 2453

Tel: MUSEum 4539

Shop hours: Monday-Friday 9—5.30. Saturday 9—1.

FULL MAIL ORDER FACILITIES Please add postage

TELEVISOR COMPONENTS.

Coils. Bel Sound Products complete sets of boxed coils wound strictly in accordance with original specifications.

"Wireless World" TRF Televisor Receiver type £2 8 9
"Wireless World" Superbet Televisor Receiver type £2 12 6
Electronic Engineering Televisor 15 0

Scanning Equipment

Scanco Television Scanning Coils £1 5 6
Scanco Television line output transformer 4.5 : 1 £1 5 6
Scanco Television focus coil type ST8 Max. d.c. 40 mA £1 10 0
Scanco Television type ST18 Resistance 300 ohms Max. d.c. 150 mA. £1 7 0

Potentiometers.

Colvern wire wound potentiometers 3 watt type, 2K, 2.5K, 5K, 10K, 50K 5 6
100K 6 8
Morganite carbon potentiometers, all popular values, less switch 4 6
With switch 6 6

Wire (for "Wireless World" Televisor).

1 lb. Reel 26 SWG enamel (Line O/P transformer) 2 2
1 lb. Reel 28 SWG enamel (Line Deflector coils) 2 3
1 lb. Reel 34 SWG enamel (Line O/P Transformer) 2 9
1 lb. Reel 36 SWG enamel (Focus and Receiver coils) 3 0
1 lb. Reel 38 SWG enamel (Receiver coils) 3 4
1 lb. Reel 40 SWG enamel (Frame coil and Receiver coils) 3 9
1 lb. Reel 42 SWG enamel (Blocking Osc. trans.) 4 3
1 oz. Reel 26 SWG D.S.C. (Receiver coils) 1 6
1 oz. Reel 26 SWG D.S.C. (Receiver coils) 1 6

Valves.

Mullard EA50's 10 6 plus 2 4 P. Tax.
Mullard EP50's 17 6 plus 3 10 P. Tax.
Mullard EB33 9 6 plus 2 1 P. Tax.
Mullard EL33 10 6 plus 2 4 P. Tax.
Mazda T41's 10 6 plus 2 4 P. Tax.
Mazda Pen45 10 6 plus 2 4 P. Tax.

Valves—Continued

Mazda UUS 15 0 plus 3 3 P. Tax.
Mazda U22 15 0 plus 3 3 P. Tax.
Cathode Ray Tube GEO6501, Mazda CRM91.
Mullard MW22/14C £9 0 0 plus 46 10 P. Tax.
Rubber mask for above—Black: 9in. 9/8, 12in. 18/-; White: 9in. 11/8, 12in. 21/6.

Valveholders.

	British		American
Diode valveholder	9	4-pin Medium Amphenol	9
4-pin Amphenol	9	4-pin Medium Ceramic	1 6
4-pin Ceramic	1 0	5-pin Medium Paxolin	9
5-pin Amphenol	9	5-pin Medium Ceramic	1 6
5-pin Ceramic	1 0	6-pin Medium Paxolin	9
7-pin Amphenol	9	7-pin Medium Paxolin	9
7-pin Ceramic	1 3	7-pin Medium Ceramic	1 6
Mazda Octal Amphenol	9	Octal Medium Amphenol	9
Mazda Octal Ceramic	1 6	Octal Medium Ceramic	1 6
EP50 type Micalex	9	8-pin Locktal Amphenol	1 0
EP50 type Ceramic	1 6		
BSA (New British base)	1 6		
B7G (7-pin Peanut) Ceramic	1 6		
B7G complete with screening can	3 0		

Miscellaneous.

Belling & Lee Coaxial plug L604P 1 6
Belling & Lee Coaxial socket L604S 1 6
Belling & Lee connector (for joining co-ax. cable) 1 6
Bulgin 3-pin mains plug and socket 4 0
1in. Coaxial cable 78 ohms stranded centre, per yd. 1 3
Eric resistors—over 500 values from stock
1/2 and 1/4 watt, 20% 4 6
1/2 and 1/4 watt, 10% 1 6
1/2 and 1/4 watt, 5% 1 6
1 watt, 20% 8 8
2 watt, 20% 1 0

THE COMPONENT SPECIALISTS

OUTSTANDING OFFERS

for the discerning Amateur

BC454B. (The Famous "Command" Communications Receiver)

Fitted 6 valves, types as follows : 3 12SK7's, 1 12K8, 1 12SR7, 1 12A6. Frequency Range 3-6 Mc's (50 m.-100 m.) IF value 1415 kc's.
BC455B. Exactly the same specification but Frequency Range 6-9.1 mc's (30 m.-50 m.) IF value 2830 kc's.
 Brand new in sealed cartons. **Unbeatable Value.**

each **30/-** Post 1/3

Full Circuit Diagram 1/-

Either set convertible to Medium Waves with our Special Coil Assembly, Price 10/- including Diagram of Connections.
 Special Press-in Tuning Spindle and Knob, 2/6.

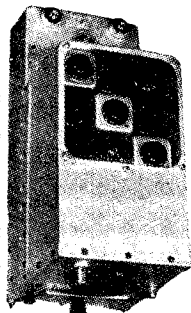

230v. A.C. **COMMAND POWER PACK FOR BC453, BC454, BC455**

45/-
post paid

Wired and Tested. Fitted 6 x 5 Rectifier. Just Clip On. No Alterations to Wiring. Mains Cord fitted ready for instant use.

These units are manufactured by us exclusively to highest standard.

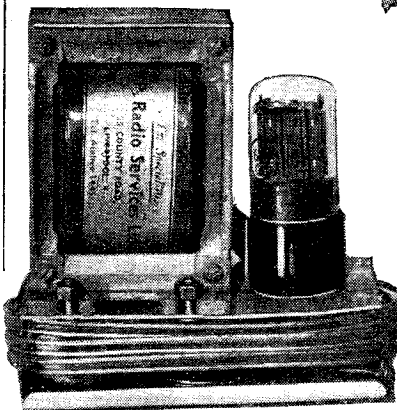

DELIVERY PER RETURN GUARANTEED

BC348 Receivers, modified to 230 v. A.C., £22/10/-
Two only, AR88LF Receivers. Perfect condition. Each £40.
Six only, Type 78 Receivers. Brand new, 50/- each.
BC966A Receivers, 13 valves, motor gen., etc., 30/-, carr. 5/-
ABK1 Receivers, 10 valves, motor gen., etc., 25/-, carr. 5/-
456B Modulator Units, 1625, 1215, VR150, as new, 12/6.
RF Units. Brand new in sealed cartons. Type 24, 12/6 ; Type 25, 19/6, post 1/3.
Control Box and Cable for BC453/4/5, 12/6, post 1/4.
IF Transformers for BC454B, 455B, per set of 3, 10/-, post 9d.
Amplifier Vibrator Packs, 12 v., OZ4 and 6K6, new, 25/-, post 1/4.
DYNAMOTORS for BC453/4/5, 28 v., 7/6, post 1/-.
Moving Coil Headphones, with moving coil hand microphone, 7/9, post 9d.
Milliampmeters, 0-100 mA., 2in. sq., 2/9, post 6d.
CONDENSERS, 350 v., .001, .02, .05, .1, 4/- doz.
Ex-R.A.F. IF/AF Amplifier Unit, Type 1355, fitted 10 valves, as specified for "Inexpensive Television", in original sealed crates. Brand new, 49/6, carr. paid.
VC97 Cathode Ray Tubes, 39/6, carr. 2/6. Bases, 4/-
5FP7 C.R. Tubes, magnetic, complete in shroud with coils and brilliance control. Brand new, 3 gns., carr. 2/6.
Radar Indicators, BC929a, 7 valves. Brand new, 35/-, post 1/4.
Radar Indicators, Type R-31APS. Has 40 valves, 6L6's, etc., 16 gns., carr. 10/- (see "Wireless World," April).
Mains Radio Interference Suppressors, 10/-, post 1/-
Dual Range Coil Units for B.C. AR299/429. 201-398 kcs., 4150-7700 kcs. Brand new in cartons, each 7/6, post 9d.
Super Sensitive Midget Relays, DP., 200 ohms, 3/6, post 6d.
Transmitter Tuning Units TU5b, 22/6, carr. paid. TU8, in new condition, 12/6, carr. paid.
New 2 waveband AC/DC Radio Receivers. Well-known make, £5/10/- each, carr. 3/6. A few only. Originally 11 gns.
Mains Transformers, 28 v. LT., 220-0-220, 80 ma., 25/-, post paid.

H.P. RADIO SERVICES LTD.

Britain's Leading Radio Mail Order House
 55 COUNTY RD., WALTON, LIVERPOOL, 4

Established 1935

Telephone : Aintree 1445

STAFF CALL SIGNS GDGL G3DLV

THE RD JUNIOR HIGH FIDELITY AMPLIFIER

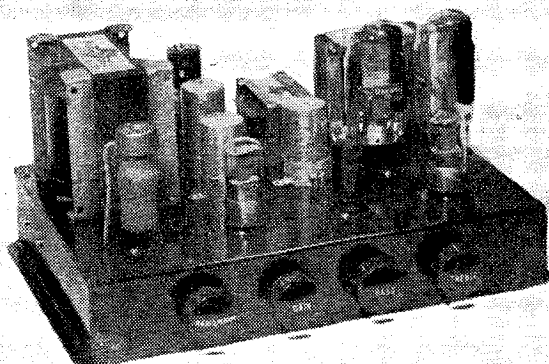

An illustrated brochure describing this amplifier in detail will be forwarded on request.

The "RD JUNIOR" amplifier completely wired and tested **£19 10 0**

Complete kit of parts for construction of the amplifier, including all valves and ready drilled chassis finished in dark maroon **£16 17 0**

Complete set of drawings, including circuit diagram, layout diagram, and component list **7 6**

ROGERS DEVELOPMENTS Co

106 HEATH STREET, HAMPSTEAD, LONDON, N.W.3
 Phone: HAMPstead 6901

MAINS TRANSFORMERS SCREENED, FULLY INTERLEAVED AND IMPREGNATED.

H.S.63. Input 200/250 v. Output 250/0/250 v., 60 m/a., 6.3 v. 3 amps., 5 v. 2 amps.	15/6	
H.S.40. Windings as above. 4 v. 4 amps., 4 v. 2 amps.	15/6	
H.S.2. 200/250 v. 250/0/250 v. 80 m/a.	17/6	Half Shrouded
H.S.30. 200/250 v. 300/0/300 v. 80 m/a.	17/6	
H.S.3. 200/250 v. 350/0/350 v. 80 m/a.	17/6	
H.S.2X. 200/250 v. 250/0/250 v. 100 m/a.	19/6	
H.S.30X. 200/250 v. 300/0/300 v. 100 m/a.	19/6	
H.S.3X. 200/250 v. 350/0/350 v. 100 m/a.	19/6	
F.S.2. 200/250 v. 250/0/250 v. 80 m/a.	19/6	
F.S.30. 200/250 v. 300/0/300 v. 80 m/a.	19/6	
F.S.3. 200/250 v. 350/0/350 v. 80 m/a.	19/6	Fully Shrouded.
F.S.2X. 200/250 v. 250/0/250 v. 100 m/a.	21/6	
F.S.30X. 200/250 v. 300/0/300 v. 100 m/a.	21/6	
F.S.3X. 200/250 v. 350/0/350 v. 100 m/a.	21/6	
All above have 6.3-4.0 v. at 4 amps., 5-4.0 at 2 amps.		
F.S.43. Input 200/250 v. Output 425/0/425 v. 200 m/a., 6.3 v. 4 amps C.T., 6.3 v. 4 amps C.T. 5 v. 3 amps.	42/6	Fully Shrouded.
F.S.35. Input 200/250 v. Output 350/0/350 v. 250 m/a., 6.3 v. 6 amps, 4 v. 8 amps., 0-2-6.3 v. 2 amps., 4 v. 3 amps.	98/6	
F.S.50. Input 200/250 v. Output 450/0/450 v. 250 m/a., 6.3 v. 2 amps. C.T., 6.3 v. 4 amps. C.T., 5 v. 3 amps.	77/6	
F.30X. Input 200/250 v. Output 300/0/300 v. 80 m/a., 6.3 v. 7 amps., 5 v. 2 amps.	26/6	Framed Flying Leads.
E.H.T.2. 2,000 v. 5 m/a., 2-0-2 v. 2 amps, 4 v. 1.1 amps.	35/-	
The above have Inputs of 200/250 v.		
F.4. Filament Transformer. Input 200/250 v., 4v. 2 amps.	7/6	
F.6. Filament Transformer. Input 200/250 v. 6.3 v. 2 amps.	7/6	
F.12. Filament Transformer. Input 200/250 v. 12.6 v. tapped at 6.3 v. 3 amps.	15/6	Framed Flying Leads.
F.24. Filament Transformer. Input 200/250 v. 24 v. tapped at 12 v. 3 amps.	21/6	

H. ASHWORTH (Dept. W.W.)

676, GREAT HORTON RD., BRADFORD, YORKS.

*The basis
of world
standards*

Technical excellence supported by constant research and an unrivalled knowledge and experience of Radio Frequency Cable applications, ensures the continuance of the lead established by TELCON in the Radio Frequency Cable field.

Even before the introduction of Telcothene as a cable dielectric, an application pioneered by TELCON, a range of Radio Frequency cables with unique capacity and attenuation characteristics was produced, using Telconax.*

Today, developments are still going on and the solution of any problems involving the application of Radio Frequency cables will be found in the wide range manufactured by TELCON.

** Telcothene (Regd.)—Polythene processed by Telcon to provide specific characteristics.*

TELCON R.F. CABLES

THE TELEGRAPH CONSTRUCTION & MAINTENANCE CO. LTD

Head Office: 22, OLD BROAD STREET, LONDON, E.C.2.

Enquiries to TELCON WORKS, GREENWICH, S.E.10.

Telephone: LONDON Wall 3141

Telephone: GREENWICH 3291



Founded 1864

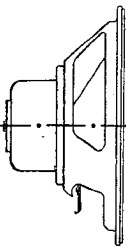

perfect alignment by

Co-axial Construction—

FOR "BETTER LISTENING"

R. & A. Reproducers are perfectly aligned about their axis. Their assembly is so arranged that the voice coil can never, except under conditions of brute force, vary from its setting in the annular gap by more than .001 ins. Misalignment of the voice coil and/or mechanical failure is therefore almost impossible, no matter what the volume or frequency.

A co-axially constructed, distortion-free speaker is a necessity for Better Listening.

"The Story of Co-axial Construction" explains how our speakers are built. We will gladly send a copy to any manufacturer or Overseas Buyer who writes for one.

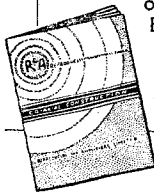

REPRODUCERS AND AMPLIFIERS LIMITED
FREDERICK ST. WOLVERHAMPTON ENGLAND

R & A

Loudspeakers



SH.15 OPEN-AIR REPRODUCER

For the relaying of Orchestral Concerts and similar applications where the highest possible quality of reproduction is required in the open air.

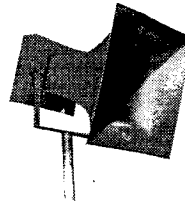

SH.6 GENERAL PURPOSE REPRODUCER

A loudspeaker for all general purpose public address in the open air, arranged in groups or dispersed as required. Independent wattage adjustment on internal line transformers. Horn detachable for storage.

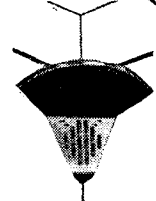

SB.6 THE QUARTER BAFFLE

An indoor loudspeaker for schools, hospitals, restaurants, hotels, public buildings, etc. In effect a quarter segment of a circle 18in. radius which, when used in the corner of a room provides the equivalent performance of a 3 foot circular baffle. Independent wattage adjustment, etc.

CL.2 THE CONCERT LABYRINTH

Designed for the highest quality reproduction in the home—recording playback broadcast monitoring, etc.

£48. 0. 0d. List.

SL.15 LABYRINTH SPEAKER

A loudspeaker for high quality public address indoors. Cinemas—Theatres—Dance Halls—Schools, etc.

£19. 10. 0d. List.

£23. 0. 0d. List.

£9. 0. 0d. List.

£4. 12. 6d. List.

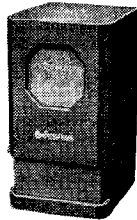

ACOUSTICAL
MANUFACTURING CO. LTD.

HUNTINGDON

Telephone : HUNTINGDON 361

THE

COIL PICK-UP

“—SURPASSES ALL OTHER MODERN PICK-UPS FOR REALISM AND GOOD QUALITY REPRODUCTION—”

The price is rather higher than that of instruments of poorer performance. The pick-up costs £4.0.0 plus £1.15.0 tax. It is normally used with our equalizer costing £1.15.0 or a straight transformer at £1.5.0.

Heads are available, made to fit standard auto-changer arms. They cost £3.0.0 plus £1.6.8 tax.

Miniature steel or thorn needles fit the pick-up and special sapphires costing 10/- plus 4/5d. tax are available.

WILKINS & WRIGHT LTD.
HOLYHEAD ROAD, BIRMINGHAM 21

EXTENSION SPEAKER, in walnut cabinet. Walnut louvres, volume control, R. & A. High-Fidelity 8in. speaker. Size of cabinet 11in. high, 17in. long, 8in. deep at bottom sloping to 6in. at top. Cut-out for speaker on back, 39/6, plus 2/6 postage, packing and insurance.

MAINS TRANSFORMER, drop through type, semi-shrouded, input 210, 230, 250 volts. Secondary 350-0-350, 80 mills, 6 volt, 3 amp., 5 volt, 2 amp., 16/-, plus 1/- postage.

MAINS TRANSFORMER.—Input 110-250 volt. Secondary 350-0-350 volt, 150 mills, 6 volt c.t., 4 amp., 6 volt, 2 amp., 5 volt tapped, 1 volt, 4 amp. 26/-, plus 2/- postage and packing.

MAINS TRANSFORMER.—Input 110-250 volt. Secondary 350-0-350 volt, 250 mills., 6 volt, 4 amp., 6 volt, 3 amp. 5 volt tapped, 1 volt, 4 amp. 37/6, plus 2/6 postage and packing.

CHARGER, comprising transformer and rectifier giving 12 volt $\frac{3}{4}$ amp., 6/6.

IRON CORED 465 kc. IF's. Q120, 5/6 pair.

ELECTROLYTICS by well-known makers. 2 mfd. 350 working 9d., 4 mfd. 450 working 1/2, 8 mfd. 450 working 1/11, 16 mfd. 450 working 2/3, 8-16 mfd. 450 working 3/6, 16-16 mfd. 450 working 3/11, 16-24 mfd. 350 working 2/11, 50 mfd. 12 volt working 1/-, 25 mfd. 25 volt working 1/-.

Write for lists.

D. COHEN
67 Raleigh Ave., Hayes, Middx.



To former members of the Royal Air Force

THE ROYAL AUSTRALIAN AIR FORCE

offers you first-class pay
and prospects

THE ROYAL AUSTRALIAN AIR FORCE has vacancies in more than twenty trades (see list) for large numbers of former airmen of the Royal Air Force.

Preference will be given to single men. The initial engagement is for twelve years. The age limit for applicants is 40; but only applicants under 33 years of age will have a chance of being re-engaged (for two periods of five years each) up to the retiring age of 55, and thus qualifying for a pension.

The Royal Australian Air Force offers:

GOOD PAY—consider these rates: from 13/- a day (Australian Currency) for a Group IV airman to 25/6 a day (Australian Currency) for a Group I Warrant Officer: plus, of course, free uniform, kit and uniform allowance, free rations and quarters or generous allowances in lieu thereof, also marriage and separation allowances, travel and removal expenses.

GOOD PROSPECTS: The R.A.A.F. is an expanding force. Your prospects of promotion are therefore very good.

WIDE CHOICE OF OCCUPATION: There are over 100 separate trades in the R.A.A.F., and specialised training is given where needed.

OPPORTUNITY TO FLY: Many members of the ground-staff are already being trained as aircrew.

GOOD LEAVE—three weeks' leave a year, plus public holidays; extra leave, plus travelling time, for airmen in certain distant areas; cumulative sick leave; and six months' long service leave on full pay after twenty years' service.

FULL WELFARE SERVICES AND BENEFITS—including free dental and medical attention, pension at 55 or a generous gratuity after twelve years' service.

SPORT AND EDUCATION: Free facilities, grounds and equipment for tennis, boxing, cricket, football, athletics, and at coastal stations also swimming, fishing and sailing; also educational centres, reading rooms, and tuition, by correspondence or in classes, for the improvement of your general education.

FREE PASSAGE TO AUSTRALIA: Successful applicants are attested in Britain, and are then immediately entitled to all the privileges of the Royal Australian Air Force, including free passage to Australia.

For form of application and further information, call or write (stating your former R.A.F. number, rank and trade, present age, and whether you are married or single) to

THE RECRUITING OFFICER R.A.A.F.,
Dept. Air 23 Canberra House, 87 JERMYN STREET, LONDON, S.W.1.

WANTED

GROUP I Carpenters (General, Rigger and M.B.B.), Copper-smiths, Electrical Fitters and Mechanics, Fitters (Armourer, D.M.T., IIA and IIE), Instrument Makers, Radar Mechanics "A" and "G", Turners, Wireless Maintenance Mechanics.

GROUP II Fabric Workers, Motor Trimmers, Telegraphists.

GROUP III Clerks (General), Cooks and Equipment Assistants.

GROUP IV Cooks' Assistants and Stewards.

QUARTZ

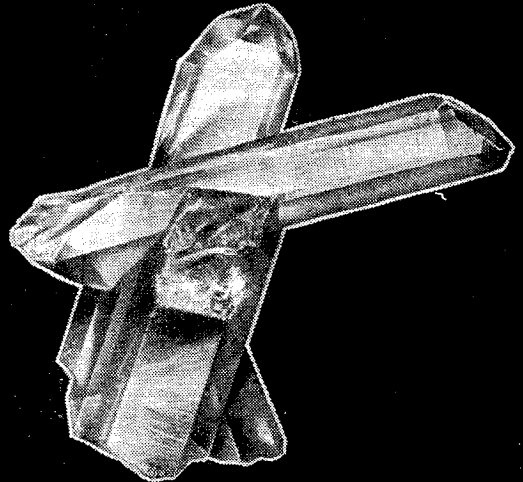

CRYSTALS

MARCONI QUARTZ CRYSTALS are made to satisfy the highest possible standards because nothing but the highest standards satisfy the designers of Marconi equipment.

Mounted in an evacuated glass envelope, with a Type B7G base, Marconi Crystals can now be supplied to all Manufacturers in the following ranges:—

75-150 kc/s
200-500 kc/s
2-15 Mc/s
12-35 Mc/s (overtone plates)

Frequency Tolerance . . .005%

Temperature Coefficient . . 2 parts in 10⁶ per degree C.

Enquiries are also invited for other types to suit specific requirements.

Marconi

MARCONI'S WIRELESS TELEGRAPH COMPANY LIMITED
MARCONI HOUSE, CHELMSFORD, ESSEX

COULPHONE RADIO PRODUCTS

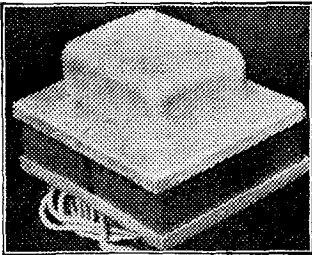

COULPHONE COIL PACKS. Medium, Long and Short Wave. Built on 16 S.W.G. Aluminium chassis. Totally enclosed. One hole fixing. Aligned ready for connection into receiver. I.P. 465 kc/s.

MODEL A. For use with 2 gang tuning condenser. 6K8G or any triode hexode frequency changer. £1/19/6.

MODEL AE. For use with 3 gang tuning condenser. R.F. Stage for 6K7G, and 6K8G. Nine iron dust cored coils, £3/17/6.

COULPHONE 20-WATT HIGH FIDELITY AMPLIFIER. Built to famous Williamson circuit but with push-pull 807's for higher power output. Linear response from 20—20,000 c.p.s. Power supply for feeder unit or tone control unit brought out to octal socket. 6.3 v. 4A and 250 v. 40 mA. £22/10/-.

EX GOVT. SURPLUS. COULPHONE offer the best bargains. Over 200 items in our illustrated catalogue. If interested please send extra 24d. stamp—it will save you 5s.

ROTHSCHILD "TORPEDO" MIKES. List Price, £18/18/-. My price £3/18/6. Post paid.

Terms: C.W.O. or C.O.D.

MAINS TRANSFORMERS

16/6 POST PAID

Coulphone Mains Transformers are made to the highest electrical standards and are fully guaranteed. We supply them to the Ministry of Supply Atomic Research Stations, so they will no doubt meet your requirements. Special quotations for quantities and types to order.

Standard Replacement Types. Drop-through chassis type with top shroud. Impregnated and interleaved Screened Primaries tapped for 200/230/250 volts.

- (a) 250-0-250 v. 60 mA. 6.3 v. 3 A., 5 v. 2 A. ... 16 6
- (b) 250-0-250 v. 60 mA. 4 v. 4 A., 4 v. 2 A. ... 16 6
- (c) 250-0-250 v. 80 mA. 0/4/6.3 v. 4 A. C.T. 0/4/5 v. 2 A. ... 19 0
- (d) 300-0-300 v. 80 mA. 0/4/6.3 v. 4 A. C.T. 0/4/5 v. 2 A. ... 19 0
- (e) 350-0-350 v. 80 mA. 0/4/6.3 v. 4 A. C.T. 0/4/5 v. 2 A. ... 19 0
- (f) 250-0-250 v. 100 mA. 0/4/6.3 v. 4 A. C.T. 0/4/5 v. 2 A. ... 22 0
- (g) 300-0-300 v. 100 mA. 0/4/6.3 v. 4 A. C.T. 0/4/5 v. 2 A. ... 22 0
- (h) 350-0-350 v. 100 mA. 0/4/6.3 v. 4 A. C.T. 0/4/5 v. 2 A. ... 22 0
- (i) 350-0-350 v. 150 mA. 0/4/6.3 v. 6 A. C.T. 0/4/5 v. 2 A. ... 39 0
- (j) 425-0-425 v. 180 mA. 6.3 v. 4 A. C.T., 6.3 v. 4 A. C.T., 5 v. 3 A. ... 44 6
- (k) 425-0-425 v. 180 mA. 4 v. 8 A. C.T., 4 v. 4 A. C.T., 4 v. 4 A. ... 44 6
- (l) 425-0-425 v. 180 mA. 6.3 v. 4 A. C.T., 4 v. 2 A. C.T., 4 v. 2 A. C.T., 5 v. 3 A. ... 47 0

Types (a) (b) (c) (d) (e) (f) (g) (h) (k) illustrated on left. Types (i) (j) (l) upright shrouded type.

WILLIAMSON OUTPUT TRANSFORMER

A super job exactly to author's specification. Upright mounting £3/12/6

Send 24d. Stamp for New 48-page Illustrated Catalogue.

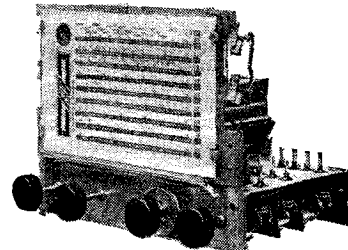

FEEDER UNITS

MODEL B DE LUXE (illustrated above). High gain R.F. stage operative on all nine wavebands. 45/145 M., 190/550 M., 900/2000 M. Plus six ranges of Bandspread, 13.5-14.8, 16-17.4, 19-20.5, 24.2-26, 30-32, 41-43.5 metres. Large colour printed glass dial, 10in. x 6in. aperture. Horizontal drive. Wave-range indicator and magic eye. Switched pick-up sockets. Volume and Tone Controls. Completely aligned ready for connection to audio amplifier. Price less valves £18/7/6.

Valves required, 6F50, 6K8G, 6K7G, 6Q7G, 6U5. Price for set of five valves, £3/11/5.

MODEL A. A first class feeder unit with R.F. stage operative on all wavebands, 16/50, 190/550, 900/2000 metres. Switched pick-up sockets. Volume control. Glass dial 8in. x 6in. in colours. Completely aligned ready for connection to audio amplifier. Price less valves, £10/8/6.

Valves required, 6K7G, 6K8G, 6K7G, 6Q7G. Price for set of four valves, £2/11/8. **A.F. AMPLIFIER POWER UNIT.** Specially designed for use with above units. Employs 6V6G output (4 watts) and 5Z4G rectifier. Price less valves £4/10/-.

Two valves if required, £1/13/10.

NEW GOODS ONLY

COULPHONE RADIO 53 BURSCOUGH ST. ORMSKIRK, LANCS.

"The Return of Post Mail Order Service"

Tel.: Ormskirk 987

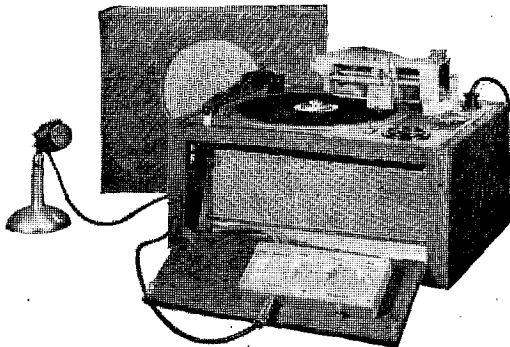

BROWN—E.R.D. 13 inch Portable Disc Recorder
An important S. G. Brown product

Brown-E.R.D.

DISC RECORDER
Incorporating the latest advances
in Sound-on-Disc Recording

Write for interesting brochures presenting full technical details of this latest development in Sound-on-Disc recording. Also 17 inch models for the Professional user.

S. G. BROWN LTD., Shakespeare St., WATFORD

Established in Electro Acoustics and high precision Engineering for over 40 years. Manufacturers of the world-famous 'BROWN' Gyro Compass.

Telephone: Watford 7241

High Fidelity Reproduction.

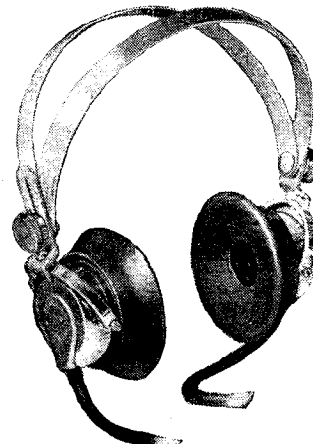

TYPE "K."

The S. G. Brown Type "K" Moving Coil headphones, with the following outstanding characteristics, supply that High Fidelity Reproduction demanded for DX work, monitoring and laboratory purposes, etc.

CHARACTERISTICS.

D.C. RESISTANCE, 47 Ohms.

IMPEDANCE 52 Ohms at 1,000 c.p.s.

SENSITIVITY, 1.2 x 10⁻¹² Watts at 1kc. = .0002 Dyne/cm²

Descriptive Literature on request

PRICE £5.5.0 PER PAIR

Your Local Dealer can supply

For details of other S. G. Brown Headphones (prices from 30/- to 77/6) write for illustrated Brochure "W.W."

HEADPHONES WHICH UPHOLD BRITISH PRESTIGE

Telephone: Watford 7241

S.G. Brown, Ltd.

SHAKESPEARE STREET, WATFORD, HERTS.

MASTERPIECE IN MINIATURE

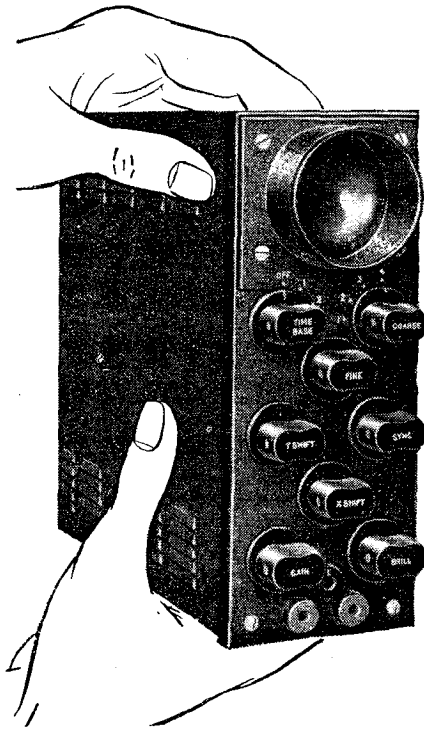

WIDTH	2½"
HEIGHT	6¾"
DEPTH	9¼"
C.R.T. DIAMETER	1½"
NETT WEIGHT	7½lbs

Miniscope

MINIATURE CATHODE RAY OSCILLOSCOPE BY

G.E.C.

Full specification from: THE GENERAL ELECTRIC CO., LTD., MAGNET HOUSE, KINGSWAY, LONDON, W.C.2

ROLA

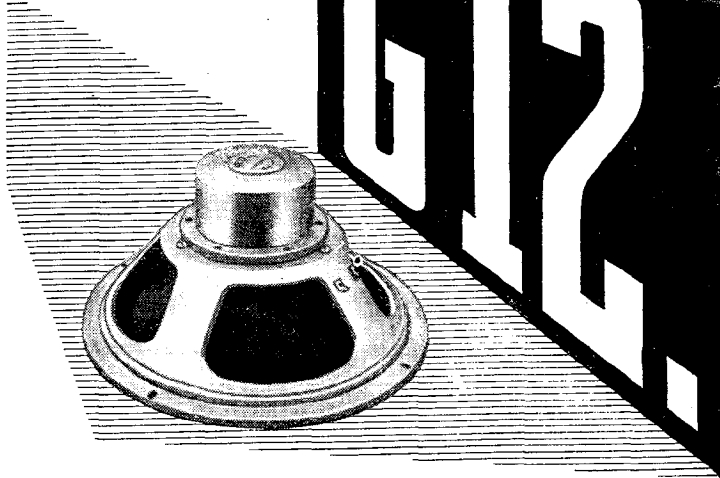

Maximum sensitivity with uniform frequency response from a more compact speaker, appreciably reduced in weight—that is what Rola technicians have achieved with the new G.12. Special features include dust-proof suspension completely protecting coil and magnet gap and the powerful Alcomax II magnet. Write for details and also for particulars of Rola 3" and 4" P.M. models, dust-proofed and equipped with Alcomax II magnets.

**best
of the
BIG
speakers**

BRITISH ROLA LTD. · FERRY WORKS · SUMMER ROAD · THAMES DITTON · SURREY

Telephone : EMBERBROOK 3402 (5 lines)

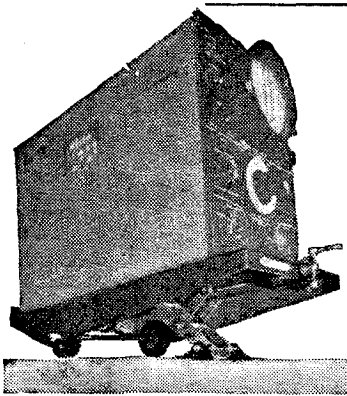

From all points of view . . .

... the Nagard Universal Mounting is a "must" for Oscillograph users. With it, there are no parallax errors when viewing the CRT screen since easy vertical and horizontal movements bring the axis of the CRT to your viewing position. No need to improvise tilts and no straining to lift the Oscillograph.

The Nagard Universal Mounting increases accuracy of observations and adds comfort to working conditions.

Suitable for all makes of portable oscillographs.

NAGARD

UNIVERSAL OSCILLOGRAPH MOUNTING

(Patents Pending)

Write or phone for descriptive leaflet to:

NAGARD LTD., 245, Brixton Rd., London, S.W.9

Tel.: Brixton 3550 Telegraphic Address: "Interiel, Claproad, London"

SPECIAL STOCKTAKING OFFER

Resistances, 1 watt, 1/2 watt, 1/4 watt from 27 ohms—3.9 meg.	
An excellent range. Our choice, assorted	15 0
Resistances, Vitreous enamel, 12 watt, 15 and 22K	5 0
Resistances, Vitreous enamel, 6 watt, 10K	5 0
Potentiometers, miniature 330K	
" " 2 meg	3 for 4 6
" " 100K	
Potentiometers, Standard size, 500 ohms, 4K, 2.5K, 25 K	
" " " " " "	3 for 4 6
I.F. Transformers, 1.6 meg. Permeability tuned	per pr 5 0
Electrolytic condensers, 4 mfd., 550 volts, screw mtg.	6 for 9 0
Chrome handles, 4 1/2 in. centres	per pair 5 0
2 Pole, 6-way switch, lin. dia. short spindle	3 for 4 6
Coaxial Plug and Socket, Type 373/P	3 for 5 0
Ceramic Base for TX Final	each 1 6
Ceramic Sub base TX Final	each 1 6
Pye Plugs and Sockets	6 for 5 0
Test Rods Red and Black with leads	per pair 2 6
Epicyclic drives	each 1 6
Single fuse holder with cover	6 for 5 0
Shake proof washers asstd. 6BA and 4BA	per gross 2 0
Single paxolin stand off, Tag Strip	72 for 5 0
Condensers .25 mfd., 600 v.	12 for 5 0
" 10 pfd. Ceramic plus or minus 10%, 500 v	12 for 5 0
" 10 pfd. Disc	12 for 5 0
" 500 pfd. S.M. 350 v.	12 for 5 0
" .005 mfd. Tubular, 1,000 v.	12 for 5 0
" .002 mfd. mica	12 for 5 0
" .001 mfd. mica	12 for 5 0
" .001 mfd. Ceramic tubular	12 for 5 0
" .01 mfd., 1,000 v.	12 for 5 0
" .01 mfd. mica	12 for 5 0

Please quote S.T. when ordering and include sufficient for postage and packing. 1949 Catalogue available, 9d. post free. Shop hours Monday-Saturday 9.5.30 p.m., Thursday, 9-1 p.m.

TELE-RADIO (1943) LTD.

177, EDGWARE RD., PADDINGTON, LONDON, W.2

'Phone: AMB 5393. PAD 6116, 5606.

NEW IMPROVED D.C.-A.C. CONVERTOR

MODEL 231/110. Primarily designed to provide A.C. for such purposes as auto-change radio-grams. This model incorporates many desirable features, including frequency stability to within $\pm \frac{1}{2}$ cycle, efficient H.F. and R.F. suppression, output adjustment for voltages between 180 and 270 D.C., long working life and robust construction. Leaflet available.

£10/15/0

BY VALRADIO LTD.

57 FORTRESS ROAD, N.W.5.

GULLiver 5165

FOR THE EXPERT



MOVING-COIL MICROPHONES

WITH THE PATENTED DIAPHRAGM SUSPENSION

For recording, broadcasting and quality P.A. work, the Lustraphone models cannot be bettered. Send for details.

LUSTRAPHONE LTD.

84 BELSIZE LANE, N.W.3. ●
HAMPstead 5515 and 5389

"Cyldon"

Type No. 16G.

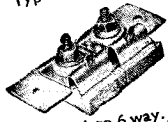

4 to 40pF. 1 to 6 way. 1 1/8" between trimming plate centres. 3/8" between fixing screws. 2 1/2" high.

MICA-DIELECTRIC
TRIMMER
CAPACITORS

SYDNEY S. BIRD & Sons, Ltd.

CAMBRIDGE ARTERIAL RD., ENFIELD, MIDDLESEX
Phone: Enfield 2071-2 'Grams: "Copcity, Enfield"

Technical Excellence

combines with beauty and soundness of DESIGN in the

OXLEY

DIFFERENTIAL AIR DIELECTRIC TRIMMER

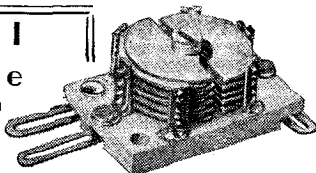

★ Width: 16.5 m/m Length: 25 m/m

Height:

1.5 to 8pF—8 m/m

1.8 to 20pF—12.5 m/m

2 to 26pF—11.5 m/m

2 to 32pF—12.5 m/m

Law: Straight line capacity

Power Factor: Less than .001

Insulation: Over 2,000 megohms

Voltage: 500 D.C.

OXLEY DEVELOPMENTS CO., LTD.,

ULVERSTON, N. LANCs. TEL. ULVERSTON 3306

Rate 3/- for 2 lines or 6.5 and 5.- for every additional line or part thereof, average lines 6 words. Box Numbers 2 words plus 1/-. Press Day: July 1949 issue, first post Wednesday June 8th. No responsibility accepted for errors.

WARNING

Readers are warned that Government surplus components which may be offered for sale through our columns carry no manufacturers' guarantee. Many of these components will have been designed for special purposes making them unsuitable for civilian use, or may have deteriorated as a result of the conditions under which they have been stored. We cannot undertake to deal with any complaints regarding any such components purchased.

NEW RECEIVERS AND AMPLIFIERS

TUNING Units.
FULL range of Denco, Lowther and Eddystone goods available, 5 to 10 waveband gram chassis covering 3 to 60mc/s, 150 to 1,500kc/s, amplifiers for every use, television kits, radio kits, television £51, working at 150 miles range with good results; s.a.e. for leaflet or single items or illustrated 54-page catalogue, price 9d., to Mason's (P.W.), Wivenhoe, nr. Colchester. [3594]

UNIVERSAL ELECTRONIC PRODUCTS, 36. Marylebone High St., London, W.1. Tel. Welbeck 4053.

SPECIALISTS in the design and manufacture of high fidelity reproducing equipment from 4-100watts for domestic or industrial purposes. Our U.E.5 (6watts) and U.E.7 (12watts) series amplifiers are designed especially for the connoisseur who requires the finest possible reproduction from recorded music; both amplifiers have a linear response over 30-20,000 cycles with a damping factor of 12, and incorporate pre-amplifier stage together with independent control of bass and treble. Our policy is to produce an instrument which represents the highest standards in workmanship and performance and no expense has been spared to achieve this object. A new addition to our range is the type U.E.3 (4watts) at £11/10. We also supply a range of tuning units, both t.r.f. and superhet for use in conjunction with either our own or other makes of amplifiers. We should be pleased to quote you for the design and construction of a unit or replacement chassis to your exact requirements. Full details of our products will be forwarded on request, and we would welcome the opportunity to demonstrate our equipment at any time to suit your convenience. [3592]

OFFER Scott Phantom twin chassis and speaker, 10-valve H.M.V. Console, for model 801-800.—Box 5500. [3345]

24-hr. television (not Radar conversion) uses V.C.R.97 tube; send large s.a.e.—T.H. Products, 92, Leathwaite Rd., S.W.11. Bat. 4889. [2472]

HRO Senior coils, speaker, S meter, nearest £22; Clough Brengle sig. gen., r.f. meter, attenuator, 100kc/s-30mc/s, nearest £15.—Bass 155, Green Lane, S.E.9. [3351]

AMPLIFIERS, new 60watt heavy duty p.a. models built for continuous rating and rack mounting, £40; early delivery, send for spec.—Broadcast & Acoustic Equipment Co., Ltd., Tomland, Norwich. [2905]

48/6 brings you the famous Model 30 tuning unit, consisting of 5-waveband Model 30 coil pack, pr. 1.F. transformers, 2-gang condenser and attractive dial, each component individually selected, pre-aligned, sealed and the whole matched together as a unit; the superhet you build with this unit cannot fail to give outstanding performance; "Home Constructor's Handbook," 1/-; stamp for bulletin and catalogue. [3542]

SUPACOLS, 93, Greenway Ave., London, E.17.

WE offer the new "Extended Range" 8-watt control system, giving widest possible variation to suit all old and new recordings; built to instrument standards this 6-valve amplifier, matched to 0.03v input, is now offered at £24 complete; hear it at its best with Tridem Corner speakers and the new Felicity TRF push-button unit.

FELICITY GRAMOPHONE Co., 87a, Upper Richmond Rd., London, S.W.15. Putney 1665

RADIOGRAM chassis A.C./D.C. complete with valves and speaker, separate power pack, 4 wavebands (bandspread on S.W.), fly-wheel tuning, 5-valve Plus Magic Eye made by nationally known radio mfg. of highest repute, very limited number; £16/10 (inc. p.t.); catalogue extra.—N. Reder Assoc. Brit. I.R.E., 221, Hackney Rd., Shoreditch, London, E.2. Tel. Shoreditch 8942. [3564]

C.T.R. ELECTRICAL AND ELECTRONIC DEVELOPMENT, Ltd., Hubert St., Birmingham, 6 (Aston Cross 2440), the Midlands specialist manufacturers of high fidelity equipment for the W.W. Williamson and other quality amplifiers; also tone control stages, load-speaker crossover units, distortionless contrast expanders and radio feeders; see our illustrated advert, in alternate issues of this publication; send for full details and prices. [3503]



Partridge News

NOW AVAILABLE

Hermetically Sealed

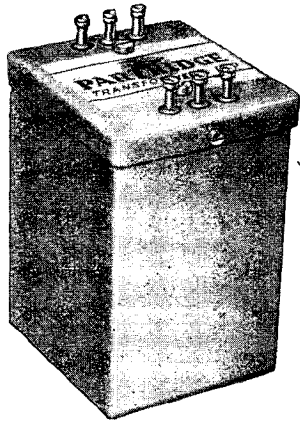

—And in oil if required!

Illustrated is a typical Partridge Transformer (Type DN) in its Mumetal Screening Box. It is merely to remind you that all Partridge Precision Components (standard or "specification" types) are now available as hermetically sealed units.

Then there's the new **PARTRIDGE "PPO" RANGE**

—designed to meet more fully the particular demands of push-pull output transformers where wide A.F. range with low distortion are vital.

FULL DATA ON REQUEST

PARTRIDGE TRANSFORMERS LTD

Roebuck Road, Kingston-by-Pass, Tolworth Surrey

TELEPHONE: ELMBRIDGE 6737-8

1949 bandsread feeder unit with R.F. stage, nine wavebands, 13.5-2,000 metres, 2/6d stamp for illustrated brochure.—Coulphone Radio, Ormskirk, Lancs. [2528]

R.A.F. model 1155 new, complete with valves and 200/10 plus extra power; covers motor, power packs, quality amplifiers, speakers, auto changers and cabinets reduced prices; send for list.—Broadcast & Acoustic Equipment Co., Ltd., Tomband, Norwich. [2906]

CONNOISSEUR'S receiver—world-wide results on highly sensitive 10-valve communication receiver or by change of switch, very high quality reception of local stations on non superhet high fidelity receiver; basis rebuilt R1155 9-1,500 metres; bass and treble controls (boost to cut), gram input, P×4 push pull output, and all refinements.

FEEDER units as above, for use with external high quality amplifiers; write for details or call for demonstration; R1155 specialists, receivers repaired and re-aligned, also modified as above, or to your requirements; R1155 circuit and valves 2/- post free.—R.T.S., Ltd., 5, Gladstone Rd., Wimbledon, S.W.19. Tel. 3503. [1266]

RADIO UNLIMITED proudly announce the R Sandringham portable a.c. mains amplifier, a complete unit for the amplification of voice, radio and records, supplied complete with m/coil microphone, pre-set radio tuner, 10in speaker, etc., housed in carrying case, haffle cabinet, 12gms; full technical data and photographic literature on request; individual components supplied separately if desired.—Obtainable only from Radio Unlimited, 16, Carnarvon Rd., Leyton, London E.10. [3289]

MESSRS JACKSONS (Hammersmith), Ltd., of 171, King St., W.6. Have been appointed agents for the sale of the R.T.M.C. Williamson amplifier; as quality specialists Messrs Jacksons can thoroughly recommend the R.T.M.C. version of this now famous amplifier as being the finest reproducer so far made; built of finest components, first-class workmanship and offered at the right price, a high quality fan should possess one of these amplifiers. 7-valve model, £27/10; 9-valve model with pre-amplifier, £32/10.—Call for demonstration or write for full details. [3025]

R.T.M.C. (EALING), Ltd., pioneers of the Williamson amplifier, are again first with a 9-valve model of this now famous amplifier; built entirely to specification, a 9-valve model combines pre-amplifier and the result is the finest amplifier of superlative quality; offered at the moderate price of £30/10 (cover extra if required) this constitutes the best amplifier bargain to-day; we still, of course, produce our 7-valve deluxe model at £25/10 (ex cover); separate pre-amp at £2/10; H.F. terms as desired.—Write for full details to "Laurie House," 141, Little Ealing Lane, W.5. Ealing 6962. [3518]

FOUR aids to television reception in the provinces: (1) Type AC/2 pre-amplifier now well established as a most effective unit for use with sensitive receivers at very long range, or with normal receivers on the fringe of the service area; price £4/16, complete with self-contained power supply unit, 10gms.

(2) Type AC/3 for the Birmingham area; a pre-amplifier converter unit operating as a pre-amplifier for London, and as a converter for Birmingham, 11 cathode coupled, 1 mixer, 1 oscillator; prices with delivery, 13gms or 8gms without. (3) Type AC/4; pre-amplifier (1 cathode coupled, 1 anode coupled, cathode follower output).

(4) Long range aerial; a compact, well designed 6 element phased array; preferably for use in conjunction with the type AC/4 amplifier.

SPENCER-WEST, Quay Works, Gt. Yarmouth.

MIDCO amplifiers available with rated outputs from 4-25 watts as standard units or up to 75 watts as specified to order; we can offer a prompt reasonable priced service to supply most types of audio amplifiers to specification, enquiries welcomed, nothing too small; standard units, AA/4 4-watt 6V6 amplifier with tone and volume controls, £4/10; AA/10 push-pull 6V6v amplifier with twin high impedance inputs, 10 watts output, complete, £10; these models are supplied on chassis with high gloss enamel cases; larger models in timber cases include £16 push-pull instrument with output of 25 watts, priced at £25; catalogue available; trade terms to bona fide dealers.—Mail orders to 19, Newcomen Rd., callers to 61a, Gt. Park St., Wellingborough. [3021]

NEW Quality radio tuners, suit any standard amplifier; No. 1, L and M wave 2-valve T.R.F. with illuminated dial, glass and escutchion, R/G switch, built and tested, £4/10; in kit form, 75/-; manual only, 3/6; No. 2, 3-waveband 3-valve superhet with large, elaborate horizontal illuminated dial, exceptional range combined with quality; built, tested and aligned, £7/10; in kit form, £3/4; manual only, 3/6; the new N.R.S. quality amplifiers; No. 1, 4watt, pick-up and tuner inputs, volume, tone and feedback controls, 110-250 a.c., built, tested, 119/6, or complete kit, 110/-, or constructional manual only, 2/6; No. 2, 15watts push-pull pick-up and volume inputs, volume mixing, tone control, £7/10; 3 impedance outputs, 200-250v a.c., built amplifier, 10gms or complete kit, 9gms; manual only, 4/6; bargain list, 2/4d; terms, c.w.o. or c.o.d.—N.R.S., 102, Parkhill Rd., London, N.W.3. [3533]

RADIO UNLIMITED, 16, Carnarvon Rd., Leyton, London, E.10, stock use and recommend Vortexion quality amplifiers, from 5-50watt for indoor and outdoor use; also the Sandringham a.c. mains portable amplifier complete with radio tuner and microphone at 10gns. Full detailed list of new and surplus bargains 1d stamp.

RECEIVERS, AMPLIFIERS—SECOND-HAND
G. W. SMITH & Co. (RADIO), Ltd., offers the following sound and perfect:—

TELEVISION receivers, ex W.D. type R3084A, brand new in sealed boxes, using EF50 valves, supplied complete with modification sheet, a cheaper but very good t/v unit, 72/6; R.4709 "Responcer Unit", 10-valve television receiver, with a reception range up to 150 miles; this sounds silly, but we have a client using one at this distance and getting good results. A modification circuit is supplied, price 52/6, limited number only; type 26 U.H.F. units for the Birmingham t/v brand new and boxed, 30/- each; spare diodes for same, 5/- each; chokes, 250ma, 7/6; 8/6, 200ma, 5/6 each; 3/6 each; 100ma, 7/6 each; 6/6 each; 10 henry, 400ma, 9/6 each; transformers 230 input, 1,250x1,250-volt, 300 ma with l.t. winding, 27/6 each; 380x380volt, 300ma no l.t. winding, tapped primary, 19/6 each; 5amp l.t. chokes, 5/- each, nice large core suitable for rewinds; 2,000ohm, 25-volt condensers, 3/6 each; 0.001 5,000-volt test condensers, 1/3 each; 0.002 ditto, 1/3 each; lmfid, 2,000-volt working, 4kv test, 1/6 each; 4mfid, 1,000-volt working, 3/- each; 15pf, 2-gang, 1/- each; 15pf single gang, 6d each; meters, thermo coupled, 0-0.5amp, 0-5amp, 0-4amp, 0-3amp, 2/8 each; 0-5ma m/a, 4/9 each; 0-20amp a.c., 7/6 each; 4-watt television coils, 6d each; 5/6 dozen; Polystyrene, with dust cores, 1/4in formers only, with cores, 6d each, 4/9 doz; No. 18 receivers brand new less valves, 12/6 each; callers only bargains, ex-R.A.F., E.H.T. power packs, type 280, complete with valves, 19/6 each; S.T.C. 30-watt a.c. mains amplifiers, less valves, 45/- each; ex-Admiralty a.c. mains amplifiers, 60-watt output, push-pull, 95/- each; 12-volt cut-outs, 3/6 each; 12-volt starter relays, 3/6 each; mains suppressor units, 3/6 each; E.H.T. sleeving extra heavy lengths, 12-volt vib packs, 5/6 each; 24-volt vib packs, 12/6 each. S. W. SMITH & Co. (RADIO), Ltd., 3, Lisle St., London, W.C.2. Tel. Gerrard 8204. Open all day Saturday. [3566]

FOR sale, Eddystone 504 receiver, home or marine use; £30.—Box 6101. [3474]

R.M.E.69, 10in Rola, in cabinet to match set, good condition; £19.—Box 6227. [3551]

R107 and W1191 with spare valves; offers over £12 and £5.—Box 6080.

AR88, D., guaranteed but non standard front panel, perfect; £25.—Maidenhead 1754.

B.S.R. P.A.10 amplifier, as new; £14.—Wade, 46, Cottage Rd., Leeds 6. Tel. 52363. [3416]

PARTRIDGE 15w amplifier, tuner; £15.—Cooper, 84 Selwyn Av., Richmond, Surrey. [3522]

R1155 power pack, speaker, £13.—Pendry, 76, Ormeau Rd., S.W. [3415]

FOR sale, R208 receiver, 40-60mc/s mains or battery, 3 bands, good order; £10/10.—Box 5457. [3508]

NATIONAL H.R.O. Rx, power pack, complete set 9 range coils, good condition; offers, £10.—Box 6066. [3404]

R.A.I.B. 8-valve communications receiver, excellent condition, with manual, etc.; £15.—Box 6228. [3555]

W.W. quality amplifier, 2-valve tuner with valves; £4.—Davies, Ockbrook House, Ockbrook, Derby. [3464]

HALLICRAFTER'S Skyriver Marine S22R, 8 valves, BFO, switched avc; seen Worthing; offers.—Box 5466. [3323]

SOUND sales, 14-watt amplifier, Goodmans S. Axiom 12, tuning unit; £25.—314, South Lambeth Rd., S.W.8. [3508]

FOR sale, Marconiphone Model T14A, 5-valve superhet table receiver, as new; £25, or offer.—Write Box 6079.

DENCO 6-valve export receiver, 1946, unusual short wave capabilities; £20.—Gilbert, 8a Portinscale Rd., Putney. [3597]

A.R.88 chassis 540kc/s, 32mc/s with instruction manual, perfect working condition; £55, or offers.—Box 6092. [3450]

W.W. amp, phase-splitter oct. 15watt KT66 p.p. n.f.b. pre-amp for m.c. p.u. and radio, bass and treble controls; £26.—Box 6106.

TELEVISION receiver with converted indicator, demonstration; also R1155A converted, mains and 12v battery operated; lot. £20.—Box 5458. [3309]

1155 app. as new, modified 6V6 output circuit and servicing details, no power pack.—Offers, Wilkins, 134, Studley Rd., Redditch. [3592]

A.R.88 communication receiver in new condition, any test with manual; £50, or near offer.—Ullman, 34, Labworth Rd., Canvey Island, Essex. [3422]

N.C.46 American amateur 10-valve receiver, 500-50,000 mc/s, bandwidth, separate 6in speaker; £45.—Dennis, 23, Millway, Mill Hill, N.W.7. Mill. 1853. [3495]

RADIO receiver, the famous AR88L short-wave communication set, ideal for the amateur or short-wave fan.—The Wallanger Co., Hexham-on-Tyne. [3320]



"Oh! Whistle and I'll Come to You"

At last we can announce that the Hartley-Turner Balanced Whistle Filter is ready. This is a very much improved version of our unique pre-war design and is essential for the full enjoyment of radio reception with high-fidelity equipment.

The filter is instantly tunable over the range 6.5 to 11 kc.p.s. and wipes out heterodyne whistles without any audible effect on the transmission itself. The cut at tuned frequency is nearly 50 db. and the "hole" in the response curve is only a few hundred cycles wide. Where can such a performance be even approached by any other device?

The filter can also be used to neutralise resonances in pick-ups, needles and speakers (not necessary in the Hartley-Turner, of course!). Miniature steel needles have a natural resonance at about 9 kc/s and many pick-ups peak at about 7 kc/s. These resonances cause "hard" top, and their ill-effects can be cured by the Balanced Whistle Filter.

The filter can be used in many ways and in various circuits. It is designed for use with all high-fidelity equipment whatever the make. It is compact, completely screened, and suitable for panel mounting; precision made, and will last for ever.

Price £3/18/6, Post and packing 1/6d.
Fully descriptive leaflet free on request.

Trade enquiries welcomed.

**H. A. HARTLEY
CO. LTD.
152 HAMMERSMITH ROAD
LONDON, W.6. RIVERSIDE 7387**

H.R.O. Senior receiver, complete with power supply and preselector, in good condition; £60, or near offer.—Box 6078. [3421]

BC342, excellent condition, 230-110v step-down Xformer supplied, modified as per Q.S.T. instruction books; £15.—Box 6104

R107 communication receiver, 9-valves, 9-17.5mc/s, fitted wave band 200-550 metres (not on standard model); £18.18, or best offer.—Box 6094. [3458]

CR100/2, ten-valve communications receiver, C in perfect order, to maker's specification; £27, or offers.—S. Brewer & Son, Radio Centre, 20, Edgar St., Edinw Vale, Mon. [3401]

H.R.O. Senior receiver, full set, fine H coils, bandspread, 200/250v a.c. pack, strong packing case, purchased new, used few weeks only; £45, or nearest.—Box 6077. [3418]

NATIONAL H.R.O. Senior, power pack, coils. £27/10; Hallicrafters Super Skyriver, SX16, £20; many other items; s.a.e. list, Cross, Skerries, Grange, West Kirby, Cheshire. [3203]

RECEIVERS, A.R.88LF 3515-16-53, 1124D, E.H.T. transformers, condensers, chokes, wavemeters 140-260 mc/s, signal gen. 47 at bargain prices; meters 0-1 m.c. 10/-, 0-3.500v 35/-.—J. Rae, 39, Penn Rd., Wolverhampton.

15 watt gram. amplifiers complete, rack mounting, twin chassis, heavy duty iron core components; 2, PX 25 in pp with valves, £6/15; less valves £4/10, plus carriage.—Broad-cast & Acoustic Equipment Co., Ltd., Tomland, Norwich. [2907]

SALE, as new, Eddystone 640 receiver, perfect condition, owner curtailing amateur activities, £25 or offer; also amplifier, transmitter and power supply, P.A. 807, transmitting components and requirements and offers; will sell lot for £20.—Bangay, R.A.F., Shawbury, Shropshire. [3512]

WILLIAMSON amplifier, as new and unused, condition, commercially built, with Frattidge and Parmec transformers, fitted plug for radio unit, complete with Barker 148A speaker in heavy infinite baffle cabinet, retail value £55; to clear at £27/10.—Weir, S. Ewell House Parade, Ewell, Surrey. Ewell 5404. [3523]

RARE comm. Rx by Telefunken, 1-25mc/s, complete in 5 bands, 110-250v a.c., or 12v d.c. Xtal, bandwidth control, A.U.C./manual, H.P.O. coils, direct freq. reading by optical dial with accuracy equiv. to Xtal; interpolation methods; complete with large supply of spare valves; further spec. on request; £60.—Taylor, 113, Nutwell Lane, Armthorpe, Doncaster.

MOBILE amplifier, 12v d.c. operated, complete with leads, plugs, etc., 45/-; speakers for "Loud Hailer" amplifier re-entrant type, soiled but perfect, 30/-; push-pull carbon microphone, hand type, with switch, supplied with transformer; 10/6; "Loud Hailer" mobile amplifier 12v d.c., 10watts output, for mic and gram, complete with valves, 8gns.

RADIO UNLIMITED, 16, Carnarvon Rd., Leyton, London, E.10. [3545]

CLEAR out bargains offered subject to being unsold; National 1-10 receivers, complete power pack and all coils. £15/10; BC548, fully converted with speaker (black crackle), £12, £25; Peter Pan 4-valve, 2 wave kits, at £9/10; RCA 807s, boxed, 9/-; 1124 receivers, £1/10; sets by famous makers at less than cost; don't delay.—Enquiries with 2/6d stamp to Radio Constructors, 28, Spital Hill, Sheffield, 4. [3161]

HALLICRAFTER SX28 100/250v a.c. 55-43 megacycles, complete with conole cabinet, 12in speaker, circuit diagram, etc., £55. Also a portable auto-radiogram in leather suitcase, a.c./d.c. 200/250v, cost 125gns, in good order, accept £25; Shaftesbury P.A. amplifier, type 8c, complete with speaker and microphone in portable case, a.c./d.c. 200/250v, £12; Trix Ewatt amplifier Model T14, new, mike and gram inputs, tone and volume control, a.c. 200/250v £8/10; Ardente P.A. amplifier, 200/250v a.c. 30watt EL35, push-pull output, mike, gram, and radio inputs, cost 40gns, accept £10, another similar but with pre-amp and mixer unit for 2 mikes and gram, also a suitable radio chassis £20 the lot; Ekco television in beautiful reproduction Queen Anne waxed walnut cabinet all control and speaker concealed, cost £185, as new, accept 100gns.—Box 6082. [3431]

NEW LOUSPEAKERS

WRITE for details of the new Flexicone conversion which considerably improves reproduction of speech and music to existing speakers. Look for Quality Radio, 106, Davidson St., East Croydon. [1923]

THE Tridem 12D Corner cabinet with Barker unit is delighting all customers, price £30; also standard model 12B at £21.—Details from Felicity Gramophone Co., 87a, Upper Richmond Rd., S.W.15. [3492]

SPECIAL high-flux p.m.s. 5in, 11/6; 6 1/2in, 15/6; 8in, 15/6; 10in, 23/6; Truvox wafer, 6 1/2in, 25/-; Truvox, 12in, 45/-; Wharfedale Golden, 10in, 75/-; c.w.o. c.o.d.—N.R.S., 102, Parkhill Rd., London, N.W.3. [3534]

BROADCAST new model pm12 12in die cast frames, Ticonal magnets, 150hm, 12watts, detachable cones, 12,500 lines, standard £5/15; Hi-Fi twin cone £6/10.—Broadcast & Acoustic Equipment Co., Ltd., Tomland, Norwich. [2908]

LOUSPEAKERS, SECOND-HAND

A XIOM, 12in (3 months), as new; £5/5, original packing.—Box 6173 [3525]

WHARFEDALE W12, latest model, as new; £4.-41, Queens Walk, Ashford, Middlesex.

WHARFEDALE W12/CS, £5; Cestelon 10in. 35/-;—Burgoyne, 4, Farnedale Cres., Greenford, Middlesex. [3496]

BARKER 148, used 1 hr. exp., £11.—Cymbryulewicz, 1, St. Stephen's Gdns., W.2. Bay. 0011. [3472]

HARTLEY-TURNER duode de luxe, perfect condition; £5/10.—33, Oakwood Av., Purley, Uplands 6994. [3185]

POST-WAR VOIGT L.C. twin, Lowther power supply; H.C. horn and base chamber; £29/10.—101, High St., Barnstaple. [3561]

QUANTITY of reconed loudspeakers P.M. and energised, 8in and 6in.—Sinclair Speakers, 12, Pembroke St., London, N.1. [3436]

BEAUTIFUL VOIGT cabinet corner horn, inlay mahogany with twin cone unit and power supply; £25.—Telegrams Maidenhead 1754.

BRAND new condition surplus—W.B. Rola and Truxov P.M. speakers, 5, 6, 8 and 10in. at 2/- per inch, post free.—Radio Unlimited, 16, Carnarvon Rd., Leyton, London, E.10. [3291]

VOIGT corner horn (domestic), complete with twin cone unit and power pack, a.c. 200-240v, no output transformer; £26 or near offer; price not including carriage.—Box 6081. [3423]

VOIGT unit, new, with p. pack mounted in h.c. horn (white), £37/10, with Williamson E-25 amplifier, T. con., Voigt P.U., a magnificent record reproducing outfit; the lot, £46.—Box 6097. [3466]

SOUND SALES walnut phase inverter speaker, £9/5; Baker's 12in triple cone, £4/10; Magna 154 2,500 field, £1/2/8; Rola, 8in 6,500 field, 15/-; H.M.V. cabinet P.M., with transformer, £11/16; lists, letters only.—15, Bibury Rd., Birmingham, 28. [3547]

GOODMAN'S Duplex Horn speakers, 4 Ardent 42in horn loud-speakers; 1 EMI tripod stand with cross-bar; 1 Barker 12in speaker (new); 1 Woden 15watt amplifier; 1 Tanhoy microphone and heavy floor base stand (new); 1 Gramplan M.C. Microphone and stand; 1 Universal electric converter, 24v d.c. input, 230v a.c. input, £35amp; 1 E.C.C. converter with filter and silence cabinet, 24v d.c. input, 230v a.c. input, 1.8amp; 1 Briery pick-up; 1 Voigt MC pick-up; 1 Davenset charger, type MGCS.—McKissock, 9, Bruce St., Dunfermline. [3547]

DYNAMOS, MOTORS, ETC.

EKCO CV101 vibrator converter, d.c./a.c., 200-250volts 80watts; £5.—55, Roper Rd., Canterbury. [3465]

E.D.C.C. rotary converter, as brand new, 230 v d.c. input, 250 a.c. 50c output, 300watts, complete in silence cabinet and with filters, cost £43; accept nearest £40.—Spensers & Wyllie, 22, Howe St., Edinburgh. [3229]

ELECTRIC motors—Our famous range of motors again available from stock; example, 1/2hp single-phase, 200-250v, 1,400 rpm. from £6/16/6; send for lists.—John Steel, Bingley, Yorks. Tel. 1066 (4 lines). [3966]

BATTERY chargers, 4 models, 2-6-12v, 1-2-4 amps D.C., 4 mains voltage, also other types, special transformers, chokes, test gear, interior car heaters, etc.—The Banner Electric Co., Ltd., Hoddesdon, Herts. [2212]

BRAND new Onan 400 and 600watt 12-15 coil generating sets, packed waterproof lined cases, complete with spares and operating instructions; ideal for wide variety of purposes; from £25; trade enquiries invited.—R. Evans (Leeds), Ltd., 3, Waterloo St., Leeds, 10. Tel. 29098-9. [3451]

NEW rotary converters with special smoothing equipment for television, radiograms, etc. 300 watts output, £23/10; 500 watts, £30; other converters, various voltages, from £4/10; also new electric motors, a.c. and d.c., B.T.H., Met. wick at list prices; trade supplied; list available.—Johnson Engineering, 319, Kennington Rd., London, S.E.11, Reliance 1412-3. [310F]

NEW Onan pet. generators, 12-15v 60watts (volt. 400), self-start air-cooled 4-stroke, volt. reg., auto, cut-out, ammeter, complete with tools, spares and instruction book, £25 plus carr.; new crated pet. generators, choice of Jap or Villiers engine, 50watts 12-18v air-cooled side-valve 4-stroke (1 1/2hp), complete with control box, cut-out MC meter, toolbox, spares, instruction book and waterproof cover; a first-class heavy duty job, £27/10, delivery free, also Alco-Lyon 12-16v 360watt air-cooled 4-stroke, new or hardly used, with ammeter, cut-out, etc., £16; 4-stroke control boxes for above, new Norman 1 1/2hp ohv engine, Sollex carb., pet. tank, etc., ready to run, £10, del. free; all pet. gens. and engines are tested on load before despatch; send P.C. for lists and illustrations; new shunt dynamos, 14-32v 250watt, not aircraft, £5, del. free; control boxes for above, with cut-out, fuse, var. res. and ammeter, with conn. leads £2/10, p.f.; mains chargers H.D. 50v 50a 3-ect. with control panel, 200/250/1/50 or 440/3/50in, £20 plus carr.; 24v 25a, with control panel, meters, fuses, rheos., 200/250/1/50in £12/10 plus carr.; another, same input, 6-24v 12a, £10, plus carr.

PEARCE, 66, Gt. Percy St., London, W.C.1. See also under components for metal rects., etc.

ELECTRADIX

for Best British Bargains

D.C. DYNAMO BARGAINS. Crypto shunt 35 volts, 35 amps., 2,000 r.p.m., £15/10/-, Crypto 27/32 v., 9 amp., 2,500 r.p.m., £10. G.E.C. Compound, 50/68 volts, 10/8 amp., 1,000 r.p.m., £15/10/-. Mawdsley 240v. 2-amp shunt 2500 r.p.m., £4/10/-. Leeds Neville shunt, 30 volts, 5 amp., 2,000 r.p.m., £2/15/-. 24-volt 30-amp. shunt, 2,000 r.p.m., 40/-, 12-volt, 30-amp., 2,000 r.p.m., 25/-. Carriage extra. C.A.V. 12-volt D.C. Dynamos for Windmill work, 10 amps., 600/1,000 r.p.m. shunt wound, totally enclosed, shaft extension at both ends for prop., new condition, 10 1/2 x 5in. dia., weight 24 lbs., 50/-. Carriage 5/- extra.

D.C. MOTORS, 1/20 h.p., 110 v., 1,400 r.p.m., 25/- each. Mawdsley 110-volt 1/2 amp., 4,000/6,000 r.p.m., £3/10/-. Mevick 110-volt 1/2 h.p., 3,000 r.p.m., £4/10/-.

MOTOR PUMPS, 12 volts D.C., for caravan or boat; lift 3ft. throw 10ft. handle, 100 g.p.h., £5/15/-. Stuart Turner 230 v. A.C., for garden fountains, etc., £6/10/-.

MOTOR BLOWERS, 24 volt D.C., Keith Blackman, 5in. inlet and outlet, 1/2 h.p. motor, £5. **MAGNETS**. New alloy perm. magnets by Swift Levick, instrument type, machined and drilled, useful for polarised Relays, Mirror Galvos., M.C. Meters, electric guitar construction and many other purposes. Circular Horseshoe type, 1 1/2in. dia., 1in. thick, 3in. polar gap, drilled poles, weight 2 ozs., lift 3 lbs., 3/6 each, or four for 10/-.

ELECTRO MAGNETS, 6 volt D.C., weight 10 ozs. double coil, lift 4 lbs., 7/6. **LIGHTING PLANTS**. Villiers Portable Plant, 1 1/2 kW, 35 volts, 35 amp., 2 1/2 h.p. single cylinder 4-stroke engine, with petrol tank, £27/10/-, Carriage extra. Stuart Turner and Pelapone 500-watt 50/70-volt 10-amp. D.C. plant; water cooled, mag. ignition, single cylinder 2-stroke, £40, plus carriage.

VARIABLE CONDENSERS. Large lab. type, oil filled, in glass case, approx. .0005 mfd., with heavy Ebonite knob and scale, 10/-, Carriage 2/-. **CELL TESTING VOLTMETERS**. M.C. Evershed and Walsall, in leather carrying case, 3-0-3 volts open scale, Thistle shape, 15/-, Ohm meters, new Evershed 0-0.1 ohms in wood case with space for battery—clear open scale, £7. Meggers. Evershed vs Megger, 500 volts, 20 megs. Bridge Megger 500 volts 40 megs., with decade Box, £35.

SOLDERING IRONS. New, 110 volts, with flex and plug, 15/-.

HEADPHONES. Moving coil Headphones, 45 ohms 3in. coil, in bakelite case, 5/- each, or 8/6 per pair.

CRYSTAL SETS. The Lesdix Boudoir Crystal Set. Coil wound on bakelite former, variable condenser, semi-perm. detector, bakelite case and terminals, 17/6. Headphones, double with headband and cord, suitable for crystal reception, 5/- pair. Single low resistance Headphones, bakelite case, headband and cord, 2/-, post 6d.

FANS. G.E.C. 24 volt 6in. fan, table or wall fixing for caravan or boat use, white, with blade and guard, new condition, 35/-.

SWITCHBOARDS. 500 watt in metal case, 15in. x 15in., with doors. 5 moving coil meters, 4 variable slider resistances, 3 enclosed cutouts, switches, terminals, etc., £4 ex. Battersea Stores.

FREQUENCY METERS. 250 volt Crompton Parkinson and Nalder, flush panel 1/C needle type, 5in. dia., 45/60 cy., and 320/480 cy., 2in. scale, £6/10/-. Watt meters, Met. Vic. watt meter, 5-30 K.V., full circular scale, 230 volts, 6 1/2in. dia., 3 ph., 50 cy., £5.

TELEPHONES. House and office. Constructors' parts for your own set up. Ex-G.P.O. wall type comprising, bracket mike, transformer and condenser, magneto bell, in walnut case 8in. x 6in. x 3 1/2in., fitted terminals and connections switch hook and contacts, hand magneto generators and single receivers, 35/- per pair, with wiring diagram; carriage and packing 5/- extra.

PARCELS. 10lb. useful odds for the junk box. All clean, dismantled from Government and other surplus apparatus, 7/6 post free. (Not for Overseas buyers.)

Please include postage for mail orders

ELECTRADIX RADIOS

214, Queenstown Road, London, S.W.

Telephone: MACaulay 2159.

CONVERTER d.c. to a.c., 250watts, overhauled by makers, Electro Dynamic Construction Co.; suit large radiogram, £9.—Lee, 40, Avenue Rd., Leamington Spa. [3438]

ROTARY converter for sale.—2 1/2k.v.a., 230 d.c./230 a.c., £40; also heavy duty transformer, various voltages, from 1 1/2 to 440, £5.—Blackheath Film Unit, 9, North St., Leatherhead. [3481]

97/6, charging switchboards, 12v-32v, 500 watts, 1,260 volts, volts, amps, cut-outs, fuses, resistances, etc., a take-offs, superb unit, in case, or send £5 carriage paid; 75/-, dynamos, 24 volts, 1,000 watts, 9in x 7in, 3/4in spindle, or send 80/- carriage paid; 75/-, 230v/150, 1/4hp electric motors, incorporating 1,260 cycle converter, or send 80/- carriage paid; 55/-, mains transformer switchboards, 230v ac to 12v, 5 separate take-offs, complete distribution panel, all switches, fuses, amps, etc., brand new, or send 60/- carriage paid; 55/-, electric motors, 12v and 24v, 1/4hp, 4in x 4in, with 1/2in spindle for drive, beautiful job, or send 60/- carriage paid; 45/-, dynamo units, containing 12v, 24v, 130v and 300v, or suitable at 6v, 12v or 24v motor, approx. 1/4hp, 1 1/2 x 5in, with spindle to take small grindstone, mop, etc., also contain adjustable 24v cut-out automatic voltage control, smoothing condenser, resistances, and many other extremely useful fittings, beautifully made, or send 50/- carriage paid; 45/-, radio valves, adjustment dial, 350-370 Mc/s, beautiful instrument in case, or send 40/- carriage paid; host other valuable equipment; lists free.—Benmotors, Summerley St., Earsfield, S.W.18. Wim. 3833. (100 yds S. Rly. Electric Line; 10 minutes Waterloo.)

TEST EQUIPMENT

R.C.A. Junior VoltOhm electronic test meter, excellent condition; £10.—Box 6229.

TAYLOR meter, model 85A, volt ranges is 20,000 ohms per volt, £15, as new.—Box 6069. [3405]

R.C.A. 100k crystal and holder, lab. precision, stability; £1.—BM/PGS3, London. [3590]

TAYLOR model 30 oscilloscope, scarcely used; £16 or near offer.—Craiton, 8, Abbey Rd., Mansions, N.W.8. [3553]

P.L.I. signal generator, Siemens' test-meter, megger.—69, Lightcliffe Rd., Crosland Moor, Huddersfield. [3552]

AVO 7, £12; valve-tester, £9; osc., £8; the lot, £25; wanted, 'scope, 10watt (or so) amplifier.—Box 6362. [3597]

COSSOR model 359A double beam oscilloscope, Blue Trace, as new, with instruction manual; £55.—Box 6161. [3506]

WESTON E772 20,000 OPV analyser, overhauled by maker's with English adaptors and socket selector; offers.—Box 6160. [3494]

AVO's, as new, d.c. Minor, 65/-; test bridge, overhauled, £9; mains oscillator, £10 or offers.—F. J. Parish, Bovingdon, Herts. [3394]

WESTON model E.772 (type 4), analyser, in good condition, £15; carriage paid.—T. G. R. Dowsett, 48, Grove Rd., Eastbourne. [3497]

FOR sale.—Taylorcraft signal generator, 65A. £8; also utility valves and components.—Chuter, "Nunhood", Boundstone, Farnham, Sv.

L.S.L., combined circuit analyser, valve, and universal testmeter, guaranteed as brand new, 16gns.—4, Granville Rd., Old Hill, Staffs.

AVO oscilloscope mains model, brand new, £10; Valids television pre-amplifier, built constant, brand new, £5/10.—H. Chaudry, Banbury Rd., Bloxham. [3487]

U.H.F. freq. meter, type TS-69/AP, 341-1,000mc/s. absorption type, incorporating 4 1/2 x 4in 200uA meter, Xtal diode (4 spares), complete, in useful transit case, £4/10; also S. generators by Marconi, Ferris, etc.; state requirements (s.a.e. please)—Eldridge, 254, Grove Green Rd., E.11. Ley. 4986. [3509]

100 kc/s-100mc/s, new HF oscillator unit H07-100 ready for immediate incorporation in a signal generator circuit complete instrument supplied, 59/6; also large 9x5in directly calibrated scale matched to unit and all other parts available, stamp for details.—Radio Development Co., Moretonhamstead, Devon. [3497]

OSCILLOSCOPE and Wobbulator complete, £20; T.B. c/s 10 to 350,000 c/s X and Y plate, amplifier, easy to handle, has 2500 ohm impedance, fully guaranteed immediate delivery with set of leads and booklet, "Oscilloscope Technique"; further details from the manufacturers.—Erskine Laboratories, Ltd., Scalby, Scarborough. [3456]

COSSOR impedance bridge, model 3589, as new, £12/10; Avo model 7, as new, £9/10; Avo Minor, £3/10; R.C.A. voltOhm electronic volt/ohmmeter, specification d.c. electronic voltmeter, 6 range, 3-1,000 volts, input res. 11,000,000 ohms, constant, sensitivity 3.666,666 ohms per volt, as a.c. voltmeter, 5 range 0-1,000 volts at 1,000 ohms per volt, as electronic ohmmeter, 5 range, 0.1 ohm-1,000 megohms; movement sensitivity 200 micro-ampers d.c., accuracy +2% of full scale, new with all accessories, £20; American Sark 22 range test meter with accessories, cost £15, accept £7/10.—Box 6083.

GOVT. SURPLUS, UNUSED

CONDENSERS

of all types . . .

We can offer, FOR IMMEDIATE DELIVERY from very generous stocks, a wide range of ultra-high quality fixed paper Condensers, from .001 μ F to 8 μ F. Also STOCKS of small, genuine MICA Condensers from .00001 (10 pf) to .01 μ F (10,000 pf). Prices are exceedingly moderate.

Enquiries are invited for manufacturers' requirements, wholesale and export only for bulk quantities, and for scheduled deliveries over a period, as required.

Most condensers are now available for immediate delivery.

Please request our 4 page bulletin CONSEVEN 01114

CLAUDE LYONS LTD.

180 Tottenham Court Rd., London, W.1
and 76, Oldhall St., Liverpool 3, Lancs.

THE HEART OF A FIRST-CLASS RADIO-GRAM

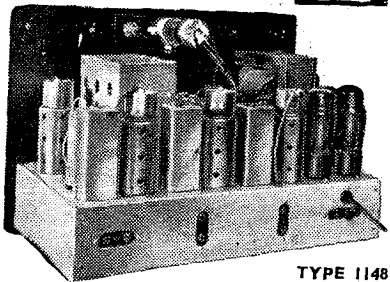

TYPE 1148
Radio-gram Chassis

Developed from the popular type 1047, this receiver will form the basis for a Radio-gram of unsurpassed performance, and at great saving in cost. Principal features include:

- 12 stage superhet circuit
- 11 valves with magic eye indicator
- 4 wavebands (11-2,000 metres)
- R.F. Amplifier
- 2 I.F. stages
- 4 stages AVC
- 10 watts push-pull output
- Separate treble and bass controls
- Tropicalised components

Other Peerless equipment of interest to the enthusiast includes: 10-valve Communications Receiver Type 1548 • R/F Feeder Unit (comprising R/F portion of Type 1148 Receiver) • A/F Unit and Power Switch Type 1. All details on request.

PEERLESS RADIO LIMITED
374 KENSINGTON HIGH STREET, LONDON W.14

Telephone: WESTern 1221

SIGNAL generator, black cross at 45mc/s. sound at 41mc/s, portable, with co-ax. connectors, second-hand, £15.—Boscombe Radio, 585, Christchurch Rd., Boscombe. [3586]

DIAGRAMS and instructions for construction of R. & C. bridge, 2/6; signal generator, 3/-; multimeter, 2/6; valve tester, 3/-; separate component price lists included; test gear in kit form.—L. A. MacLachlan & Co., 16, Thistle St., Stirling. [3515]

METERS.—0-7v, 2 1/2 in, m/c, 9/6; 15v, 2 1/2 in, m/c, 9/6; 150v 2 1/2 in, m/c, 10/-; 300v, 2 1/2 in, m/c, 13/6; 300v, 3 1/2 in, m/c, 20/-; 6,000v, 3 1/2 in, m/c, 27/6; 15,000v, 2 1/2 in, m/c, double reading, 8/-; 30ma, 2 1/2 in, m/c, 6/-; 100ma, 2 1/2 in, m/c, 7/6; 40/120ma, 2 1/2 in, m/c, double reading, 8/-; 3.5amp, 2 1/2 in T.C., 5/-; 4amp, 2 1/2 in T.C. in case with switch, 7/6; 20amp, 2 1/2 in, m/c, 9/6. Meter movements, 2 1/2 in size with magnet and case (50microamp), 2/6; Units containing two movements, 5/-, or with two 100microamp, 5/6. All meters post extra. Ex-R.A.F. 2valve (2volt) microphone amplifiers, as used in plane intercom., in self-contained metal case, can be used to make up a deaf-aid outfit, intercommunication system, or with crystal set, complete with valve, 20/-; United States Patent permanent amplifier, 2/- extra; crystal sets, with permanent detector, 9/6, in oak case, 18/6; headphones, 5/6, 7/6, 10/- and 12/6 pair; permanent detectors, 2/6; soldering irons, streamline, 50w, 9/-, standard 60w, 9/6; heavy duty, 150w, 12/6, all post extra; letters only; new illustrated list sent on request, with 1d stamp and s.a.e.

HIGHSTONE UTILITIES. 58, New Wanstead, London, E.11. [3540]

TRANSMITTING EQUIPMENT

TRANS-RECEIVER TR9, 40-meter band convertible, battery operated 9-valve, require 2v and 120v, self-contained, in working order, complete with valves, £3, less valve, £2 to clear.

R. F. TWEED & DREW, Parson, Exeter. [3566]

HALLICRAFTER transmitters, type HT4E complete to makers' latest specification covering all amateur bands up to 30 mcs, with speech amplifier, connecting cables, etc.; immediate deliveries in quantity, also available, export only. British made Hallicrafter 5X42—Hallicrafter, United Kingdom distributors, McEroy-Adams Manufacturing Group, Ltd., 46 Greyhound Rd., London, W.6. [2778]

GRAMOPHONE AND SOUND EQUIPMENT

M.S.S. disc recorder, in case, with amplifier and output meter; £48.—Box 6075. [3413]

LEXINGTON Junior pick-up, input trans, m.u.

L metal screen instructions, unused; £3/10.—Box 5455. [3305]

H.M.V. hypersensitive and transformer, old pattern, modified armature, 50mv output, £3/5.—Box 6098. [3467]

ARMOUR wire recorder, complete record-play-back, p.a. or s.a., 5 spools wire, full spares; offers.—Box 6172 [3524]

WIRE recorder unit, carrying case, excellent speech or music, play, record, erase, bargain; £40.—Box 6086. [3441]

RECORDING motor, turntable, 78/33rpm; another, 78rpm precision tracker, cutter head; offers.—Box 6091. [3448]

RECORDING blank discs, 12in box of 15

R discs, packed, carr. paid, 35/—G. Lawrence & Co., 3, Slater Place, Liverpool. [3555]

PICK-UPS.—Lescington Senior, 2 sapphires, screened trans, £5; Goldring No. 100, £1, new, or offers.—78 Union Lane Cambridge.

BRIERLEY ribbon pick-up and transformer, unused, sealed in maker's carton, £8/10; Vitavox K12:10, as new, £4/10.—Box 6100.

TRANSFORMERS, tone control and filter chokes for all "W.W." circuits.—R. Clark, 30, Langland Cres., Stanmore, Mdx. Wor. 5321.

SOUND recording by the Direct Disk Method," by D. O.C. Roe, copies available, 5/-, post paid, from Birmingham Sound Reproducers Ltd., Old Hill, Staffs. [2354]

INFINITE baffle corner deflectors, scientifically designed acoustic chambers for 8 to 15in speakers; lists.—Broadcast & Acoustic Equipment Co. Ltd. Tombiand, Norwich. [2904]

REPLACEMENT radio-gram chassis, a.c. mains, 3 waveband, large attractive dial, etc., complete with 8in p.m. speaker, 12gns.—Radio Unlimited, 16, Carnarvon Rd., Leyton, London, E.10. [3292]

NEW condition Collaro auto change, oak cabinet, Sound Sales phase inverter speaker, Sound Sales D.X. plus one feeder unit Wilkins Wright pick-up; £30; buyer collects.—Denny, 94, Eton Ave., Wembley. [3489]

ROTHERMEL de luxe pick-up recently overhauled, £2/17/6; ditto Senior, boxed, £1/17/6; Philips crystal pick-up, £1/15; quantity of popular and swing records; stamp lists; no callers.—15, Bibury Rd., Birmingham, 28.

RAYMAX offer mahogany playing desks fitted with the latest well-known nim drive unit, magnetic pick-up, auto-stop, etc., £6/14/6 incl. p. tax; Collaro rim drive unit, PU auto-stop, etc., £5/10.—Raymax Elec. Co., Ltd., 126, Norwood Rd., London, S.E.24. [3207]

COMPLETE service for rebuilding customers' radio-grams to modern standards, or advice free to those wishing to convert their own sets; we can supply amplifiers, auto-changers, R.F. units, etc.—Felicity Gramophone Co., 87a, Upper Richmond Rd., S.W.15. [3493]

Pennine RADIO

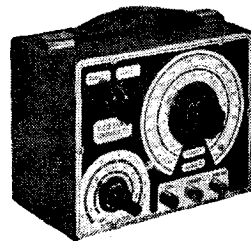

AUDIO SIGNAL GENERATOR

- HIGH STABILITY
- WIDE RANGE 40-16000 C.P.S.
- LOW PRICE
- 3 WATTS OUTPUT

LIST PRICE **£9-9-0**

Write for Particulars

PENNINE AMPLIFIERS
SOUTHGATE, ELLAND, YORKS, ENG.
Tel.: Elland 2107

ETA

FOUR-STATION PRESET TUNER TYPE TS41

A complete preset tuning unit for use in superhet circuits to select any three MW and any one LW station.

Each coil tunes over the whole relevant band by adjustment of its dust iron core. Supplied with full instructions and a complete receiver circuit.

Price **33/-** plus 7/2 Pur. Tax.

I.F. TRANSFORMERS SERIES IT1

A midget high efficiency IFT for 465 kc/s. Both sections permeability trimmed at side of can. Size: 1 1/2" dia. by 2 1/2" high. IT11 critically coupled with top grid lead. IT12 is overcoupled for diode circuits with all connections at base.

Price **7/-** each

PRESET TUNING COILS TYPE V

These coils are exactly as used in the TS41 (with the addition of soldering tags) and are now available for TRF and superhet use. Coverage by permeability trimmers MW 195-530 metres, LW 850-2000 metres.

Price **AE & Osc. 3/6 each.**
H.F. 4/- each.

Obtainable from your dealer or direct from
ELECTRO TECHNICAL ASSEMBLIES
West Hill, St. Leonards-on-Sea, Sussex.

COLLARO a.c.47 motor w. 12in turntable, var. speed, £5; Collaro RP49 motor/pick-up/autostop combined unit, £5/10; Collaro new RC49 a.c. mixed auto-changer with super crystal pick-up, special offer, £14, carr. paid; terms, c.w.o. or c.o.d.; bargain list, 2/3d.—N.R.S., 102, Farkhill Rd., London, N.W.5.

PROFESSIONAL recording equipment, blank discs, amplifiers, microphones and magnetic tape recorders, gramophone motors with non-magnetic turntables; pressings produced from your own masters in any quantity; full trade terms available.—Sound Discs (Supplies), 37, Houghton St., Southport, Lancs. [3466]

RECORDING unit complete, including high fidelity 60watt amplifier, microphone and stand, M.S.S. cutting head and turntable, provision for scrolling, output meter and m.a. meter for output valves, plug for headphones, low and high impedance inputs, speaker in separate case; £75; is not new but is in perfect condition.—Morecambe Sound Service, 4-6, Green St., Morecambe, Tel. 1161. [3595]

SHURE BROS.—Crystal microphone, Model 730A Uniflex, 63db, cost £15; accept £7/18s; Rotomel crystal mike, £4/10; Shaftebury crystal mike, £2; Type C Shaftebury ribbon velocity mike, Type R, £3; Parmeko recording and play back amplifier with 2P×25 in push pull dual microphone gram and radio input, Monitor speaker, German fine quality 2-speed recording motor with Audax cutting head, cost £140, accept £60.—Box 6084. [3433]

MEMBERSHIP of the British Sound Recording Association ensures the professional and amateur recording engineer, and quality reproduction enthusiast, of all the latest information in the form of monthly lectures, publications, demonstrations and the official journal, 'Sound Recording', published quarterly: Vol. 3, Nos. 1, 2, 3 available at 2/6 each.—Details of membership and application form from Membership Secretary Harrie J. King, 48, Mount View Rd., N. Chingford, London, E.4. [2119]

COMPONENTS—SECOND-HAND, SURPLUS SOUTHERN RADIO'S wireless bargains.

LATEST radio publications, Radio Modernisation Manual, 3/6; AC/DC Receiver Manual, 2/6; Using Ex-Govt. Radio Apparatus, 2/6; Radio & Television Laboratory Manual, 2/6; Bulgin Radio Service Manual, 2/6; Radio Calculations Manual, 3/6; Ultra Short Wave Handbook, 2/6; Radio Hints Manual, 2/6; Radio Circuits Handbook, 2/6; Manual of Direct Disc Recording, 2/-; Amateur Transmitters Construction Manual, 2/6; Radio Experimental Circuits Manual, 2/6; Radio Test Equipment Manual, 2/6; Radio Designs Manual, 2/6; Communications Receivers Manual, 2/6; Radio Application Manual, 2/6; Radio and Television Equivalents Manual, 2/6; Loudspeaker Manual, 2/6; Sound Equipment Manual, 2/6; Frequency Modulation Receivers Manual, 2/6; Radio Coil & Transformer Manual, 2/-; Radio Anti-Interference Manual, 2/6; Radio Tuner Unit Manual, 2/6; Radio Constructors' Manual, 3/-; The Waker's Tactics Construction Manual, 2/6; Television Constructors' Manual, 3/6; Inexpensive Television from Ex-W.D. Parts, 1/6; Car & Portable Radio Constructors' Manual, 2/6; Modern Battery Receivers Manual, 2/6; postage on books 2/6d per book, 7.5 mek 1/7s, 7/6 per pair, post in R.F. cartons, 10 mek 1/7s, 10 mek 1/7s, 15 mek 2/0, 20 mek 2/6, 30 mek 3/0, 40 mek 3/6, 50 mek 4/0, 60 ohm headsets, 4/6, post 6d; Lionel bug keys, beautiful condition, 50/-, post 3/6.

SOUTHERN RADIO SUPPLY Ltd., 46, Lisle St., London, W.C.2. Gerrard 6653. [3571]

FRITH RADIOCRAFT, Ltd., Leicester, offer:—

ENAMELLED wire, 14, 16, 18, 20, 22, swg 14/3, 3/-, 1lb 6/-; 24, 28, 30, swg, 1lb 1/3, 12/6, 4/-; 1lb 7/-; 32, 34, 36, 38, swg, 1lb 2, 14/6, 4/-; 1lb 8/-; all prices include reels, postage extra under £1; 25% trade discount to bona fide traders and service men, minimum trade order, £1 net; ebonite rod, ass't. sizes, 6/10 to 3/4 in, 12×1ft lengths, 5/- plus 6d post, or 12×3ft lengths, 15/- plus 6d post; 20 mek 1/7s, 30 mek 2/0, latest streamline type, brand new, in maker's cartons, with 4-way cord and plug, 10/6 plus 6d post; moving coil headphone and mike sets, new condition, 5/- plus 6d post; U.S.A. make luxury headphones, HR type, 2,000-ohms, brand new, in maker's carton, 10/6 plus 6d post; brass terminals, 4BA medium size, captive head, 24 for 5/- plus 6d post; hook-up wire, 72yd ass't. colours, 5/- plus 6d post; telephone wire, twin 7/36 conductors, 36yds, 5/- plus 6d post; lacquered DCC instrument wire 7/36, red, green, black, yellow or ass't., 60yds 5/- plus 6d post; sleeving, L, 1 1/4 and 2mm, 72yds ass't. colours, 5/- plus 6d post; I.F. transformers, 455kc/s adjustable dust cores, 5/- per pr. plus 6d post; rheostats, U.S.A. make, 100ohms or 350ohms, 25watt, wire wound, 2/6 each plus 3d post; satisfaction guaranteed or cash refunded without question.

FRITH RADIOCRAFT, Ltd., 69-71, Church Gate, Leicester. [3539]

C.R.T. 5CP1, with base, screens, in metal cabinet with chassis, etc., magnificent TV foundation; 35/-, post 5/-.—BM/PGSJ, London, W.C.1

ARMSTRONG

Model RF103, Type 2 10-VALVE ALL-WAVE CHASSIS

WITH VARIABLE SELECTIVITY

- High Performance ●
- Outstanding Selectivity ●

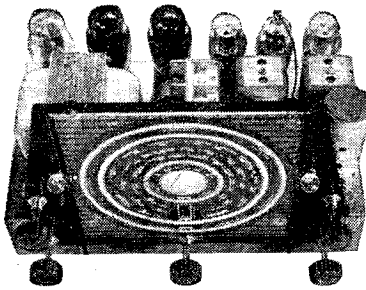

The ever-increasing difficulty in separating stations after dark is apparent to all. Our redesigned Model largely removes this serious obstacle to good listening. The two stages of I.F. amplification with variable selectivity permits of a maximum selectivity better than 6 K.cs. On the short wavebands the actual sensitivity is 8 micro volts. It will be appreciated that this chassis has a performance of an extremely high order, and coupled with the 10 watt output makes, in our opinion, one of the most desirable musical instruments offered to the public. For 200-250v. A.C. mains. Price 19 Gns. Plus Tax.

SPECIAL NOTICE

MODELS EXP 83 and UNI 83. These chassis are being completely redesigned for the coming season and additional refinements incorporated. Advance information will be available shortly.

Model EXP83. 8-VALVE ALL-WAVE RADIO CHASSIS incorporating waveband expansion. Large glass scale. Treble boost control. High quality push-pull output gives 10 watts audio. For 200-250 v. A.C. mains. Price £15. 18. 8. Plus Tax.

Model UNI-83. 8-VALVE ALL-WAVE RADIO CHASSIS incorporating waveband expansion, e.g. the 16-50 m. band covers just over 20 inches on the large glass scale, treble boost control, high quality push-pull output giving 6 watts audio. For 200-250v. D.C. or A.C. mains. Price £15.8.8. Plus Tax.

Model EXP125. 14-VALVE ALL-WAVE RADIO CHASSIS giving continuous waveband coverage from 11.9 m. upwards. Waveband expansion, R.F. Pre-amplifier. Two I.F. stages with variable selectivity. Electronic bass and treble lift controls. 15 watt push-pull output. For 200-250 v. A.C. mains.

Kindly write for illustrated Catalogue
Demonstrations at our Showrooms

ARMSTRONG WIRELESS & TELEVISION CO. LTD.
WALTERS ROAD, HOLLOWAY, LONDON, N.7
Phone: NORth 3213

RADIO CLARANCE, Ltd., 27, Tottenham Court Rd., London, W.1.
SPECIAL clearance offer.—Rec. R.1481; to gain space we offer the remainder of our stock of these well-known receivers, as brand new, in transit cases, complete with valves, tuning meter, 6in s.m. dial, circuit diagram £4/19/6, carr. pd.; receivers, R.U.19, 6-valve straight-run, with 3-1/2 stages, using plug-in coils, H.R.O. type valves 3 X78s, 2 X77s, 1 1642, black crackle case, 15in X8in X8in, supplied complete with valves and 6 coil packs covering 187-305, 281-455, 524-844, 1,285-2,155, 2,960-4,620, 3,865-6,265, 5,075-7,780, 8,750-13,950kc/s £4/10 carr. paid; personal receivers, B.C.722c 7-valve rec. using 14 valves, with 4 push buttons covering 2-6mc/s, supplied as brand new complete with valves, 2 and 12v vib, 2v acc, telescopic ae. etc., £9/9, carr. paid mains trans., all pri. 200/250v. 50c/s, sec. 230-0-230v 100ma. 5v 2a, 6.3v 2a ct, 15/6; sec. 275-0-275v 120ma. 4v 2a, 4v 3a, 13/6; sec. 460v 200ma 210v 15 ma, 6.3v 5a, 16/6; step-down trans., 200/250-110v 60w rating, enclosed, 19/6; smoothing chokes, 5h 120ma 1400/, 5/-; 5h 200ma, 1000/, 6/-; 6h 200ma 1000/, 6/-; 5h 200ma, 900/, 7/6; 15h 200ma, 1500 (6 1/2 X 4 1/4 X 3 1/2), 7/6; 20h 300ma., 1500, weight 13lb (size 7 X 5 X 5), 20/-; electrolytics 8mf 150v, 1/3; 8mf 170v, 1/3; 8mf 350v card 1/9, can 2/-; 8mf 450v, 2/3; 16mf 350v, 16mf 350v can, 2/3; 16mf 500v can, 2/3; 8/3 450v can, 5/6; 16/16 450v can, 5/6; 16/24 450v can, 4/-; 16+32 450v can, 4/-; 32+32 450v card, 4/-; 16+24+8 450v can, 5/-; 8+8+8 450v can, 4/-; 32 450v card W/E, 3/6; 32 450v large can, 2/9; 16+8 500v large can, 3/6; 100mf 3v, 3d; 100mf 6v, 6d; 25mf 25v, 1/3; 100mf 25v single bolt, 1/6; 25mf 50v W/E, 1/3; 50mf 25v 1/6; special lines, 16mf 350v card, 1/9; 25mf 350v card, 1/9; 25mf 350v card, 2/6; 16+24 350v card, 2/6; 3+24 350v can, 2/6; 16+24 350v card, 2/6; p.m. loudspeakers, 5in, less trans, 9/11; 5in less trans, 10/11; 5in with trans, 14/6; 6 1/2in less trans, 13/11; 10in with trans, 25/-, all new; r.f. units, type 24, 8/6; type 25, 10/6; type 27, 16/6, used in good condition, post 1/6 extra; marker beacon rec. G.77, 2 valves (1207, 5/-; 5h 200ma, 1000/ 3 X 1 1/4, with sensitive relay, 8/6 modulators, B.C.456B, with 3 valves 1625, 1245, VR 150/30, new, 13/6; output trans, 2000/2, 2500/2, 2750/2, 3000/2, 4500/2, 7000/40, 3/6; heavy duty 7000/20, 4/6; multi ratio, 7000/3500/1750/20, 4/6; kit for superhet constructors, comprising m.w., ae. and osc., L.W. ae. and 8 1/2 coils (4in formers 1 1/4 in), 0.0005 2-gang conds (standard 1 1/4 in spindle, 1 1/4 in long), 1 pr 465kc/s iron core i.f.s. small size, 17/6, post 1/- extra; ceramic switches, 2p 3w, 1b, 2/-; 3p 3w 1b, 2/6; 3p 3w, 2h 3/-; 2p 6w 4b, 4/6; switches, small size, single bank, 2p 6w, 3p 4w, 4p 3w, all long spindle, 2/-, each switches, standard Yaxley type, 2p 6w, 2/-; 2p 4w 2h, 2/6; 4p 3w, 2b, 2/6; 2p 4w 3w, 2/9; 1p 10w 2h, 2/9, all long spindles; trimmers, 3-50pf, 3.0 on a bar, 1/6; 1-15pf single, 4d; 3-50pf, concentric, air spaced, 6d; 3-25pf U.I.C. type, 3d; air spaced variables, 1 1/4 in spindles, 50pf, 25pf but, terfly, 50pf diff. all ceramic bases, 1/- each; Mansbridge conds, 4mf 1,000v wkg, 2 in packet, 7/6; 2mf radio with 100v d.c. series rec. supplied, 7/-; bakelite cases, 2 1/2in circular, 0/100microA f.s.d. scale meg ohms, 0.4-2.5, 18/6; 0/500 microA, 16/6; 0/30ma, 7/-; 0/50 ma, 8/6 0/100ma, 9/6; 0/200ma, 9/6; 0/15v, 7/-; 100-0-100v 1ma, f.s.d., 7/-; 0/1ma, desk type, 15/-; control units with 2 2in meters, 0/5 ma, 0/40v toggle sw, 5 and 7-pin sockets, 3/6; 12v 4p vibrators, 3/9; visual indicators, cross-over needle with 2 60 microA movements, 5/-; type 3 with 2 300 microA movements and 2 low voltage neons 3/6; s.m. dials, as on R.F.26, etc., less cursor, 4/11; p.m. rotary trans. power units, 12 or 24v input (state which), outputs 250v 60ma, 30v 3a, 6.3v 2.5a. mounted on chassis with supp, 7/6; 10 valve 100-150mc/s receivers, R.23/A, £2.5., 5 valves (inc. 4 717As, 4776), plugs and sockets 7- of 10-pin, with keyway, 1/6 pr; Jones 6 or 8w 1/- pr; transmitter tuning units, Westinghouse type C, 1.5-3mc/s, vario-meter tuned, 15/-; type F 6-9mc/s, condenser tuned, £1; vibrator packs, 6v input, 250v 60ma output size 8 X 4 1/4 X 2 1/4, 15/-; radio compass B.C.433G chassis, less valves, 45/-, carr. paid; panel mounting single fuse holders, 4/6; carbon with sw, 2 1/2in spindle, 5K, 25K, 50K, 100K, 250K 500K, 2m, 5/-; 3watt wire wound V.C., 2000, 4000, 5000, 2.5K, 10K, 20K, 25K, 2/6; 2-gang W/W, 2.5k/2.5k, 3/-; 50K/50K, 3/6; 5000 15w, W/W, 4/-; high res. phones, 4.0000, 5/6 pr; V.F. 0.1 by Wilcox Gay, cover 2-10mc/s, as brand new in original cartons, with accessories, £5, carr. 5/-; Xtal multipliers, brand new in original cartons, etc., 40/-; Admiralty power units, input 24v dc, output 230v 50c/s 75 watts, in grey case 18in X 12in X 12in, with rotary gen. auto trans, 2 1/2in 0-250v meter, d.c. and a.c. switches, output control; sw tch, Slydlock fuses, etc., these units will stand 50% overload, price £3/10, carr. paid. [3572]

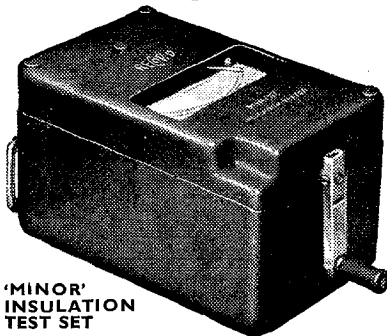

'MINOR' INSULATION TEST SET

Compact and inexpensive without sacrificing accuracy and reliability. Weighs only 5lbs. Height allows for full swing of generator handle. Ranges up to 20 megohms 500 volts.

CONTINUITY TESTER

This latest addition to the Record Ohmmeter range is enclosed in a moulded bakelite case of pleasing appearance. Equipped with self-contained dry battery. Specially designed test spikes and leads can be supplied also a "test and carry" case in which the instrument may be used without removal. Ranges: 0/3—0/50 ohms. 0/50—0/300 ohms. 0/500—0/200,000 ohms.

THE RECORD ELECTRICAL CO. LTD.
Broadheath, Altrincham, Cheshire.
Tel.: Altrincham 3221/2/3. Grams. "Infusion," Altrincham
LONDON : 28, Victoria St. S.W.1. Tel: Abbey 5148

Mr. A. C. BARKER'S NEW 148a SPEAKER

F O R N A T U R A L



R E P R O D U C T I O N

An increasing number of music and radio dealers who realise the rising tide of public interest in good sound quality are demonstrating and selling the Barker 148a. As we have said before, there are several very good reasons why the 148a has in the short space of six months established its commanding reputation for NATURALNESS. These are dealt with fully in a leaflet just printed. It may be obtained from well known firms like Brierley's, Charles Amplifiers, Goodsell of Brighton, London Radio Supply Co., Rogers Developments, Vallance & Davison, Webbs Radio, or from your own retailer, or by writing to:—

BCM/AADU, LONDON, W.C.1

TELEVISION line output transformer, scanning coils, focus coil; 45/- lot.—Woodlands, Cropston, Leicester. [3517]

RADIO and Mumetal surplus strip, .004, .005, .015, 1/8, various widths.—Sinclair Speakers, 12, Pembroke St., London, N.1. [3435]

A MATEUR, selling collection, including meters, components, etc., s.a.e. for lists.—Footit, 61, Bridgewater St., Hindley, Lancs.

D E FLECTOR coils 22/-, focus coil 25/-, for D.W.W. television receiver, instrument wires most sizes.—R. P. Shilton, 19, Clarendon Rd, Salisbury, Wilts. [3522]

D ISPOSAL of radio service workshop, Avo and Taylor meters, electrolytics, transformers, etc., modern components, majority new, at average half retail price; send for list.—Box 6162.

TELEVISION scanning coils, 30/-; frame output transformers, 17/6; line output transformers, 25/-; also mains transformers, chokes, etc.—The Banner Electric Co., Ltd., Hoddesdon.

H.T. transformers (new) for 6.3v vibrators, output 250-0-250v at 80m/a, 10/6 ea. one doz. lots 8/6 ea.; special terms for quantities.—Stewart Transformers, Ltd., 1021, Finchley Rd., N.W.11. [3260]

V.C.R. 97 cathode ray tubes, new in crates, 45/- each, plus 5/- carriage and insurance; send for lists of other surplus and new goods.—Surtees, 81, Malden Rd., New Malden, Surrey. P.O. only. [3522]

T.R.9 transmitter-receivers; these were formerly sold at 45 each, the remaining few to be cleared at 25/-, carriage paid.—The Stamford Radio Co., 199, Stamford St., Ashton-u-Lyne, Lancs. [3040]

H EAVY duty mains transformer 350-0-350 at 120ma, 2, 4 volt windings at 5amps each, 21/-; Midget 100k volume controls less switch, 1/6 ea.—Uncle Tom's Radio Cabin, 5, Seven Stars Court, Manchester. 4.

A MATEUR selling up, for 4s, the remaining few to be cleared at 25/-, carriage paid.—The Stamford Radio Co., 199, Stamford St., Ashton-u-Lyne, Lancs. [3040]

R ESISTORS: New, 1 watt, 2/6 doz.; 5, 3, .75 mags, 4,700, 15,000, 150,000 ohms; also 1/2-watt, 2/3 doz., .5, .2, 1 mags; various types mixed, 2/6 doz.; all 15/- per 100.—Middlehurst, 36, Haresfinch Rd., St. Helens. [3400]

YOU'LL probably get it at Smith's, Edgware Rd.; Everything for the constructor from a 1/10watt resistor to a radiogram cabinet; lowest prices, biggest variety.—Near Metropolitan Music Hall, Pad. 891. [8005]

SELENIUM h.t. and l.t. rectifiers, charger kits, small chargers, etc.; new goods of best quality, not surplus, carefully packed acid postage up to 12/6, 1/4 above; any rectifier up to 1/2kw with correct transformer to order, many types in stock.

S.T.C. selenium rectifiers, latest type, new stock with data sheet, 12-15v 3amp 15/-, 4amp 25/-, 5amp giant finned type 2/6, 6amp 32/-, 10amp 39/6, 8-8v 4amp 15/6, 10amp 22/-, small type 12-15v lamp 10/6, 2amp 12/6, 6v 2amp 9/-, 24-30v 2.5 amp 32/6, 24-30v 4amp 45/-, 24-30v giant finned type 6amp 60/-; trickle charger type, 2v-6v 0.5 amp, 4/10, chargers, 12v 3amp, wt. 13lbs for 220-250v, new goods in handsome black crackle finish steel case, 70/-, 1 5amp, 35/-, 6v 2amp, 12v 11amp, 47/-; all with full guarantee; charger kits, high grade interleaved impregnated trans., S.T.C., 12-15v, 3amp rect., barretter, for 2v to 12v charger, 45/-; ditto with 4amp rect., larger trans., 59/6; specially m/c'd, steel case for above with all small hardware, 19/-, Junior kit 45watt trans., 12-15v 2amp rect. ballast bulb for 2v to 12v, 36/-; Minor kit trans., rectifier, ballast res. for 6v 2amp/12v 1 amp, ultra simple to make, 32/6, or with case and small parts 45/-; heavy duty kit, 140watt trans., 10lb, with giant 6amp rectifier, slider res., ammeter for 6v, 12v charger, 45/- same trans. with 12-15v 4amp rect., fixed ballast res. and ammeter for 6v, 12v, 65/-, or ready for use in steel case 95/-; h.t. rectx., small space selenium 250v 60ma half wave, 7/-; 250v 100ma bridge, 13/6; 450v 40ma, 7/-; 110v 60ma for U.S.A. midgets, 7/-; 110v 20ma elim. type, 7/-; 110v 100ma spkr. field supp., 19/-; M.B.3 instrument rectifier, 3/6; Germanium crystal diodes, 3/9; 0-6amp ammeters flush, 12/6; Rola 8in P.M. spkrs. less trans., 13/6; 80watt fluorescent choke, starter, p.f. condenser, in steel case, 42/6.

CHAMPION, 5, Uplands Way, London, N.21. Tel. Lab. 4457. [3233]

RAYMAX television sound unit, complete kit, using 2, EF50, EBC33, EL33. Chassis punched and main components mounted, price (less valves) £2/17/6, valves supplied at current prices; suitable power pack chassis complete with mains transformer, choke, 8-16mid, valveholder, £1/14/6; Colono rim drive unit, magnetic PU, auto-stop, etc., £5/10 incl. p. tax; Inter. octal moulded V.H. 7/- doz.; all types of components ex stock, including cabinets for TV and table radiograms; our console TV cabinet at £13/15 is worth "looking into." Good photographs of the above designs available (returnable); mahogany playing desks fitted with the latest well-known rim drive unit, magnetic PU, auto-stop, etc., £6/14/6. We welcome enquiries for cabinets to your own specification. Stamp for lists.—Raymax Elec. Co., Ltd., 126, Norwood Rd., London, S.E.24. [3206]

-towards perfection-

History shows, that since our inception in 1932 our aim and policy has been sustained, but with the development of materials and technique we have been able to approach more closely, these high ideals.

P.M.I. Drive Unit, Pat. No. 618,802 and pending, 19,500 gauss, achieved with Ticonal "G" magnetic alloy.

The Lowther Moving Coil Pick-up, the "Pick-up of the age." Licensed under Pat. No. 538,058 and pending, with diamond reproducing point.

T.V. & F.M. has enabled our tuners, amplifiers and speakers a better opportunity to show their finer points.

Modern disc recording; beauty of performance hitherto not possible to demonstrate.

Call and hear for yourself at:—

"The Laboratory Production Unit"

THE LOWTHER MANUFACTURING CO.

Lowther House, St. Mark's Road, Bromley, Kent.
Rav. 5225.

WHY BOTHER YOURSELF WITH A SIGNAL GENERATOR?



48/6

will bring our famous

ALIGNED TUNING UNIT*

In an evening you can have the world at your finger tips.

*For trouble free radio construction critical Radio Men rely on our *Aligned and Sealed Tuning Units*, comprising the famous 3-waveband model 30 Coil Pack, matched 2-gang J.B. condenser, "M.M." I.F. Transformers, 3-colour dial 8" x 6", and free copy of the "Home Constructor's Handbook." This 2/6d. book, which is fast becoming THE book for the discriminating Constructor, is also available to "W.W." readers for 1/- only. Send NOW for your copy mentioning "W.W." Aligned Tuning Unit with R.F. stage available at 7/6. The new J.B. Spin Wheel Tuner assembly can be supplied for 21/9 extra. Send 2d. stamp for list of components.

RODING LABORATORIES
70, Lord Avenue, Ilford, Essex.

10 a mains suppressors, 4 dust coils and condns., 4/6; bridge seleniums, 2d a watt, 24v min., 6p., 24v 1/2; 75ma, 4/4; 750v. wkg. cond. 10+8mfd, 3/9; post free over 5/-; no c.o.d.—69, Allerton Grange Way, Leeds, 7.

SET of Partridge transformers and chokes, in perfect condition, for 50watt amplifier, comprises driver transformer, O.P. 2 times, 15ohms, 2 n.c. chokes, separate l.t. and p.t. transformers, bias, chokes, etc.—Details, Tel. Northampton 1629 after 6 on Tues. and Fri.

E.H.T.1 trans. 2,500 and 2v tropicalised, the best insulation test 8,000v guaranteed, 35/-; E.H.T.2, same plus 4v 37/6; 275.0-275.80ma, 6.3. 5v inter leafed, impregnated, unbeatable value, 16/6.—Hillfields Mail Radio, Ltd., 8, Burnham Rd., Whitley, Coventry. [3579]

A MATEUR giving up radio has for disposal L. radio components, mains, L.F. and I.F. transformers, condensers, resistors, meters, etc., stamp lists; see other adverts. under Loud-speakers and Gramophone, etc.; no callers, please.—15, Bibury Rd., Birmingham, 28. [3549]

I.F.T.s 465Kc 6/- pr.; 3 W.B. coil pack kit L.M.S. with iron cored coils, or M.S.S. 9/6; 8mfd 450v 2/-; 100p.f./100p.f. 2d; electrolytes, etc. 1/- gross; 820ohms tapped droppers 2/3; 50p.f. trimmers 4d; knobs 4d; send for cheapest list in England—Saxex Electronics, Ltd. (G.), 114, Rd. Brighton, Tel. 4446. [3510]

MANUFACTURERS.—Enamel, copper wires all gauges, laminations, all types, huge stocks radio components, s/m, m/m, p/t and block condensers, close tolerance and high stability resistors to 1% at a good guarantee.—E. Simmonds, 63, Byron Rd., Harrow, Middx. Telephones, Underhill 0045, Harrow 0315. [2515]

JACK PORTER, Ltd., for reliable components at very keen prices, boxed 12v vibrators, 1/-; relays, 9d; Sprague 15mfd, 750v working oil block condensers, 7/6; 01 Dubilier mica condensers, 2/6 dozen; moving coil headphones with transformer, and p.a.c. microphone boxed complete 10/-; send for lists—Jack Porter, Ltd. 30/31, College Street, Worcester. [3499]

12 in speaker less transformer, 39/6; all valves at B.O.T. prices; also electrolytics 8 plus 16 450 VDC, 2/6; 16 plus 24 350 VDC, 3/6; speakers, 2 1/2 in, less transformer, 10/-; 3 1/2 in, less 12/6; 9 in less 19/6 with 12/6; 6in, 13/6, with 15/-, 10in, less 19/6; spring lists now available free, trade enquiries invited.—Duke and Co., 219, Ilford Lane, Ilford, Essex.

TELEVISION. Polystyrene and Paxolin formers are now available for the W.W. superb receiver, immediate delivery; also line O.P. trans., scanning and focus coils; comprehensive stocks of Eddystone, Raymart and Denco components; complete set of parts for the Williamson amplifier, 11gns (less valves), s.a. list.—L. F. Hanneley, 77, Lower Bristol Rd., Bath. [3560]

WALTON'S WIRELESS STORES, 203, Staveley Rd., Wolverhampton, for one of the largest stocks of radio and television ex-Government goods in the Midlands; visit our shops at 43, Stafford St., and 65, Trysull Rd., Wolverhampton; you will be amazed at the value we offer; if unable to call, send s.a.e. for our latest bargain list; remember all its carriage free to any address in Great Britain.

THIS month's special, 11ft all steel television aerial masts in two sections, 12/8; or 22ft masts in four sections 22/6; now is the time to fit aerial masts. [3502]

CONDENSERS.—Paper dielectric in rectangular metal cans, 2mfd 500v d.c., and 1mfd 1,000v d.c. in round cans, approximately 1,100 for disposal, radio frequency cable by B.I. Cables, 7/022 and 3/018 low-capacity twin semi air-spaced dielectric cable with star-shaped core, approximately 4,000 yards for disposal also coaxial solid dielectric cable in sizes 1/128, 1/629, 7/032, 1/056.—John Cashmore, Ltd., Great Bridge, Tipton, Staffs. [3331]

CONDENSERS, speakers.—16+16mfd at 500v d.c., at 3/6; 8+16mfd at 450v d.c. at 3/6; 16mfd at 3/-; 0.5, 0.25, 0.1, 0.0001mfd, at 6d; 0.0005 (variable), at 2/-; 0.0005 twin and triple gangs, at 6/6; speakers: 5in, less transformer, 9/6; 5in, with transformer, 12/6; 6in, less transformer, 13/-; 6in, with transformers, 15/-; 8in, less transformers, 16/-; 8in, with transformers, 18/-; 10in, less transformers, 22/-; Duke & Co., 219, Ilford Lane, Ilford, Essex. [2670]

WESTRECTORS, WX6 and W112, clean, unused, 9d each; switches, rotary, 2-bank each, 3-pole, 3-way, 2/3 each, 6 for 12/-; 2-bank each, 1-pole 6-way, no stop, 1/11 each; 1-bank 1-pole 9-way, 2/- each; co-ax plugs and sockets; B7, 7-pin chassis socket, 2d; 2in 1/8 pr. 3 for 4/-; Systerflex 1mm, 15gdr 9pin co-ax polythene, 75ohm, 9d yd; valve holders 5-pin amphenol, 6d; int. oct., 6d; EF50 ceramic 1/-; diode cradle, 6d; BA, 2/-; speakers, Celestion, 2 1/2 in, bargain, as new, high quality, guaranteed, 15/6; Plessey 5in, less trans, 16/6, with trans, 19/-; meters, Best West sockets, 2d; 100p.f., 9/6; San West lma, 2 1/2 in rd., f, m/c, scaled 0-100, 18/-; Ferranti lma, 2 1/2 in rd., f, m/c, 16/-; San West 5ma, 2in sq, f., m/c, 12/6; San West 30ma, 2 1/2 in rd., f., m/c, 10/6; San West 100ma, 2in sq, f., m/c, 12/6; Ferranti 0-500v 2in sq, f., m/c, 1in resistor, 3/8; BA22A receivers, new in makers' cartons, 4v 19/6; superhet and carriage 10/-; also 3084A receivers, new apply for details; c.w.o. only; orders under 30/- add postage; s.a.e. for lists.—G.N. Pill & Partners, 49, Cobourg St., Plymouth. Tel. 2239.

You're SURE to get it at

STERN'S

ESTABLISHED 25 YEARS

Resistances. Special offer. Parcel containing 100 popular assorted values 1-watt type, 8/6 per 100. 1-watt type 11/6 per 100. (Trade enquiries invited.)

M.V. Speakers. Well-known: mfrs. surplus, all 2/3 ohms and P.M. 10in., 23/6; 5in., 17/- (15 ohm, 18/9); 6in., 16/6; 5in., 10/11 and 12/9 (with Transf., 18/6); 5in., 13/9; 2 1/2 in., 14/9. Energised also available in all sizes.

Tuning Cond. (Twin Gang). .0005 mid, ceramic, 7/6 (with Trim., 8/6); .0008 mid, with Trim., 8/6. Midget, .0005 mid, 5/-; Midget, .0005 mid, with Trim., 10/6; Midget, .00035 mid, 1 1/4 in. x 2in., 10/6. 4-Gang, .0005 mid, 5/9; 3-gang, .0005 mid., 7/6.

Coils, T.R.F. Matched pair, M. & L. 6/9. Weymouth ditto, 9/6 pair. S/Het, matched, S.M. & L. 8/9. 10/6 and 11/6 pair. All Weartie "P" Coils, 3/- each, including R.F., B.F.O. and A.F.

I.F. Transf., 455 k/c. New well-known mfrs. surplus. 2in. x 2in. x 1 1/4 in. Perm. Tuned, 9/- each.

Potentiometers. Centralab. 5K, 10K 25K, 50K, 100K, 1, 1 and 2 Meg. less Switch, 4/3. With Switch, 6/-. Midget with Switch, 2, 1 and 1 Meg. 6/-, special 75 Meg., with Switch, 8/-. Electrolytics. B.E.C. Midget Can 4m 450 v., 2/11. 8-8 mfd. 450 v. x dia. x 1 1/4, 4/9; 8-16 mfd. 450 v., 4/11. Dubilier 8 mfd. 500 v. Card. Tub., 4/- T.M.C. 32 mfd. 450 v., 4/9 (and many other types).

Motor Rectifiers. Westinghouse. 0-5 m/a, 4/9 0-10 m/a, 7/6; 0-1 m/a, 10/6.

Selenium Rectifiers. H.T., 15/6; 250 v. 50 m/a 5/9; 200 v. 100 m/a, 5/9; 250 v. 100 m/a, 7/6; 250 v. 300 m/a, 13/9; Bridge Rect., 6 v. 1 1/2 amp., 6/9; 12 v. 1 1/2 amp., 12/6; 12 v. 3 amp., 24/-; 13 v. 6 a., 37/6; 70 v. 1 a., 37/8. Also L.T. 2/12 volts at 1 amp., 3/6.

Wireless World Midget A.C. Mains 2 valve Receiver. All components to build this set as specified in March Issue. Total cost of 23. 0. 0. Reprint of detailed building instructions and circuit, 9d, extra.

Television Transf. E.H.T. 4,000 v. 3 m/a, 2 v. 1 1/2 amp., 45/-; 500-0-500 v. 250 m/a, 4 v. 5 a., 6.3 v. 8 a., 75/-; 350-0-350 v. 250 m/a, 6.3 v. 6 a., 4 v. 8 a., 4 v. 3 a. 6 v. (tapped 2 v.), 2 a., 72/6. 5 K.V. 3 m/a, 2 Volt 1 1/2 amps., 57/6 (also available with v. @ 1 amp.).

Charger Transf. Each has input 230 v., outputs 24 v. (tapped 15, 8 and 4 v.), 3 amps., 27/6; 30 v. (tapped 15 and 9 v.), 3 amps., 25/6; 15 v. (tapped 9 v.) 3 amps., 17/6.

Filament Transf. Input 200-250 v., output 6.3 v., 1 1/2 amps., 9/-. Also with output 4 v., 1 1/2 amps., 9/-.

Export T.M.C. Reed-type Headphones, 70 ohms, 1/9 each (3/6 pair with leads). Single earphones, 75 ohms, with adjustable Headband, 1/6. Midget Output Trans. 32-1, and Parafied Tfr., 4-1, both 1in. x 1in. x 1 1/2 in., 3/- each. P/Pull Intervalve 2.5-1 each half, Output Tfr. 60-1, both 1 1/2 in. x 1 1/2 in., 3/- each. Tangy type Carbon Mike inset, 2/3. Midget Intervalve Transf., 5in. x 1 or 10-1, 3/9 each. Multi-ratio Matching Transf., 4 windings (2 C.T.) over 10 ratios between 10 and 100-1. 2in. x 1 1/2 in. x 1 1/2 in., 3/9. 12 v. D.C. motor suitable for models, 19/6. Moving Coil Mike with 8/R Switch, 2/6. M/C/Coil, Headphone, 2/- Carbon Hand Mike, with 8/R Switch, 2/11. 1 mfd. 5,000 volt Mainsbridge 6/9. 25 mfd 2,000 v. Mainsbridge, 1/6. Throat Mics, 3/6. 5 mfd. 2 kv., 2/- .25 mfd 600v, 1/-.

Garrard A.C. 100/250 v. Gram. Motor with Turntable and Pick-up, Auto-stop, 25 18s. 6d.

Plessey Auto Changer, A.C. 200/250 v., 8 records track, Max. Pick-up, 21S C. 8/5.

Collaro Gram. Motor. Auto Stop, Turntable A.C. 100/250 v., 25 18s. 4d.

L.F. Chokes. Midget 10 Hny. 250 ohm 40 m/a, 3/6. Standard 15/20 Hny. 250 ohm 60 m/a, 6/6. 20 Hny. 300 ohm 100 m/a, 12/9; 5 Hny. 50 ohms 250 m/a, 19/6. 20 Hny. 250 ohm 120 m/a, 16/6.

Coil Packs. Osmer Midget 3 1/2 in. x 1 1/2 in. covers S-M-L Wave, Iron Dust Core Coils, 23/-. Weymouth Standard covers S-M-L waves, 36/6.

Output Transf. Wharfedale Midget 30-60 or 90-1 6/9. Elstone Multi (over 12 Ratios, some C.T.), 6-7 watts, 7/6. Kingsway Multi (same C.T.), 6/9. P/Pull, suit PX4, 61L, etc., handle 18 watts 24/9 (also available in 30 watt type, 30/-).

Moving Iron A.C. Meter, 2in. 0-300 volt, 12/9.

Rotary Transf. New. Input, 230 v. A.C. output 12 v. D.C. 65 m/a, 22/6. Also input 490 v. A.C. output 12 v. D.C. (or 230 v. in, gives 6 v. D.C. out) 19/6.

Send 2d. stamp for very full Stock Lists. When ordering please cover packing and postage.

STERN RADIO LTD.
109 & 115, FLEET STREET, E.C.4.
Telephone: CENtral 5814 and 2280.

SET of four coils, long, medium and short iron cored, 15s. twin gang condenser and circuit 13/6; Pola 5-inch energised 1,000ohm field with transformer, require recentering, 7/6; mains transformer, 230-0-280v.15s 80mills, 6.3volt 3amp, 5v.0t 2amp screened pri. drop thru chassis type, primary input 220 and 240 volts, 13/6; write for lists —Cohen, 67, Ra.e.g. Ave., Hayes, Middx. [2478]

A STOUNDING offer in bargain parcels; each A parcel is guaranteed to contain the following items: condensers and resistances in various sizes; switches; toggle and waxy type, chokes, transformer, microphone, Morse key, potentiometers, bulbs and holders sisterflex, a 24v a.c. motor and a miniature moving coil speaker; the whole parcel sent post free for £1; send cash with order to Bensamson Radio, Dept. W/272, Romford Rd., Forest Gate, London, E.7. Send 1d stamp for list of other bargains. [3439]

RADIO UNLIMITED offer the following selected bargains: Iron core 465 i.f.t.s. 9/- pair; 3 1/2 in P.M. speakers, 2-3ohms, boxed, 10/-; 3in 16/-; ex-Govt. 1 1/2 in m/coil, 4/-; head-phones, new 600hm 4/6, solled 2/6; m/coil 5/6; high impedance, 7/6; 6in. horns, units for flex telephone, 1435 each; 1435 speaker, 6/6; 30/- 100yds; buzzer unit, 4v, 2/3; m/coil mic. v.th switch, 3/6; 0-25amp, m/iron meter, 3 1/2 in 2/11; m/coil, 0-50v 4/6, 0-40amp 3/6; hundreds other lines; full list 1d stamp.—36, Carnarvon Rd., Leyton, London, E.10. [3544]

TELRAD ELECTRONICS, 70, Church Rd., Deptford, New Cross, London, S.E.9.—Condenser, 10pf to 500pf, 8d ea., 6/-; doz; 0.0005mfd to 0.001mfd, 9d ea., 7/6 doz; 0.01mfd 2500v, 1/3 ea., 12/- doz; 25mfd 25v, 1/3 ea., 4mfd 2/6 ea., 8mfd 3/- ea., 16mfd 4/- ea., 32mfd 5/9 ea., all 450v working; latest J.F. dials, 3 1/2 in. x 1 1/2 in., with spin wheel, 25/- doz. New Denco Weartie coils and components; new from stock at keenest prices, all specified components for W.W. and E.E. televisions; state your requirements.—Write, cal or phone Liv. 4879 [3209]

BRAND new condition mains transformer bargains, fully guaranteed, standard drop through chassis type with top shroud and bottom frame. Universal L.T.s for 4v or 5v rectifiers. Screened and un-screened primaries, 250-0-250v 80ma, 16/-; 300-0-300v 80ma, 16/-; 350-0-350v 80ma, 16/-; 250-0-250v 100 ma, 18/-; 300-0-300v 100ma, 18/-; 350-0-350v 100ma, 18/-; 250-0-250 60ma, 6.3v 3a, 5v 2a, 14/6; 250-0-250v 60ma, 4v 4a, 4v 2a, 14/6; fully shrouded upright type, 2/- extra; not Govt. surplus; order your type. C.W. [3545]

DIRECT MAIL ORDER SUPPLIES, 5, Beaumont Rd., Manchester, 21. [3364]

A NEW face and brain? No, we are not plastic surgeons, but we can offer a really attractive 3-way 3-colour glass dial assembly, and the super-efficient Q Coilpack which has earned us so much praise from our customers. An invaluable pair for the rejuvenation of an old set or the construction of a new one. The dial is unique, fitting anywhere, in any position! Price 22/6 complete. Send for full details of these, and other radio and television components, also our latest bargain list. (Trade enquiries invited.)—Osmer Radio Products, Ltd., Borough Hill, Croydon, Surrey. (Tel. Cro. 1220.) [3135]

PANORAMIC reception greatly extends the range of communication or domestic receiving by providing simultaneous reception of all S.W. stations working in any band. Tells at a glance which are C.W. and which phone, also frequency separation and signal strength. The technical excellence and high performance of the Hely-Mann Panoramic Monitor result from extensive developments to a rigid specification. Available completely assembled or as superb kit of parts with elaborate constructional manual. Technical description, circuit and illustrative drawings explain this new development, 3/6d., post free. HELY-MANN ELECTRONICS LABORATORIES, 67, Woodford Rd., Woodford, Essex. [3330]

TELEVISION.—We are manufacturers of approved and tested components for "Wireless World" Television. See view No. 946, issue, and can supply from stock, line output deflector coils, line output transformers, focus coils and shrouds, focus and deflection assemblies correct to designer's specification; complete sets of 21 coils, and filters can be supplied from stock for "Wireless World" superhet television and sound units; television components of all types from stock at current prices.—For particulars, please write or phone "Handytraps," 226, 228, Merton Rd S. Wimbledon. Lib. 7461, near S Wimbledon Tube Station

21- only brings you a Model 30 coil pack, the famous pack which has gained universal renown among amateur and professional engineers for its high quality; spec. 5-wayband superhet pack for 465kc/s I.F., single-hole fixing, iron-cored coils, high stability padders and trimmers, can be supplied aligned for 24/-; Model 40 pack, similar to Model 30, with R.F. stage, 42/- only or 47/- aligned; I.F.s, 10/- pair; matched and aligned outfits as follows: 30-coil pack, 42/-; 40-coil pack, 42/-; 40-coil dial, 48/6; 40-coil pack, pr. I.F. 5/-; 3-gang and attractive dial, 76/6; Home Constructor's Handbook, 1/-; stamp for bulletin and catalogue. SUPACOILS, 98, Greenway Ave., London, E.17.

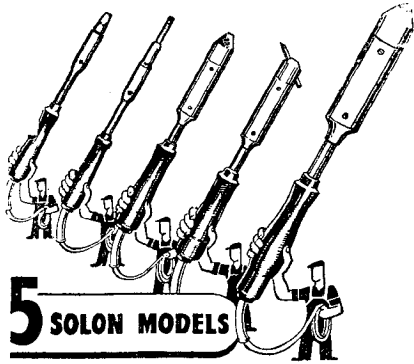

5 SOLON MODELS

SOLON electric soldering irons have proved their capacity for continuous service under the most exacting conditions. 5 models; 240 watt oval tapered bit; 125 watt oval tapered and round pencil bits and 65 watt oval tapered and round pencil bits. Each model complete with 6 feet of Henley 3-core flexible. Now available from stock. Write for folder Y.ro.



W. T. HENLEY'S TELEGRAPH WORKS CO. LTD.
51-53 Hatton Garden, London, E.C.1

OPPORTUNITIES IN RADIO



Get this FREE Book! "ENGINEERING OPPORTUNITIES"

reveals how you can become technically qualified at home for a highly-paid key-appointment in the vast Radio and Television Industry. In 108 pages of intensely interesting matter, it includes full details of our up-to-the-minute home study courses in all branches of TELEVISION and RADIO, A.M. Brit. I.R.E., A.M.I.E.E., City & Guilds, Special Television, Servicing, Sound Film Projection, Short Wave, High Frequency, and General Wireless Courses.

We definitely Guarantee
"NO PASS—NO FEE"

If you're earning less than £10 a week, this enlightening book is for you. Write for your copy today. It will be sent FREE and without obligation.

BRITISH INSTITUTE OF
ENGINEERING TECHNOLOGY
388b, Shakespeare House,
17/19, Stratford Place, London, W.1.

CONTROL A.N.B.3. brand new, contains 4-bank wafer switch, 50 1/4 watt resistances, 4 relays, 1 D.P.D.T. toggle switch, 4 0.5mfd 400 volt and 3 other condensers, 2 M.B.C. lamp holders one with amber glass and dimming device, 2 M.B.C. Mazda bulbs, 12-16 volt, 4 vitreous tubes, 2 var. wirewound preset res., 2 glass-enclosed tetrodes with octal holders in case, 15/-; control B.3A., contains one each 145mfd, 100mfd, 23mfd, 1.000mfd, all 25v working, one 132mfd 30 volt, 1 selenium rectifier, 4 relays, panel mounting L/H with dimmer and 6-8v M.B.C. lamp, 1 D.P.D.T. toggle switch, resistances, knobs, etc., 9/-; Passingham (Dept. W.W.), North St., Keighley. [3580]

New output trans. for small amplifiers, 2 sets of ratios for 6V8s, etc. or 25L6s, KT33s, etc., in P.P. to speaker lines of 1 to 15 ohms; tapped SECS provide ratios from 15 to 50/1 or 25 to 85/1 in 5 steps; pri. sections carry up to 140 m/a; total; ind. over 22 Hs, wgt., over 1 1/2lb; with diagram and 4-hole chassis mounting speaker, panel, 22/-; double bobbin output trans. for 20 w/s; 10-section windings for 5-8-16ohms to 6L6s or specification; wgt. approx. 3lb; ind. over 50 Hs; for above or drop-through chassis mounting; any reasonable ratios provided; delivery less than 7 days, 48/- incl.; 6.5v/2a heat trans. pri., 200-250v; auto-winding not used, no lead wires, with mounted tag plate and diagram, 12/6 incl.
L. H. SMITH (ex-premium apprentice of the British Electric Plant Co., Ltd.), 73, Dunlop St., Glasgow, C.1. [3577]

GEE BROS. (RADIO) Ltd. (formerly Gee Electric), for guaranteed goods at competitive prices. 3 1/2in P.M. 30hms speech coil, ex-famous manufacture, only 9/11; 5in ditto, 9/11; 6 1/2in ditto, 15/11; 8in ditto, 14/11. Miniature 2-gang, 0.005 condenser, with trimmer, with fixing bracket (ex-personal receiver), 9/11; miniature 8mfd 350v all-metal can condensers, size 1 1/2in x 1/2in, 2/6; panel mounting fuse holders, 1/- ea.; single-pole 9 pos 4 bank selector switches (Xaxley type), 5/6 ea.; line miniature pots (ex-personal receiver), 2/6 ea.; ceramic button base, B7G v/holders, 1/- ea.; EF50 v/holders, B9G steartite, 6d ea.; J.50 rectifiers, 400v, 2ma, h/wave, pencil type, 2/6 ea.; many hundreds of other lines. A 2nd stamp will bring latest comprehensive catalogue. Gee Bros. (Radio) Ltd., 15, Little Newport St., London, W.C.2. Tel. Ger. 6794. [3470]

A MAZING radio surplus bargains! Lawrence's, 61, Byrom St., Liverpool, 3, searchlight radar receivers (Elsie), nineteen valves, E84, V21, 6E6, 6MU4 etc. freq. 200mc/s, I.F. 11mc/s, broadband, splendid cabinet, a superb job for long range TV or amateur band conversion, 60/-; American Command receivers, completely modified to 12v medium wave car radio receivers, 6 valves superb, ready to install in your car, complete with speaker, only 27/-; receivers R4/AR2, freq. approx. 148mc/s, miniature valves: 3 6AK5, 7 9001, 1 12A6, similar in size BC453, 65/-; control cables, 7/6; above sets ideal for mobile operation, dynamotors type PE94, these superb American machines, fitted with robust 1/2in shaft, convert to 230v a.c. 1 1/2hp motor, full instructions and diagram supplied, 22/6; filters FL2/15C/870, this well known unit is a genuine bargain at only 8/6; inertia switches, micro action 5/6; control cables for Bendix BC433 and MN26, 7/6; new and unused R.C.A. quality amplifiers 230 a.c., output 20watts, from 1 6J7, 6L6, 1 5U4G, handsome cabinet, £16/5, unused 3cm radar scanning units, AS12/AP53, parabolic reflector, dipole and waveguide, two powerful d.c. motors, precision gearing, 25/-; new American star identification instruments, complete with charts for all latitudes, in leather cases, 5/-; new American box kits M357A, large size, originally intended for elevating 200ft antenna, 15/6; aerial tuning units type 126, rotatable inductance, RF ammeter, tune 2.5-13mc/s, 7/-; Gene-motors, type 33, ideal for car radio, input 12-6v, output 200v, fully suppressed, 11/-; Bendix compass receivers, MN26, valves 1 6L7, 2 8N7, 1 6B6, 2 6J5, 5 6K7, 1 6F6, freq. 150-695kc/s, 3.4-7mc/s, complete with circuits, 90/-; control panels for receivers: RU19, 7/6; BC966/1FF, 3/6; BC453-4-5, 8/6; BC453 dynamotors, genuine plug-on type 28v in, 250v out, 12/6; brand new and unused, in makers cartons, finest quality combination heaters, moving coil meter and earpieces, large rubber ear cushion, 10/-; new M.O.P.A. tuning units CAY47155, freq. 1.5-3mc/s, precision micro vernier dials, ceramic switches, instrument cabinet, 17/6; oscilloscope units BC929, tube 3BP1 3in, seven valuable valves, panel controls for focus brilliance, shift and def. convert to efficient test scope, 70/-; American aerial tuning units BC306A, variometer type S.M. dial, ceramic switch, 11/-; just arrived! a vast consignment of aircraft instruments from 2/6; numerous types for pressure, speed, vacuum, direction, etc., etc.; send only 2/6d for illustrated lists: new Marconi Dynamotors, input 6v, output 200v, 80ma, small dimensions, 18/6; Octal plug-in coils for Birmingham TV, air trimmers, screened, 3/6; new 15h, 100ma chokes, shrouded, 7/-; a 2nd stamp brings you our latest illustrated lists, describing countless bargains from 5kva petrol generators to miniature components; terms, c.w.o., prices include carriage.
LAWRENCE'S, 61, Byrom St., Liverpool 3, Cen. 4430. [3589]

EMPHASIS ON

TECHNICAL

BOOKS

W. H. SMITH & SON give special attention to the requirements of technical men and students.

Books not in stock, but obtainable from publishers, are supplied within a few days. Students' needs for examinations are given priority.

GO TO

W.H. SMITH & SON

1500 BOOKSHOPS AND BOOKSTALLS

TELERADIO.

Radiogram Equipment

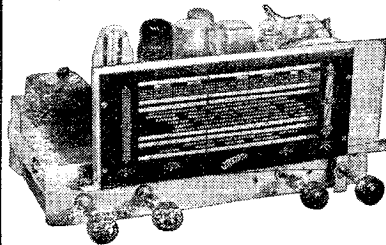

MODEL A70. 6 valve all wave modern superhet chassis with tuning indicator, tone control and radiogram switch. The ideal replacement chassis. £14 14 0d. plus £3 3 0d. Purchase Tax.

MODEL 70 TU. As above but as 3 valve tuning unit feeding model 77 amplifier £8 0 0d. plus 34/10d. Purchase Tax.

MODEL 77. 4 valve push pull amplifier with 2 6V6 fed by phase inverter. Approx. 8 watts output £9 5 0d.

AVAILABLE AS KIT OF PARTS { Blueprints 4/-

Send for leaflet to:

THE TELERADIO CO.,
157, Fore St., Edmonton, N.18

G. A. RYALL. "Utopia," Mayfield Rd., Herne Bay, Kent; mail order only; postage or carriage extra; c.o.d. £1 or over; special list for the trade; U.S.A. tubular metal cased wire ended 0.1m.f. 350v. 6/- doz., 350v 5/6 doz., U.S.A. tubular metal cased wire ended 0.5m.f. 350 7/6 doz.; Mansbridge 1m.f. 500v wdg. 3-2/-; Mansbridge 4m.f. 400v wdg. 2/3 each; silver mica 10 p.f. 40v f. 200p.f. 300p.f. 400 p.f. 500p.f. 6/6 doz.; mica 0.01m.f. 3-1/3; all condensers guaranteed; Amphenol type British 5-pin chassis valve holders, 3/6 doz.; international octal chassis valve holders, paxolin, 4/- doz.; bar type 3-gangs 5/-; bar type 4-gangs 5/-; resistors $\frac{1}{2}$ watt and $\frac{1}{4}$ watt assorted 100-200 ohms to 100,000 ohm assortment 40-5/-; switches, SB, 2P 6w miniature 1/6, 3B, 2P 6w five poles total 2/3 each; SB, 9w 2/-, 2B SP 6w 1/6, SB, SP, 3w 1/-, 2B, 3P, 3w 2/-, SB, 2P, 4w 1/3; twelve-way group boards with 9-1w and $\frac{1}{2}$ w resistances, etc., 2/-, all new; twenty other types in stock; octal plugs, cap and chassis sockets, 3-3/-, with tags 3/6; Paxolin panels $\frac{1}{2}$ in size 12x8 5/6, 12x12 7/8; meters 0-1ma. scaled 0-100, $\frac{2}{3}$ in, $\frac{3}{4}$ in overall 15/6 and 18/6, details on request, first class instruments; metal boxes, black finish with quarter inch paxolin panel, fixing lugs and corner sockets, size $6\frac{1}{2}$ x $7\frac{1}{2}$ x $3\frac{1}{2}$ deep, 6/9 each new; 10,000 ohm life cases; volume controls medium spindle 1/6; metal cased minimum depth $\frac{1}{4}$ meg vols., short spindle 1/6 each; special list for trade. [3485]

GENUINE bargains by post; potentiometers wire wound 1k, 2k, 5k, 10k, 20k, 25k, 2/-; Selenium rectifiers, h.v. type, 375v, 2/5; selenium condensers all can., 16mfid 350v 2/3, 32mfid 350v 2/3; 25mfid 25v 1/3; 16 plus 8mfid 450v 4/-; card. tub. 8mfid 600v 3/9; 2mfid 500v 1/3; 0005 twin gang 7/3; P.M. speakers, $\frac{3}{4}$ in 18/6; 5in 13/6; 8in 16/-; output transformers pentode 4/6; multiratio (6 ratios) 8/6; filament transformers 6.3v 1.5amp 7/6; 3amp 9/-; 20henries 50ma 7/6; 10h 100ma (ex-Govt.) 4/-; 10h 150ma 14/-; 5h 250ma 18/-; volume controls $\frac{1}{4}$, $\frac{1}{2}$, 1meg (with switch) 5/11, ($\frac{1}{2}$ switch) 4/-; 2 1/2d stamp for complete lists; c.w.o. (mail order only); please cover cost of postage and packing.—A.R.K., 4 Queen Square, Brighton, Sussex. [3423]

CHASSIS 16 swg aluminium, undrilled, 10h, 5 1/2in 3/-, 11-6 2 1/2in 3/9, 12-8 2 1/2in 4/3, 16-8 2 1/2in 5/6, 20-8 2 1/2in 6/9; selenium rectifiers, small size, 600v 40ma, 3/6 ea., 36/- doz.; 500v 80ma, 4/9 ea., 48/- doz.; 250v 65ma, 3/6 ea., 36/- doz.; 120-0-120v 40ma F.W. 2/11 ea., 24/- doz.; 120-0-120v 100ma F.W. 3/3 ea., 30/- doz.; 12v 15h H.W. 1/6 ea., 12/6 doz.; 15v 1a C.T. F.W. 5/- ea., 48/- doz.; electrolytics, can 16-32mfid 350v, 3/11 ea., 36/- doz.; Midget 8mfid 450v, tag ended, 2/9 ea., 27/- doz.; ex-Govt. items: 32mfid 450v block electroly, 1/9 ea., 16/9 doz.; 12mfid 50v tubular, 1/- ea., 12/- doz.; 0.5mfid 50v discs, 3.1mfid 1,000ohm tubulars, 0.6 doz. 48/- gross. All foregoing items unused and guaranteed. To clear, 100% only available. R.A.F. 10-valve receivers, type 3003, soiled condition, less valves, 5/6 ea.; c.w.o. or c.o.d. over £1; postage extra; full list of standard components and valves, 2 1/2d; special list for trade.—Radio Supply Co., 5 Queen Square, Leeds, 2. [3572]

NEW STC selenium rectifiers, largest I.T. range in Gt. Britain, all makers' current products, not surplus; selections from our stock: H4/200 for "W.W." television, 28/- p.f.; half-wave 16v $\frac{3}{4}$ a, 6/8; 1a, 8/-; 2a, 9/8; 3a, 6/8; 4a, 10/-; 6d, 18/-; 1p, 10/-; 2p, 10/-; 2a, 14/-; 4a, 26/-; 48v 2a, 21/-; 4a, 35/-; 100v 2a, 34/6; 4a, 65/-; all p. 1/-; H.D. type with 7in sq. Al cooling fins, 16v 5a, 21/6; 6a, 22/8; 10a, 24/6; all p. 10d; 30v 5a, 35/-; 6a, 36/6; 8a, 38/6; 48v 5a, 48/-; 6a, 54/-; all p. 1/-; full-wave bridge conn., 17v 5a, 12/1; 18v 10a, 12/1; 33v $\frac{3}{4}$ a, 21/6; 1a, 21/3; 1.5a, 28/6; 2a, 29/6; 3a, 35/-; 4a, 42/-; 5a, 43/6; all p. 10d; 54v 1.5a, 39/-; 4a, 47/6; 6a, 65/-; 72v 2a, 61/-; 100v 1.5a, 72/-; 136v 4.5a, 168/-; all p. 1/-; H.D. type with 7in sq cooling fins, 17v 6a, 34/1; 10a, 43/8; 12a, 72/-; 20a, 80/-; 33v 6a, 64/-; 10a, 71/-; 12a, 124/-; 20a, 140/-; 54v 6a, 90/-; 10a, 100/-; 72v 10a, 130/-; 100v 10a, 190/-; all p. 1/4; industrial rects., funnel cooled, 17v 12a, 76/-; 20a, 87/-; 30a, 122/-; 50a, 188/-; 33v, 6a, 69/-; 30v 10a, 80/-; 33v 12a, 124/-; 30a, 144/-; 54v 6a, 90/-; 10a, 108/-; 72v 10a, 114/-; 10a, 136/-; 100v 6a, 160/-; 10a, 192/-; all p. 1/6; replacements for valve-type chargers, Philips 328 and 367, Tungar 68504, 68530 and U600, etc., fitted in 5 min without alteration to wiring; tropically rated rectifiers from stock; rectifiers supplied by us are giving excellent service in many countries; specialised rectifier equipment supplied to specification for schools, laboratories and industrial use; kits, trans., rect. and rheo., 33v 6a, £7/10 (incl. tap switch); 16v 10a, 6/12/6; 17v 6a, £4/12/6; both with 10v output tap, following with fused voltage adjuster for 2-6 1/2 tap; 16v 5a, £3/10 (vent. steel case, 7/6 extra); 16v 4a, £3, case, 7/6; 16v 2a, 38/6, case, 7/6; transformers, 200/250/11, 18v 10a, 65/-; p. 1/4; 18v 6a, 47/6, p. 1/4; 17v 5a, 41/6, p. 1/4; 16v 4a, 35/-; p. 1/4; 16v 2a, 25/6, p. 10d; sliders, 1st, all values from 0.6 to 15/-; ammeters, 1r, m.a. 12/6; 0-5a M.C.C. 15/-; both p. 6d; 0-14a M.C.C., 5in dia., 32/6, p. 1/4; see under "Dynamos" for larger charging equipment, etc.; terms, c.o.d. post goods only; c.w.o. or pro forma all others; wholesale and retail.

PEARCE, 66 Gt. Percy St., London, W.C.1; off Pentonville Rd., between King's Cross and Angel. Est. 17 years. [3574]

IT WORKS! What does? OUR TELEVISION of course

The most simple and practical method yet devised of constructing a television using 6in. electrostatic ex-government tubes.

Q. "But does it involve converting government surplus units?"

A. NO. It employs standard radio components, and is assembled from scratch on two chassis, one for vision receiver, sound receiver and time base, the other for power pack.

Q. "Is a knowledge of television technique essential?"

A. NO. This is the main feature of our television, which can be built by a comparative novice using only simple tools with the aid of our easy to follow point-to-point wiring diagrams. A comprehensive set of instructions, wiring diagrams, etc., is available for only 5/- post free.

Q. "And the price?"

A. We can supply the complete outfit down to the last screw for 19 guineas. Each part, however, may be purchased separately as we appreciate that many of you already possess most of the necessary components. Further, considerable economies can be effected by purchasing ex-government Indicator Units, and our staff will be pleased to advise suitable choice.

Q. "How long does it take to construct?"

A. The average person—who can solder fairly easily—should take approx. 30 hours of working time.

Q. "I live in the Midlands, will it work there?"

A. YES. You can construct your receiver now.

Q. "Suppose it doesn't work after assembly?"

A. We shall be glad to check your wiring and alignment for a nominal sum.

Q. "Where can I see one working?"

A. At our London premises, where you will be surprised at its simplicity of design, construction, and outstanding performance. Our greatest achievement and most important 1949 announcement.

FURTHER DETAILS GLADLY SUPPLIED ON RECEIPT OF S.A.E.

Our usual range of Receiver and Indicator Units, high grade components, etc., still available from stock. Send 3d. in stamps for latest illustrated list.

Best buy at Britain's



CHARLES BRITAIN (RADIO) LTD.

11, UPPER SAINT MARTIN'S LANE, LONDON, W.C.2

(3 minutes from Leicester Square Station) Telephone: TEM 0545.

Shop hours: 9 to 6 p.m. 9 to 1 p.m. Thursday OPEN ALL DAY SATURDAY.

FERRANTI 7.5kva moving coil voltage regulator, input 200-250v +8% to 12% 45 to 66 cps. output 200-250v +1/2% frequency compensated, as new and unused, with handbook offered at a fraction of cost price to clear. (Herts).—Box 4299. [2970]

TEST meter panel, comprising a 0-5m/amp and a 0-20v m/c meter, 3 pots, toggle, Yaxley type and stud switches, etc., new and boxed; 12/6 post free.—Radio Unlimited, 16, Carnarvon Rd., Leyton, London, E.10. S.a.e. full list surplus bargains. [3292]

TELEBOOSTER for long range television, type E.F.2, slug and variable tuned, input 40-48m/cs, 2 valve, 3 stage coaxial valves and sockets, size $\frac{5}{8}$ in long, $\frac{2}{3}$ in wide, 2in deep; h.t. and i.t. from receiver chassis, V.R.91 valves (EQ to EF50), gain approx. 30, price £5/12/6; R.F.I. as above but single valve, 2 tuned circuits, type £2/12/6; power units can be supplied, same size as chassis, price £4; s.a.e. for leaflet.—Boscombe Radio, 595, Christchurch Rd., Boscombe, Hants. [3587]

STOP press bargains offered by Radio Unlimited, 16, Carnarvon Rd., Leyton, E.10.—Impedance matching unit for television transmitter, etc. 5/-; miron 0-25 amp meter, $\frac{2}{3}$ in flush mounting, 2/11; miniature 100ohm speaker, $\frac{1}{4}$ in diam, 3/6; extn spkr vol control, 2/-; loud tone buzzer, in bakelite case, 2/3; send/receive microphone units for indoor telephone, 2/- each; twin connecting wire, $\frac{2}{3}$ d yd; heavy duty 5amp panel switches, 9d; sp/st toggles, 1/6. Detailed list stamp. [3503]

H.R.O. Senior receivers complete with valves, crystal and s. meter less coils, £17/10 ea.; few coils available; several other communication sets; R.C.A. crystal cal wavemeters, 250kcs to 25mcs, complete with valves, crystal, phones and instruction book, as brand new, £6/15 ea.; indoor units, type 24, with v.c.r. 37 and 7 valves, brand new, 24 ea., cart. 10/- plus 1d dep. on crate; others in stock; Tannoy 20w P.A. pressure units, as new, £2 ea.; ditto Vitavoxx, £2; elec. light meters, 230v 5a a.c., 12/6 ea.; R.F. units, type 24, 10/- ea., c.p. 24, mod. 27, type 25, 12/6 ea.; type 27, 21/6 ea.; all complete and perfect; most types of W.D. plugs and sockets in stock; wavemeter, Wessex, 4 range, 3-15mcs, 30/- ea., c.p.; signal generators, 100-150mcs, with field strength meter and test meter and batt. box, American, £15; compasses, motors, rotary converters, magnets, klystrons, Elec and radio gear of all types; s.a.e. bring you our 8-page list, including optical gear and lens etc.

H. ENGLISH, Rayleigh Rd., Hutton, Brentwood, Essex. [3393]

SUPREME RADIO, 746b, Romford Rd., Manor S.K., London, E.12. Tel. Hf. 1260. est. 15 yrs. Radio and television components part specialists at the right price.—E.H.T. 4v or 5kv, 2v fl, 55/- ea.; 2.5kv E.H.T. 4v fl, tapped at 2v, 27/6 ea.; line and frame scanning coils, 25/6 ea.; line trans, 21/- ea.; both items matched focus coils, 30/- ea.; h.t. transformer, 350-0-350v, 6.3v 6amp, 4v 6amp, 0-2v, 6.3v 2amp, 250ma, with screen, 70/- ea.; 5kv 250ma choke, 17/6 ea.; 10hv 80ma choke, 9/6 ea.; ceramic E.F.50 valve holders, 6d. ea.; retaining rings for same, 8d. ea.; bakelite E.A.50 valve holders, 6d. ea.; anode clips for same, 2d. ea.; Anti-Corona caps, 6d. ea.; co-axial cable or twin braid feeder, screened 300ohm, 4v, 4/6 doz. yds. only; special offer, balanced feeder 5d. yd., 4/6 doz. yds. only; co-axial plug and socket, 1/- complete; revised edition of E.E. home-built television handbook, 2/6 copy; layout plan and wiring diagram for E.E. television, 3/6 copy; all prices in stock for E.E. television, 4-watt resistances, 100, 220, 270, 470, 820, 1200, 1800, 3900, 8200, 2.2k, 11k, 39k, 47k, 100k, 10k, 1/9 doz., 18/6 gross only or assorted; $\frac{1}{2}$ watt resistances, 1000, 1500, 2000, 4000, 5000, 2k, 2.2k, 10k, 16k, 18k, 20k, 150k, 500k, 1.5m, and 5meg, 2/- doz., 21/- gross, or assorted; most other values at 3/- doz., 30/- gross only; 1 watt resistances, 470k, 1k, 3.3k, 8.2k, 18k, 33k, 56k, 75k, 82k, 100k, 1m and 2meg, 4/- doz., 45/- gross only, or assorted; 2 watt resistances, 2k, 18k, 1m, 5/6 doz., 60/- gross only; main transformers, 350/0/350v 120ma, 6v, 5v and 4v, 32/6 ea.; metal tubular midget tap-end condensers, 25mfid 25v, 1/2 ea., 13/- doz.; 50mfid 50v and 50mfid 12v can-type condensers, 1/- ea., 11/- doz.; 0.01mfid 1,000v, 0.02mfid 750v, 0.05mfid, 500v and 0.1mfid, 350v, 5/6 doz.; 0.1mfid 500v, 5/6 doz.; midget mica condensers, 0.001mfid, 0.002mfid and 0.005mfid, 5/6 doz.; metal mica condensers, 0.01mfid 350v and 0.002mfid 500v, 9d. ea.; 8/6 doz.; can-type condensers, 8mfid 450v, 2/9 ea.; 16+32mfid 350v, 4/3 ea.; 16+8mfid 450v, 4/3 ea.; 30+30mfid 350v, 425v surge, 6/6 ea.; 16+24mfid 450v, 5/6 ea.; 32mfid 350v, 3/- ea.; 32mfid 500v, cardboard electrolytic condensers, 6/6 ea.; 16mfid metal can electrolytic condensers, 350v, 1/9 ea.; midget can condensers, 16+8mfid and 8+8mfid 450v, 3/9 ea.; 16+16mfid 450v, 5/6 ea.; 8mfid 450v, 2/6 ea.; 4mfid 550v screw base tubular metal condensers, 1/5 ea., 14/- doz.; 0.01mfid 5kv metal tubular condenser, 3/6 ea.; 2mfid 350v metal and cardboard wire end electrolytic condensers, 1/- ea., 11/- doz.; fixed mica condensers, 3pfd, 30pfd, 60pfd, 65pfd, 70pfd, 180pfd, 305pfd, 307pfd, 500pfd, 570pfd, 590pfd, 700pfd, 4,550pfd, all at 2/6 doz., or assorted doz., 25/- gross; 0.01mfid 3kv and 0.005mfid mica, 3kv and 1.5kv mica rectifiers, selenium type, 230v R.M.S., 120ma, 4/- ea.—Terms, c.w.o., no c.o.d.; send 6d. extra for postage orders under £5; 2 1/2d. s.a.e.: all enquiries and list. [3569]

SOUTHERN RADIO'S WIRELESS BARGAINS ALL POST PAID

RADIO COMPASS INDICATOR DIALS. Complete with Selsyn motor. Ideal for loop indicators. Small size 3in. dia. 360 degree dial, 13/6. Large size 4 1/2in. dia. with adjustable 360 degree dial, 15/6. Both sizes in makers sealed cartons.

CONTACTOR TIME SWITCHES. Made by Vanner or Smiths. 10 hour clockwork movement giving two impulses per second. Ideal for Darkroom work. In paxoline soundproofed boxes. Brand new in makers cartons, 11/4.

BC454 and BC455 Six Valve Receivers, 3-6 mags. and 6-9.1 mags. respectively. 12SK7 (3), 12SK7 (1), 2A6 (+) and 12XK4 (1). Ideal for car and portable AC/DC receivers and converters. Brand New in makers sealed cartons, 36/6.

CONTROL BOXES FOR BC453/4/5 RECEIVERS. With three slow motion dials and drives three 50,000 ohm vol. controls and six rotary switches. Brand New in makers sealed cartons, 13/6.

CONTROL CABLES FOR BC453/4/5 RECEIVERS. 14ft. long, 9/6.

DIRECT DRIVE ADAPTORS FOR BC453/4/5 RECEIVERS. Gives full slow motion drive. 3/-.

FOURTEEN FOOT COPPER AERIALS. In seven sections, 5/-.

BASES for 6ve, 3/-.

CAR RADIOS Converted from BC454 and BC455 receivers. Medium Wave Coverage. 6 valves for use of any 12 volt supply. Complete with speaker and power pack. 46.

DELCO HAND GENERATOR. 6 volt 4 amps. Brand new in maker's cartons, 17/-.

INDICATOR UNITS R3023A. 3EP1 tube 2 1/2in. dia. non persist. Valves 9X2 (1), 6X5GT (1), 6H8 (2), 6G6 (1) and 6SN7 (2). Switching motor, etc. In black crackle finished case. 45/-.

LUBBRA HOLE CUTTERS. Adjustable to 3 1/2in. dia. 5/6.

THEROAT MICROPHONES. Magnetic. Low impedance with three foot lead and jack. 3/6.

WESTELECT W.X.8 and W.112. 6/4 per dozen.

M.C.R.I. BATTERIES. 90 volt h.t. and 7 1/2 volt l.t., 7/3.

MINIMAX 67; VOLT BATTERIES, 5/10.

Southern Radio Supply Ltd.
46, LISLE STREET, LONDON, W.C.2
GERrad 6653

TRANSFORMERS & COILS TO SPECIFICATION.

MANUFACTURED OR REWOUND
Filter Coils + 1% a Speciality.

JOHN FACTOR LTD.
9-11 EAST STREET, TORQUAY, DEVON.
*Phone: Torquay 2162

COILS and PACKS for WEST COUNTRY CONSTRUCTORS

ATKINS. Fully trimmed and padded.	
OS.1.—Mixer Input, L. M. & S. Bands	£2 9 4
OS.2.—" " " " " " " " " " " "	£2 9 4
HF.1.—H.F. Stage L. M. & S.	£4 0 1
HF.2.—" " " " " " " " " " " "	£4 0 1
CCP.1.—A Six Band Communication	£8 11 10
Pack covering 5 metres to 2,000	
DENCO. High efficiency tuning turrets	
having polystyrene coil formers and	
complete with tuning condensers, knobs	
and dials.	
CT.6.—Mixer input, 5 Bs, 10-2,000 m.	£6 0 9
CT.7.—As above with H.F. Stage	£8 13 0
Drilled Sub-Chassis for CT.6 and CT.7	12 6
CT.4.—The improved DENCO 6-band	
communication turret covering 8.5-	
1,700 metres, with band spreading on	
5 amateur bands	£12 14 11
CT.4C.—As above with completely wired	
Sub-Chassis	£15 16 10
CT.4/SW.—As CT.4, with the broadcast	
band omitted	£9 6 0
WEARITE. With dust cored coils.	
605E.—Mixer Input, L. M. & S. Bands	£2 11 4

G. N. PILL & PARTNERS
49, COBOURG STREET, PLYMOUTH
Telephone : 2239

LITTLEWOODS.—H.T. rectifiers, selenium. 270v 75ma, 6/-; 250v 40ma, 3/6; J.50. 400v 2ma pencil rectifiers, 3/-; Germanium crystal diodes, super cold valve diodes for detector; a.v.c., etc.; ideal for crystal sets, 6/-; post extra all items.

G. HENSON LITTLEWOOD & Co., 27, Ballards Lane, Finchley, N.3. Fin. 3060. [3567]

CONDENSERS. Midget, 0.1mfd, 150v. d.c. wka, 1/3 doz., 9/6 100; chassis M.t.a. metal, tubular, 0.25mfd, 500v d.c., 5/- doz.; single pole chassis mounting fuse holders, 6/- doz.; selection components; enquiries invited.—3, Western Drive, Shepperton, Middx. [3531]

WANTED, EXCHANGE, ETC

AVO No. 6 winding machines wanted; details and price.—Box 6178. [3542]

WANTED Tuner unit for W.W. amp.—Deaconman, 6 Abingdon Rd., Kensington, W.8. [3490]

WANTED immediately, Cambridge instrument dynamometer test set, must be in good condition.—Box 4764. [3064]

WANTED, small quantity screened multiway cables, fitted W-pugs, particularly 12 and 18 way.—Box 6155. [3490]

WANTED.—Dinghy transmitters, T.1335 or American equivalent; state quantity, condition and price.—Box 6099. [3469]

WANTED Surplus relays and push-button units, any condition, large or small quantities; highest prices paid.—Box 6190. [3532]

VACUUM Hg. also Pyrex domed chamber suitable blooming; no fancy prices.—Box 6072. [3490]

WE pay top prices for used test equipment, all types.—University Radio, Ltd., 22 Lisle St., London, W.C.2. Tel. Ger. 4447 and Ger. 8582. [3592]

WANTED, circuit diagram and/or service sheet for Ferguson 378, universal or a.c.—Write Major Richman, c/o 23 Heavy Workshop R.E.M.E., B.A.O.R.14. [3447]

CARRIER telephone and telegraph equipment of all types in any condition wanted; also teleprinter and teletypewriter apparatus.—Harris & Gilrow, 83, Wardour St., W.1. [3303]

WANTED, all kinds of test equipment, signal generators, oscilloscopes, bridges, etc.—Send details to Pike Bros., 86, Mill Lane, London, N.W.6. Tel. Hamstead 4219. [3453]

HM.V. and Marconi radiograms wanted, for cash, top price offered, for auto-change models.—Please send model No. and parties, to Stockwell, Radiogram Specialist, Ilfracombe. [3270]

WANTED, F.M. pack transceiver SCR 609 A or SCR 609 B or SCR 610 (BC 659); coils or crystals, two antennae AM-42-A and instruction book for F.M. transceiver (vehicular) SCR-295-A (BC-499-A and BC-500-A/B, Fred M. Link).—Box 5451. [3270]

WE buy for cash, new, used, radio, electrical equipment, all types; especially wanted, radios, radiograms, test equipment, motors, chargers, recording gear, etc.—If you want to sell at the maximum price call, write or phone to University Radio, Ltd., 22, Lisle St., Leicester Sq., W.C.2. Ger. 4447.

REPAIRS AND SERVICE

MAINS transformers rewound, new transformers to any specification.

MOTOR rewinds and complete overhauls; first-class workmanship, fully guaranteed.

F.M. ELECTRIC Co., Ltd., Potters Bldgs Warsley Gate, Nottingham, East 1917. Tel. 5455

LLOUDSPEAKERS and transformers rewound, cones replaced, prompt service.—Dodd, Radio Service, 131a, Hurst St., Oxford. [3321]

LLOUDSPEAKER repairs, British, American, L any make, moderate prices.—Sinclair Speakers, 12, Pembroke St., London, N.1. Telephone 4355. [3508]

MAIN and output transformers rewound to pattern or specification, return post service.—H. Pughe, Radio Rewind Service, Brithdir, Nr. Dolgellay, N. Wales. [3243]

REWINDS and conversions to mains and output transformers, from 4/6; pp. equipment a speciality.—N. L. Rewinds, 4, Brecknock Rd., N.7. Tel. Arno'd 3590. [6283]

MAINS transformers rewound or constructed to any specification; prompt delivery.—Bede Transformer Co., Ltd., Bedesway, Bede Trading Estate, Jarrow. [3198]

AREWIND service which duplicates or modifies as required; transformers, loudspeakers, etc.; prompt returns.—Raidel Services, 49, Lr. Addiscombe Rd., Croydon. Cro. 6557.

EVERY make of electrical measuring instruments repaired and standardised.—The Electrical Instrument Repair Service, 329, Kilburn Lane, London, W.9. Tel. Led. 4168. [2527]

RADIO MAINTENANCE SERVICE for guaranteed rewinds and repairs; armatures, F.H.P. motors vac units etc.; good deliveries.—139, Goldhurst Terrace, N.W.6. Mai. 6133.

"SERVICE with a smile."—Repairers of all types of British and American receivers; coil rewinds; American valves, spares line cord.—F.R.I. Ltd., 22, Howland St., W.1 Museum 5675. [1575]

REPAIRS to moving coil speakers, cones, coils fitted, field rewound or altered; speaker transformers, clock coils rewound; guaranteed satisfaction, prompt service; we do not rewind mains trans.—Closed Sat.

L.S. REPAIR SERVICE 49, Trinity Rd., Upper Tooting London, S.W.17. Balham 2359.

LET'S GET ON WITH IT

Now that the chancellor has done his worst, it's good to know that A.W.F. still give satisfactory (and speedy) service, to all radio dealers and service engineers,

WITH
Good stocks of Tunggram valves, T.C.C. condensers, Erie resistors, Egen volume controls, and all those fiddling little lines, that are difficult to handle

AND
Loudspeaker repairs, Transformer rewinds, etc., T.V. TRANSFORMERS, CHOKES, etc.

Radio dealers and engineers (R.T.R.A. definition) are invited to send I.d. stamp for the latest Monthly Bulletin.

A.W.F. Radio Products Ltd.
(Dept. W.)
Borough Mills, Bradford, Yorks.

Build a 4 Watt Amplifier

Level from 30 to 15,000 cycles. ADJUSTABLE feed-back.
For full frequency range recordings, high fidelity radio or microphone. Complete Kits £6/17/6.
Data sheets 2/9 post free.
Cestation P.44. 3 ohm, 10 watt speakers 75/- post free.

Alan Brown Recording Studio
35, Arundel Street, Portsmouth.



QUARTZ CRYSTAL UNITS

For—
AIRCRAFT, MARINE AND COMMERCIAL USE are available in the complete range from 35 kilocycles to 15 megacycles.

Alternative mountings in standard two-pin A.M. pattern 10X, International octal, and miniature type FT243, can be supplied for most frequencies.

Prices are fully competitive, and we specialise in prompt deliveries for urgent requirements.

WE WELCOME YOUR ENQUIRIES.

THE QUARTZ CRYSTAL Co., Ltd.
63-71 Kingston Road,
NEW MALDEN, SURREY
Telephone : MALden 0334

AMAZING BARGAIN

Ex. M.O.S.
NEW &
UNUSED
ELECTRIC MOTORS

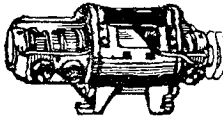

A.C. single phase, approx. one-sixth h.p., for 200/250 volts, 50 cycles. They're worth £'s. Dimension 11 1/2 in. long x 5 1/2 in. x 5 in. Weight 16lb., shaft 3/8 in. x 1 1/2 in. Keyed ready for pulley. Vee Die Cast Pulley 3 1/2 in. O.dia. Supplied at 7/6 extra. Post Free.

25/-
plus 5/-
for carr.
&c.

MOVING COIL
HEAD &
MICROPHONE
SETS (Brand
new)

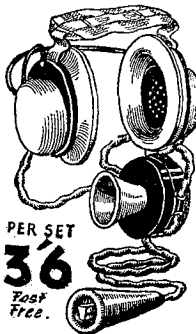

Made by the same famous maker, these units must have cost the Government many pounds.

Our Bargain Price

PER SET
13/6
Post
Free.

Send stamped address-
envelope for illus-
trated list.

BARGAIN

WIRELESS INSTRUMENTS (LEEDS) LTD.
54-56, THE HEADROW, LEEDS 1.

Tel. 22262.

SPENCER - WEST TELEVISION PRE - AMPLIFIERS

are now available for
immediate delivery

Available on seven days' free trial

See classified announcements p.61 for details

SPENCER - WEST, NORTH QUAY
GT. YARMOUTH

SHORTHORN

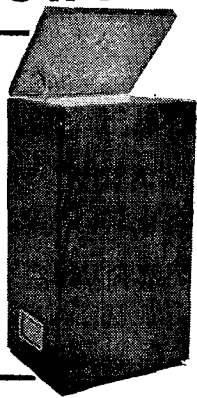

—not referring to a certain breed of meadow lady, but to the upper half of the IAN BAILEY REPRODUCER Series 2 (as photograph) which, in conjunction with a special reflector and the open lid, ensures a wide distribution of H.F.s up to 18K c.p.s. The bass down to approx. 30 c.p.s. is well looked after by a separate labyrinth in the lower half.

PRICE £33

with unit

ELMSLEIGH RADIO
COMPANY

LEIGH-
ON-SEA
75168

1102 London Road, Leigh-or-Sea
ESSEX

BOOKS (advanced) on radio, science, maths. and engineering, for sale; also many magazines.—Betts, 19, Wychnall Lane, Birmingham, 30.

LUMINUM chassis and panels, all sizes manufactured quickly, holes punched for valveholders, etc.; crackle and cellulose finishing.—E.A.D., 18, Broad Rd., Willingdon, Sussex.

CHASSIS, panels, racks and metal cabinets, stock sizes or made to specification in steel or aluminium; wrinkle finishes available.—Reesound Engineering & Electrical Company, Cheshill Rd., Sutton Coldfield. [3409]

SPARKS' data sheets provide complete constructional details and full-size draughtsman-prepared prints showing drilling, assembly and wiring plans of tested and guaranteed designs by L. Ormond Sparks.

LATEST release.—The Challenger portable, an ac/dc 3-valve (plus rect.) T.R.F. circuit having an exceptional performance on med. and long waves, the ideal set for radio in any room, no aerial or earth; 6in Stentorian speaker gives amazing power and quality; no complicated changing or adjusting. **SENTS 2/9**

COMPONENTS can now be supplied; send a stamp for list giving full details of the 34 designs available.

SPARKS' DATA SHEETS (W.), 9, Phoebeth Rd., Brockley, S.E.4. Tel. Lee Green 0220.

RADIO supervisors and technicians should join their appropriate trade union, the Association of Sound Engineers, Executives and Technicians.—Write for free pamphlet to ASSET, 110, Park St., London, W.1. Tel. Mayfair 8541-2.

FLUORESCENT lighting, kit of parts, 40-watt tapped, shrouded choke, 200-250v a.c., p.f. condenser, glow starter, Bi-pin holders, terminal block, suppressor and circuit; 5/1/9; buy your 4ft tube locally.—Malden Transformer Supplies, 20B-20D, Sandridge Rd., Norbiton, Surrey. [3507]

RADIOGRAM cabinets, £18; also communication receiver cabinets to take standard 19in panel, in highly polished oak, 45/-; extension speaker cabinet to match, 25/-.—Send for illustrated leaflet to Cabinetware, Summitt Works, Heyes St., Blackburn [3578]

COPPER wires enamelled, tinned, Litz, cotton, silk covered, all gauges; BA screws, nuts, washers, soldering tags, eyelets; ebonite and laminated bakelite parts, tubes, coil former; Tufnol rod; headphones, flexes, etc.; latest radio publications, full range available; list s.a.e.; trade supplied.—Post Radio Supplies, 33, Bourne Gardens, London, E.4. [1454]

SITUATIONS VACANT

Vacancies advertised are restricted to persons or employments excepted from the provisions of the Control of Engagements Order, 1947.

THE United Newcastle-upon-Tyne Hospitals.

Royal Victoria Infirmary.

TECHNICAL assistant required in the physics laboratory for X-ray and radium work. The candidate appointed will be required to assist in construction of apparatus and in routine physical problems arising in research. School certificate or higher qualification in science is desired, and candidates should have a keen interest in constructional and electrical problems. Preference given to men completing military service. Salary £220-£325 according to experience.—Applications should be addressed to the House Governor, Royal Victoria Infirmary, Newcastle-upon-Tyne. [3584]

RADIO testers required by Erith manufacturers; experience in production testing.—Apply Box 6096. [3462]

CROWN Agents for the Colonies.—Applications from qualified candidates are invited for the following posts:

TECHNICIANS, Grade I, required by East Africa High Commission for Posts and Telegraphs Department for one tour of 36-48 months in first instance, with prospect of permanency; commencing salary according to age, qualifications and experience in scale £550 to £840 a year; outfit allowance £50, free passages. Candidates, aged 28-35, should possess a thorough practical knowledge of the working and maintenance of modern radio equipment and preferably have undergone a course of works training; experience in the maintenance of modern radio and radar aids to navigation and the possession of City and Guilds certificate in Radio Communications an advantage.—Apply at once by letter stating age, whether married or single, and full particulars of qualifications and experience and mentioning this paper to the Crown Agents for the Colonies, 4, Millbank, London, S.W.1. quoting M/N 23813 (3B) on both letter and envelope.

YOUTH keen on radio, required as junior assistant in radio mail order firm, N.W. London; write.—Box 6177. [3536]

APPLICATIONS are invited for electronic engineers and mechanics for reconditioning v.h.f. wireless equipment, Wellington, Salop, area.—Box 6360. [3583]

NEWSPAPER wire room requires young assistant experienced in electronics and maintenance of 5-unit telegraphic equipment.—Full details to Manager, Westminster Press Provincial Newspapers, 167, Fleet St., E.C.4. [3601]

TECHNICAL correspondence clerk required by radio component manufacturer to handle technical and other correspondence, only fully qualified applicants can be considered; state age, experience and salary required, to Box 6176. [3531]

GOLDRING
Light Weight
PICK-UP
WITH JEWEL POINT
SAPPHIRE NEEDLE

The Latest GOLDRING Pick-up No. 121 has many great advantages, including:—

- Full Frequency Reproduction in combination with a standard Wireless Set.
- Will abolish constant needle changing.
- Will safeguard records through reduced wear.

Write for full descriptive leaflet
ERWIN SCHARF
49-51a, De Beauvoir Road,
London, N.1
Telephone: CLIssold 3434

THIS — Does these —

ACCURATELY and QUICKLY
Chassis, Cracks, Shrouds, Condenser and Transformer clips—**TREPANNING** Steel or Aluminium
Five sizes—12" to 36"
Full particulars from
A. A. TOOLS (W),
197a, WHITEAGRE ROAD,
ASHTON-UNDER-LYNE

BOROUGH POLYTECHNIC

Borough Road, S.E.1.

Full-Time Courses in Radio Engineering

Applications are now being received for admission to a full-time course beginning in September, 1949, in Radio Engineering. The course is designed so that students will spend equal periods at the Polytechnic and in industry over a total period of four years. At the end of the course they will sit the examination for the Higher National Diploma in Radio Engineering.

Students seeking admission should either have passed the School Certificate Examination with credit marks in Mathematics and Physics, or have taken the first and second years of the Ordinary National Certificate Course.

Further particulars and forms on which to apply for admission may be obtained from the Secretary.

CLYDESDALE

For Ex-Services Electronic Bargains.

For those 144 mc/s. experiments. **BRAND NEW. RACK MTG. VHF. R/T RECEIVER UNITS.**

R1481, frequency 65-86 mc/s.
R1132, frequency 100-124 mc/s.
Each a 10-valve (plus stabilizer superhet. Enclosed chassis 19 x 10½ x 11in. Finish (R1481), dark grey; (R1132), light grey. Circuit supplied, all units tested and guaranteed working before despatch. **CLYDESDALE'S PRICE ONLY £4 19s. 6d.** (either). **CARRIAGE PAID.**
Power requirements are: H.T. 210 v. 55 ma, smoothed D.C. L.T. 6.3 v. 3.5 A. provision to just plug in.

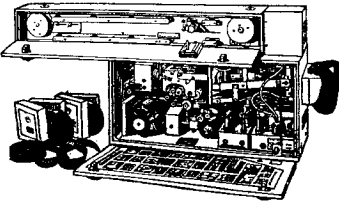

Brand new ex U.S.A. A.F. PANORAMIC GUNNERY TRAINER, Mk. I. Containing a COMPLETE SOUND FILM PROJECTOR with soundhead photo-cell, 150-watt projection lamp, condenser and projection lenses (35 mm. sprockets), 4-VALVE SOUND AMPLIFIER, etc., operating voltage 115 volts, 60 c/s, 405 watts. Would make a sensational novelty as it stands. Used for training gunners for the Service. Supplied in maker's original packing with spares, Service Operating Manual, etc. **CLYDESDALE'S PRICE ONLY £35. CARRIAGE PAID.**

Brand new REFLECTOR AERIAL (MX-137/A RADAR UMBRELLA). A first-class Transmitting and Receiving Omnidirectional Antenna, in original moisture-proof carton with assembly instructions. **5s. 6d. each**

New Ex-R.A.F. BATTERY AMPLIFIER, A1368. A 2-valve 2-stage amplifier, for intercom. and Xntr. mod. pre-amp. Complete (less Batteries), in black metal case 7 x 4½ x 4½in. Improved version of A1134, H.T. 120 v., G.B. 6 v., L.T. 2 v. **11s. 6d. each.**

TRANSMITTER TUNING UNITS. For VFO conversion. TU5B, 1,500-3,000 kc/s., **19s. 6d.** each. Black crackle case 17½ x 7½ x 8in. Unused but scratched and dented.

All goods carriage or post and packing paid. Send now for New Illustrated Lists. Please print.

CLYDESDALE SUPPLY CO., LTD
2, BRIDGE STREET, GLASGOW, C.S.
Phone: SOUTH 2706/9.

Visit our branches in England, Scotland and N. Ireland.

CROWN Agents for the Colonies.—Applications from qualified candidates are invited for the following posts:—
AERADIO mechanics required by Government of Northern Rhodesia for one tour of 24-36 months with possibility of further employment. Commencing salary according to age and experience in the scale £200 to £300 per year. Gratuity payable on satisfactory termination of engagement. Free passage. Candidates, over 25, must have had at least four years' experience in radio engineering, including not less than two years' experience on maintenance and installation of medium power transmitter and v.h.f. ground station equipment. A knowledge of accumulator charging required. Apply at once by letter, stating age, whether married or single, and full particulars of qualifications and experience, and mentioning this paper, to the Crown Agents for the Colonies, 4, Millbank, London, S.W.1, quoting M/N/24675(3B) on both letter and envelope. [3585]

TELEVISION service engineer required for mid-Kent area of supervisory position for man with suitable qualifications.—Give particulars to Box 6071. [3407]

CHIEF draughtsman required with experience in electrical instruments and test equipment design; excellent prospects for man with suitable experience.—Box 5443. [3250]

RADIO-TELEVISION service engineer experienced, starting £7 p.w.—Write or phone Ley, 1362 for appointment to interview.—Frooms Ltd., 226, High Rd., Leyton, E.10. [3383]

SPECIALITY salesmen required for new moving coil meters with permanent needles; samples available—sell on test; most districts vacant; generous commission and expenses.—Box 6090. [3446]

CABLE makers require sales representative with experience in telecommunications and radio; age 25 to 35 years preferred; superannuation scheme and good prospects; full particulars to Box 5438. [3244]

RADIO technician, B.Sc. standard. Requirements: good general education and sound training in fundamentals of radio; some experience; capability for clear technical writing.—Apply Box 6270. [5381]

WANTED, test gear maintenance engineer for large manufacturing concern in radar and radio products; only men with previous experience and knowledge of this branch of industry need apply.—Box 6085. [3434]

THE Ministry of Supply invites applications for a limited number of unestablished posts in the Technical Class Grade II for Electronic and Radio inspection duties in the Aeronautical Inspection Directorate.

APPLICANTS, who must be of British Nationality, born of British parents (see detailed Nationality regulations, a copy of which can be obtained on application to Ministry of Supply, Room 432, Adelphi, John Adam Street, London, W.C.2), should have had sound practical training and experience, have received a technical education up to the standard equivalent to National Certificate (Electrical), have had inspection experience in the particular sphere of manufacture, and have good knowledge of A.I.D. procedure; duties include inspection and the supervision of contractors, inspection of all items handled in the Radio and Radar branch, both during and after manufacture. Applicants must be prepared to serve in any part of the United Kingdom. Salary ranges: £500 (linked to entry at age 30) to £625 (London); £485 (linked to entry at age 30) to £510 (intermediate); £470 (linked to entry at age 30) to £495 (Provincial). Hours of work, 4½ nett weekly. Applications should be made by letter only, giving full details of age, education and experience, and the names and addresses of present and all previous employers in chronological order, with particulars of the posts held. These should be addressed to London Appointments Office, Ministry of Labour and National Service, 1-6, Tavistock Sq., London, W.C.1, quoting the reference K.I.272. Copies only of testimonials should be forwarded with applications. [3599]

VALVE manufacturing company in S.E. England require a design engineer with experience of mercury vapor rectifier valves.—Graduates aged 25-35 should apply, quoting Ref. No. C.6/234, to Box 6361. [3593]

TELEVISION engineer required for factory production, area South of London.—Write, stating age, experience and salary required, to Box No. 126, S. T. Garland Advertising Service, Ltd., 52, Mount St., London, W.1. [3425]

SENIOR draughtsmen required, must have experience in detailing radio or electronic equipment; North London district.—Write, stating experience and salary, to Box U1522, A.K. Advg., 212a, Shaftesbury Ave., W.C.2.

FOREMAN to take charge of transformer division of West Country manufacturers. Experience of coil winding and assembly of transformers up to 50kVA essential, and some previous executive experience desirable. Give details of experience, with dates, to Box 5435.

INTERMEDIATE and senior grade draughtsmen required by large radio manufacturing company in S.E. England; draughtsmen with experience of development or installation D.O. work on telecommunication equipment are asked to send details quoting ref. D.O.42 to—Box 4766. [3074]

R1224A. 5-VALVE BATTERY SUPERHET. A superb ex-R.A.F. receiver covering 1-10 mcs. in 3 switched bands. Circuit employs R.F. stage. Has Muirhead precision slow motion dial, aerial trimmer, sensitivity control, reaction control, etc., etc. Operating voltages 120 v. H.T., 9 v. G.B. 2 v. L.T. Complete with valves, and **BRAND NEW IN ORIGINAL MAKERS' PACKING, ONLY 99/6** (carriage 7/6).

R 3084 RECEIVER. An ideal unit for conversion to a vision receiver, and to assist intending constructors we supply with each unit full details showing how this can be done. Contains valves as follows: 2 EF54, 1 EC52, 7 EF50, 1 YU39A, 1 HVR2, 1 EA50, and 30 mcs. IF strip. **BRAND NEW IN MAKERS' PACKING, ONLY 75/-** (carr. 10/-).

INDICATOR UNIT 62A. The cheapest way of buying EF50s and a YCR 97 tube. Besides the tube it contains 12 EF50s, 2 EB34s, 4 SP61s, and 3 EA50s, in addition, of course, to shoals of condensers, resistors, etc. Ideal for a TV constructor. **ONLY 89/6** (carr. 10/-, plus 10/- deposit on transit case).

ADMIRALTY TRANSMITTER 7AD, PATTERN W4832. First come, first served, with this "snip." Contains valves types 6V6G, VU 111 CV73, and 2 CV63, transformers, small components, transmitting gear, etc. etc. **BRAND NEW, ONLY 19/6** (carriage 5/-).

INSULATION TESTERS (MEGGERs). Ex-R.A.F. testers by "Record," reading up to 20 megohms at 500 v. pressure. **BRAND NEW.** Listed at over £12. Our price is **ONLY £8/10/-** postage paid.

IF YOU ARE INTERESTED IN BUILDING A TV you should send for a copy of the data showing how you can build a complete sound and vision receiver from EX-GOVT. RADAR GEAR. This consists of 26 large pages of circuits, instructions, and actual photographs of the units specified, and costs 7/6. The two radar units cost £6/10/-, the data being supplied gratis, but to intending constructors who wish to read through the data first we will credit the cost if the two units are purchased within 14 days.

The power supplies are derived from a combined H.T. and E.H.T. transformer costing £5/10/-, but if this is purchased with the radar units the total cost is £11/10/-, showing a saving of 10/-. Other small components not in the radar units are conveniently listed to enable constructors to see what they have available from their own stocks, but we can supply everything. As a guide, the cost of these additional components is £6/7/4, including speaker and control knobs, therefore bringing the total cost to under £18. When ordering by post please add 12/6 carriage, plus 10/- deposit on packing case.

C.W.O., PLEASE. S.A.E. for lists.

U.E.I. CORP., THE RADIO CORNER,
138, Gray's Inn Road, London, W.C.1.
TERminus 7937

Open until 1 p.m. Saturdays, we are two mins. from High Holborn, five mins. from Kings Cross.

TELEVISION

The advance in Radio Technique offers unlimited opportunities of high pay and secure posts for those Radio Engineers who have had the foresight to become technically qualified. How you can do this quickly and easily in your spare time is fully explained in our unique handbook "Engineering Opportunities."

Full details are given of A.M.I.E.E., A.M.Brit.I.R.E., City & Guilds Exams., and particulars of up-to-date courses in Wireless Engineering, Radio Servicing, Short Waves, Television, Mathematics, etc., etc.

We Guarantee "NO PASS—NO FEE"

Prepare for to-morrow's opportunities and future competition by sending for your copy of this very informative 112-page guide NOW—FREE.

BRITISH INSTITUTE OF ENGINEERING TECHNOLOGY
(Dept. 388) 17, Stratford Place, London, W.1

The "ADCOLA" Soldering Instrument

Reg. Trade Mark.



Designed for Wireless Assembly and Maintenance.

Working temperature reached in 1½ mins., consumption 25 watts, weight 2½ ozs. Supplied in voltage ranges from 6/7v. to 230/250v. ⅜" diam. Copper Bit (standard model) 22/6. 1/4" diam. Copper Bit 25/-.

Replacement Unit Bit Elements available. British and Foreign patents.

Sole Manufacturers:
ADCOLA PRODUCTS LIMITED
Alliance House, Caxton Street, London S.W.1
Write or Phone: WHI. 0030.

THE BRITISH NATIONAL RADIO SCHOOL

ESTD. 1940

Passing Examinations
Becomes a
MATTER of COURSE
when it's
A B.N.R.S. COURSE

City and Guilds, A.M.I.E.E.,
A.M.Brit.I.R.E., P.M.G. (Theory),
also the most comprehensive
Course available anywhere on
RADAR & Radio Aids to
NAVIGATION

Six months' trial period without
obligation to continue

Write for free booklet to:—

STUDIES DIRECTOR
BRITISH NATIONAL RADIO SCHOOL
66, ADDISCOMBE ROAD, CROYDON
Phone: Addiscombe 3341

**“Radiospares”
Quality Parts**

**THE
SERVICE ENGINEER'S
FIRST CHOICE**

ENGINEERS!

Whatever your age or experience, you must read “ENGINEERING OPPORTUNITIES”. Full details of the easiest way to pass A.M.I.Mech.E., A.M.I.E.E., A.M.I.C.E., CITY & GUILDS, MATRIC, etc. on **108 PAGES Free!** “NO PASS—NO FEE” terms and details of Courses in all branches of Engineering—Mechanical, Electrical, Civil, Auto., Aero., Radio, etc., Building, etc. If you're earning less than £10 a week, tell us what interests you and write for your copy of “ENGINEERING OPPORTUNITIES” today—FREE!

B.I.E.T.

897, Shakespeare Hse.,
17-19, Stratford Place,
London, W.1.

BRITISH INSTITUTE OF ENGINEERING TECHNOLOGY

REQUIRED by a firm engaged in the development and design of telecommunications equipment near Maidenhead.

(1) ENGINEERS having degrees in physics or engineering science with practical experience in the development and design of v.h.f. or u.h.f. single-channel or multi-channel radio telephony equipment.

(2) ASSISTANTS with practical experience in assisting in the design of such equipment and the assembling of parts. Salary scale with annual increments and pension fund.—Apply in writing Box No. 406, Dorland Advertising, Ltd., 16-20, Regent St., W.1. [3588]

ENGINEERING representative for leading London automobile radio equipment producers; only applicants with sound technical training and experience in comparable field need apply; excellent prospects; salary according to experience.—Box 6066. [3599]

INDUSTRIAL electronic engineers required, Manchester area, for technical representation installation and service work, higher National Certificate standard.—Reply, stating age, qualifications, experience, salary required.—Box 6226. [3550]

ALL grades of draughtsmen with experience of high electrical products required by large company in N.W. England for D.O. work on switchgear, control boards, fusegear, small transformers; please send particulars, quoting ref. D.O.43 to Box 4767. [3075]

RADAR service engineers required by London firm specialising in marine radar; applicants should be ex-Army Staff Sergeants or Navy P.O. grades, with experience service radar and passed long radar course; good pay, prospects and travel.—Write Box 6076. [3417]

DEVELOPMENT engineer required for development of electronic control and recording equipment, must possess honours degree in physics or engineering and have practical experience according to qualifications.—Brown Brothers & Co., Ltd., Rosebank Ironworks, Edinburgh, 7. [3318]

ELECTRONIC engineer required by progressive company, Central London, for circuitry development work; must have had previous experience in commerce and be up to C. and G. radio pass standard; applicants over 35 need not apply; salary according to experience.—Write Box 6093. [3452]

SALES engineer, must possess qualifications S and experience of R.F. cables and ability to act as technical representative, active man used to own initiative; part time also considered.—Write fullest details and salary to: C/O Dixons, 43, Great Marlborough St, London, W.1. [3057]

RADIO service engineer, age 25-35 preferred, fully qualified, smart appearance and accustomed to carrying out installation in the home; full knowledge of all H.M.V. and Marconiphone Instruments essential.—Apply, stating experience and salary required, to Manager, “His Master's Voice,” 353, Oxford St., W.1. [3442]

SENIOR design draughtsman for mechanical design of television receivers, must have had three years' experience in similar capacity radio or television; salary £450-£550; minimum age 25. WRITE: Personnel Manager Sobell Industries, Ltd., Langley Park, Langley, Bucks, stating qualifications and experience. [3414]

CHIEF engineer wanted for company manufacturing electrical measuring instruments and industrial radio and electronic test equipment; excellent position and prospects for man with suitable experience; write giving full particulars of experience and qualifications and salary required to Box 5444. [3251]

TESTERS required for radio and radar equipment, must have had previous experience of production test and alignment; technical qualifications to C and G standard; North London area.—Write, stating experience and salary required to Box U.1555, A. K. Adv., 212a, Shaftesbury Ave., London, W.C.2. [3500]

JUNIOR electronic engineers required; must have sound technical background and show initiative, in particular, in reasoning from effect to cause; any knowledge of pulse and U.H.F. techniques an advantage.—Apply in writing to J. Langham Thompson & Co., Springland Laboratories, Stanmore Hill, Middlesex. [3449]

DRAUGHTSMEN, senior and junior, required in development drawing office for new and expanding project by large manufacturer in East London area; applicants should have had thorough drawing office training in electronics or light electrical engineering.—Please state full details, including salary required, to Box 6064.

POSITIONS available for experienced senior and junior development and research engineers (preference B.Sc. H.N.C.), also experienced draughtsmen for radio, radar, electronics, speakers, etc.; inspectors, testers, repairers, service engineers required.—Technical Employment Agency, 179, Clapham Rd., S.W.9. (Brixton 3487.) [3529]

A. H. HUNT, Ltd., have vacancies for laboratory engineers for work on design and manufacture of capacitors; duties will require a basic knowledge of power and radio frequency engineering with a general understanding of applied physics and chemistry. Previous work on capacitors not essential.—Write or call, A. H. Hunt, Ltd., Bendon Valley, Garratt Lane, Wandsworth, London, S.W.18. [3596]

AMC

TELEVISION

Manufactured to “Electronic Engineering” Televisor Specification.

NEW Improved
LINE OUTPUT TRANSFORMERS

NEW Improved
SET OF GANTRIES COMPLETE

NEW Improved FOCUS COILS

All Steel CADMIUM PLATED
POWER AND TIME BASE
CHASSIS valve-holders, 3 point
and single socket and all necessary cut-outs.

SOUND PANEL CHASSIS
ASSEMBLY, fitted with screens,
valve-holders, formers and dust cores.

VISION PANEL CHASSIS
ASSEMBLY, fitted with screens,
valve-holders, formers and dust cores.

9" C.R. TUBE SUPPORT for
mounting on top of Gantry Assembly.

9" CREAM MASKS.

5, SHAKESPEARE RD., FINCHLEY, N.3
Phone: FINchley 2188

YOUR METER DAMAGED ?

don't scrap it -
LET GLASER REPAIR IT!

Leading
Electrical
Instrument
Repairers
to the
Industry.

Repairs by skilled craftsmen to all makes and types of Voltmeters, Ammeters, Microammeters, Multirange Test meters, Electrical Thermometers, Recording Instruments, Synchronous Clocks, etc. 14 days' Service—for speedy estimate send defective instrument by registered post to:

L. GLASER
SCIENTIFIC & ELECTRICAL INSTRUMENT REPAIRERS
341 CITY ROAD, E.C.1.
Tel. Terminus 2489

POST RADIO SUPPLIES

OFFER EX STOCK

COPPER INSTRUMENT WIRE.
ENAMELLED, TINNED, LITZ.
COTTON AND SILK COVERED.

Most gauges available.
B.A. SCREWS, NUTS, WASHERS,
soldering tags, eyelets and rivets,
EBONITE AND BAKELITE PANELS,
TUFNOL ROD, PAXOLIN TYPE COIL
FORMERS AND TUBES, ALL DIAMETERS.

Latest Radio Publications.

Send stamped addressed envelope for comprehensive lists. Trade supplied.

POST RADIO SUPPLIES

33, Bourne Gardens, London E.4.
Phone: CLIssold 4688

LASKY'S RADIO
CUNNINGHAM 1979
MEMBER R.F.A.
World Renowned for Service & Reliability

INDICATOR UNIT TYPE 62. Contains 20 valves and a 6in. cathode ray tube type VCR97 (short persistence.) Valve line up: 16 SP61; 2 EA50; 2 EB34; dozens of other components, resistances, condensers, coils, crystal, 16 pot/meters, etc. Totally enclosed in metal cabinet, size 18in. x 8in. x 11in. Weight, 40 lbs. Enamelled black with coloured control knobs.
LASKY'S PRICE 59/6 Carriage 7/6 extra.

SPECIAL MAY OFFER, NEW PURCHASE:
16 VALVE AMERICAN RADAR RECEIVERS. 4 Switch selected R.F. channels, 16.5 Mc/s. I.F. frequency 1050 Kc/s, band width 60-45 Kc/s. Valve line up: 2 2X2; 3 6B4; 4 6SK7; 1 each of 5U4; 6S47; VR150; 6S37; 6H6; 6SN7; 6SL7. Contains power supply for a 6in. cathode ray tube with 400 c.p.s., transformer. Also a host of useful components. Totally enclosed in metal cabinet, black crackle finish, size 19in. x 8in. x 7in. Weight, 30 lbs. DO NOT DELAY. ORDER AT ONCE TO AVOID DISAPPOINTMENT.
LASKY'S PRICE 59/6 Carriage 5/- extra.

BRAND NEW AND UNUSED EX-GOVERNMENT CATHODE RAY TUBES. TYPE VCR97, 6in. SHORT PERSISTENCE. Each tube is fully guaranteed and is tested before despatch. Contained in specially sprung wooden transit case. CHARACTERISTICS: heater 4 volts, 1 amp., H.T. 2,500 volts maximum.
LASKY'S PRICE 35/- Carriage 7/6 extra.

E.H.T. TRANSFORMERS, for the VCR97 Cathode Ray Tube and L355 Receiver. SPECIFICATIONS: Primary 200/250 volts 5.0 c.p.s. Secondary 2,500 volts at 4 ma., 4 volts at 1.1 amps, and 4 volts (centre tapped) at 1.5 amps.
LASKY'S PRICE 35/- Post 1/6 extra.

RADAR RECEIVER TYPE 3084A. BRAND NEW AND UNUSED IN MAKER'S WOOD TRANSIT CASE. Specifications: 14 brand new valves, 7 EF50; 2 VR136; 1 VR137; 1 EA50; 1 HV2E; 1 B3; 1 V1507. Dozens of useful components, including 80 volt A.C. motor used for aerial switching, front panel tuning control, etc. With little modification this will make an ideal 2 meter receiver. Also suitable for television conversion. Totally enclosed in metal case, size 19in. x 8in. x 7in. Weight when packed 40 lbs. We will exchange the 2 VR136's for EF50's (if so required).
LASKY'S PRICE 75/- Carriage 5/- extra, in wood case (case incl.).

Send 2/6 stamp with your name and address (in block letters please) for a copy of our current monthly list of Ex-Government bargains, the Lasky's Radio Bulletin, by return.

LASKY'S RADIO
370 HARROW RD., PADDINGTON, LONDON W.9. (Opp. Paddington Hospital)
Telephone: CUNNINGHAM 1979.
Hours: Mon.-Sat. 9.30 a.m. to 6 p.m. Thurs. Half-day

MILLETT & HOLDEN LTD.
BIRCHAM RD., SOUTHBEND-ON-SEA, ESSEX

TRANSFORMERS
FOR ALL PURPOSES

COINCIDING WITH THE OPENING OF OUR NEW FACTORY WE ARE PLEASED TO PRESENT OUR NEW RANGE INCLUDING HIGH-VOLTAGE VIBRATOR, NEON LIGHTING, ELECTRONIC & INDUSTRIAL TYPES. IN ADDITION WE ARE PLEASED TO QUOTE FOR YOUR OWN REQUIREMENTS. EVERY 'M & H' TRANSFORMER IS MANUFACTURED BY MOST MODERN METHODS, FULLY VACUUM-IMPREGNATED & GUARANTEED.

IF YOU ARE INTERESTED IN TRANSFORMERS, WHY NOT LET US HELP YOU?

ELECTRONIC engineers preferably with factory experience are required by works situated on the Treforest Trading Estate near Cardiff. Knowledge of the basic principles of design essential. Salary £350-£500. Full details of training and experience to Box 6065. [5336]

LABORATORY assistant, with experience or interest in electrical instruments or radio, required for electronic work; Inter. or National Certificate standard expected.—Apply to Secretary, British Rayon Research Association, Bridgewater House, Whitworth St., Manchester.

A and physics graduates by the Research Laboratories of The General Electric Co. Ltd., East Lane, North Wembley, Middx., for work on telecommunications equipment and radio navigation aids; details of age, academic record and experience should be sent to the Personnel Officer. [3515]

ASSISTANT to service manager of radio manufacturing firm required in London, technical radio experience in Forces or with radio manufacturers or large group retailers' organisation, and ability to deal with correspondence essential; suitable to ex-Service radio officer of secondary school educational standard.—Box 6070. [3406]

WIREMEN for radio and electronic apparatus required to wire from circuit diagrams and models, various intricate units of television transmission apparatus; ability to carry out modifications or to build new types from verbal instructions or diagrams only, and to carry out stage by stage test and inspection would be an advantage.

VACANCIES also exist for special assemblers to assemble from diagrams and models, components and sub-assemblies and also to construct units ready for wiring; persons able to assist on wiring will be given special consideration.—Applications should be made to Box 6038. [3444]

DRAUGHTSMEN are required by the Research Laboratories of the General Electric Co., Ltd., North Wembley, Middlesex, for work in the field of radio or telecommunications; vacancies exist for seniors with several years' experience as well as for more junior candidates.—Apply to the Director, stating age, academic qualifications and experience. [3005]

REQUIRED, technical cost engineer, must have full experience of development and production D.O.s, tool design and production planning; experienced in the complete estimating for factory managed in the electrical and radio industry.—Write in confidence, giving full particulars of experience, qualifications and salary required, to Box 6073. [3410]

ELECTRONICS laboratory assistant required. Reading-Newbury area, for work on design and construction of all types of electronic equipment; practical experience essential.—Apply in writing, giving full particulars, to Manager, Associated Electrical Industries Research Laboratory, Aldermaston Court, Aldermaston Berks. [3468]

ENGLISH ELECTRIC Co., Ltd., Stafford, require urgently electronic draughtsmen of all grades for research, development and production drawing offices; experience in this field essential; good conditions and prospects.—Please quote Ref. D.O.53 when sending full details to Central Personnel Services, English Electric Co., Ltd., 24-30, Gillingham St., London, S.W.1.

An interesting vacancy exists for honours degree physicist or electrical engineer to take charge of instrumentation development work on industrial electronic equipment in Midlands; preferably 28-35 years old with previous experience and a capacity for leading a development team.—Please quote Ref. 232 and send full details and salary required to Box 6105.

SOUTH Coast firm require laboratory assistant for experimental work concerning high-frequency characteristics of capacitors and inductors relative to interference suppression; capable of working on own initiative, knowledge of general electrical engineering theory and practice desirable.—Write, stating age, experience and acceptable salary required, to Box 6175. [3530]

THE FAIREY AVIATION Co. Ltd., Hayes, Middx. requires engineers with experience of electro mechanical servo mechanism control circuits or auto-pilot design for research divisions U.K. and Australia; applicants should be capable of undertaking research and development work on the above; university degree or equivalent an advantage.—Apply to Personnel Manager. [3589]

RADIO engineer designer with experience of research and development laboratories, design and production drawing office and model-making departments; must have initiative and ideas to take complete control of design and development departments of radio and light engineering factory, location London area.—Write in confidence, giving full particulars of experience, qualifications and salary required, to Box 6074. [3411]

LARGE electrical engineering firm in South London with international connections, has vacancy for responsible senior design engineer; applicants must have first-class experience in developing 50 cycle and A.F. electronic equipment to production stage and a feeling for light mechanical designs; University degree preferred; very interesting permanent appointment; state age and salary required.—Box WW80, L.P.E., 110, St. Martin's Lane W.C.2. [3426]

D ENCO RADIO
High Class Radio Manufacturers

★ Use DENCO "MAXI Q" COILS High "Q" with miniature size.
There is one for all wavebands from 3.6 to 2,000 metres.
Wound with Litz on Polystyrene. Formers with adjustable Iron Dust Cores—Aerial, H.F., or Oscillator types available, 465 K/C or 1.6 m/c.
Prices—Chassis Mfg. 3/9 (with React. 4/9), or Pin Base type, fits Octal Valve Holder, 4/- (with React. 5/-).

HOME CONSTRUCTORS TELEVISION KIT

- ★ A new complete Kit of Parts for the building of a high definition, vision and sound Television Receiver, using a 9in. CRT and with power supply for 200-250 volt AC mains.
- ★ Employs recently developed circuits and components including line fly-back EHT/output transformer unit, ready assembled. Vision section has 3 RF stages, Detector, Noise Limiter, and Video Amplifier.
- ★ Suitable for use at all distances within the service area of the station.
- ★ The new miniature high slope BTG pentode valves are used in RF and video stages, etc., a total of 17 valves.
- ★ Circuit, layout and instructional data supplied with each Kit.
- ★ All valves and CRT, chassis, etc., are included (Loudspeaker and O.P. Transformer excluded). Price complete, £36 (P. Tax £3/11/-).
- ★ A similar Kit to the above incorporating a 12in. C.R.T. will be available late June at an additional cost of approx. £4/6/-.
- The following units will be available for sale separately, each complete with Circuits, Layout and Instructional Data.

- ★ DTK3/RF. Outfit consisting of all components, valves and 9in. C.R.T., for vision and sound sections up to the detector stages, including drilled sub-chassis. Price £14/15/- (Tax on Valves, etc., £3/16/7).
- ★ DTK3/TB. A similar outfit for time base circuits including ready assembled fly-back EHT, video amp., sync. separator, deflector and focus assemblies and main chassis. Price £15/5/- (Tax on Valves, 19/9).
- ★ DTK3/PS. Complete Power supply outfit (excluding EHT which is part of line output circuit) consisting of all components and rectifier valve: output 310 v., 225 M.A. and 6.3 v. 7 a. (rect. heater winding also). Price £6/7/6 (Tax on Valve, 3/3).

Mains INTERFERENCE FILTER, 4/6. Other available Denco Products are listed in a most comprehensive and detailed Catalogue. Price 9d.

EXPORT AND TRADE ENQUIRIES INVITED.
DENCO DISTRIBUTORS LTD.,
115, FLEET STREET, E.C.4.
Tele: CENTRAL 5814 and 2280.

RADIO UNLIMITED

"Return of Post" Mail Order Service.
16, CARNARVON ROAD,
LEYTON, LONDON, E.10.

- Announce the following new lines:—
- Radiogram Chassis.** A.C. mains, 3 waveband, 5 valve superhet. Large attractive dial, Volume, Tone, Gram switching, etc. Complete with 8in. P.M. speaker. 12 gns. inc. tax.
 - Amplifier Chassis.** A.C. mains, 3 stage amplifier, for Mic., Gram and Radio. Complete with 8in. speaker, 6 gns. Local station Tuner, 17/6 extra.
 - A SOUND PROPOSITION.** "Vortexion" 12 v. D.C./230 v. A.C., Mobile 15 watt amplifier, £28. Descriptive literature on request.
- June catalogue now ready. 1d. stamp please.

L-R-S FOR
**PROMPT & EFFICIENT
SERVICE**

CASH or EASY TERMS

ARMSTRONG All-Wave CHASSIS
Various Models available.

Goodman's "Axiom Twelve" Speaker Unit
Cash price £8 8 0

Goodman's Standard 12" Speaker " £6 15 0

Avo Meter Model 7 " £19 10 0

Avominor AC/DC Meter " £8 10 0

Avominor DC Testmeter " £4 4 0

Avo Valve Tester, Complete " £16 10 0

Gollaro Radiogram Units—various models.

**GOODSELL-WILLIAMSON High Fidelity
AMPLIFIERS**

Specifications of all the above on request.
Please write for our **EASY TERMS.**
PERSONAL ATTENTION TO ALL ENQUIRIES

The LONDON RADIO SUPPLY CO.
Est. 1925
BALCOMBE, SUSSEX

RELAYS
for A.C. and D.C.

2 VA Coil consumption
from 2 to 60V
volts and tested to
2000 volts, Aerial
Changeover Relays,
Mercury Relays,
Measuring Relays and
Time Delay Relays



Midget Relay ML/C Ask for leaflets
REJWW

LONDEX LTD
Manufacturers of Relays
207 ANERLEY ROAD, LONDON, S.E.20
SYDenham 6258

RANSOM
FOR RADIO VALVES

Just a selection from our Clearance Price List issued each month. List available.

SPEAKERS. P.M. 5in., 9/6; 6in., 10/6; 8in., 14/6; 8in. with transformer, 17/-.

CONDENSERS. Cardboardpak 1 mfd. 350 v., 1/-; 2 mfd. 150 v., 6d.; 2 mfd. 350 v., 2/-; 20-20 mfd. 25 v., 1/6; 25 mfd. 50 v., 1/8; 60 mfd. 12 v., 6d.; 50 mfd. 50 v., 2/4. Aluminium Cans Standard Pak. 8 mfd. 450 v., 2/6; 8-9 mfd. 450 v., 3/4. Aluminium Cans Midgetpak. 4 mfd. 450 v., 2/6; 16 mfd. 450 v., 2/3; 16-8 mfd. 450 v., 4/3; 8-8 mfd. 450 v., 3/9; 32 mfd. 350 v., 4/11. Miscellaneous. 1 mfd. 800 v., 7d.; .02 mfd. 750 v., 5d.; .02 mfd. 400 v., 3d.; .01 mfd. 1,000 v., 4d.; .001 mfd. 1,000 v., 4d.

YAKLEY TYPE SWITCHES. 2 way 4 pole, 2/4; 2 way 6 pole, 2/6; 3 way 3 pole 2 bank, 2/-; 3 way 3 pole 3 bank, 3/-; 4 way 3 pole, 3/-.

GARRARD AUTO-CHANGER A.C. TYPE R095, p.l.y.s 10in. and 12in. mixed records. £15/11/5.

EAR PHONES. 2,000 ohms, 7/9.

MIDGET RADIO CABINETS. 15/- each.

ENAMELED WIRE. 4 oz. coils, 24 swg., 1/10; 26 swg., 2/-; 28 and 30 swg., 2/1; 32 and 34 swg., 2/6.

VALVES. Most types available 10,000 stocked. All new, at official B.O.T. prices. Valve list available.

34, BOND STREET, BRIGHTON.

SANGAMO WESTON, Ltd., have two vacancies in their instrument sales correspondence section; applicants should have had a good general technical training, with some specialisation in electrical measuring apparatus; they should be capable of expressing themselves clearly and concisely both in conversation and correspondence.—Applications should be sent in strict confidence to the Employment Manager, Sangamo Weston Ltd., Great Cambridge Rd., Enfield, Middx. [3054]

DESIGNER draughtsman required by Airmec Laboratories, Ltd., Cressex, High Wycombe, for work in the field of radio and telecommunication equipment; applicants should have served a recognised apprenticeship in light engineering or have equivalent shop training, also academic qualifications to the Senior National Certificate standard in electrical engineering or mechanical engineering.—Applications should be made in writing, stating age, academic qualifications, experience and salary required, to the Personnel Manager. [3598]

LARGE company operating in West Africa require first-class practical engineer, aged not over 30 years, to take full responsibility for servicing motor, radio, refrigerator, Diesel injection equipment, and allied lines throughout their territory; good commencing salary, furnished quarters and medical attention provided at company's expense, first-class passage paid out and back, with adequate leave arrangements; this position offers excellent prospects to right man willing to make his career in West Africa.—Applications to Service Manager, Murphy Radio, Ltd., Welwyn Garden City, Herts. [3461]

BRITISH company, operating in Brazil, requires a coil plant superintendent for an extensive toll network of voice and carrier frequency telephone circuits serving large and small towns in an area of 200,000 square miles; candidates should be about 35 years of age, should have an engineering degree or equivalent, and wide telephone experience, the engagement provides for three years of service with four months of leave, and will be permanent for a man of satisfactory ability; the position is of an executive character with good salary.—Suitable candidates only should write, giving personal particulars and references, to the Personnel Office, to Box W.W.321, at 191, Gresham House, E.C.2. [3565]

A VAGANCY occurs with progressive South Coast firm for practically minded technician capable of carrying out tests in connection with radio interference suppression and in designing and developing suppression equipment and apparatus; applicants should be capable of attending to correspondence and other administrative matters arising from this work; experience in the design and manufacture of electrical equipment for the Admiralty will be an added qualification; the post necessitates a theoretical knowledge of both electrical and radio in addition to practical ability and experience.—Applications should state age, technical qualifications, practical experience and acceptable salary and be addressed to Box 6067. [3402]

B.C.C. invites applications for an engineering department based initially at Ealham, S.W.12, and probably after about one year at Kingswood, Surrey; applicants must possess a University degree or equivalent qualifications in electrical engineering; experience in the design of light electrical and mechanical equipment and the ability to guide development work in the drawing office and workshops is essential; a knowledge of music will be an advantage; the successful applicant will be employed on research and development work in all aspects of sound recording and familiarity with low frequency electronic technique is essential; ample scope will be afforded for initiative; the salary is in a grade with annual increments of £30 and a maximum of £650 per annum.—Applications stating age, qualifications, details of past and present employment, should reach the Engineering Establishment Officer, Broadcasting House, London, W.1. within seven days of the appearance of this advertisement. Please quote RD(R).

B.C.C. invites applications for an engineering post in the audio frequency section of research department based initially at Ealham, S.W.12, and probably after twelve months, at Kingswood, Surrey; candidates must possess a University degree or equivalent qualifications in electrical engineering or physics and must have studied telecommunications as part of their curriculum; a knowledge of electrical measurements, measuring instruments and experience in microphone and loudspeaker technique is essential, while musical ability will be of great advantage; preference will be given to a candidate with the ability to guide development work in the drawing office and workshops; the successful candidate will be required to take part in research on microphones and loudspeakers and all other aspects of audio frequency research and development; the salary is in a grade with annual increments of £40 and a maximum salary of £890 per annum.—Applications, stating age, qualifications, details of past and present employment, should reach the Engineering Establishment Officer, Broadcasting House, London, W.1. within seven days of the appearance of this advertisement. [3454]

NEW 2-GANG TUNING CONDENSERS, 470 pF (nominal .0005 uF.) by famous British maker. NOT ex-Govt. Ceramic insulation. Frame size 2 1/2in. high, 1 1/2in. wide, 2 1/2in. deep. Spindle 1/2in. diam., 1in. long. Normally 13/3, available NOW at 5/- each, inc. postage.

3-GANG TUNING CONDENSERS, 470 pF., famous make. Ceramic insulation. Frame 2 1/2in. high, 1 1/2in. wide, 3 1/2in. deep. Standard 1/2in. diam. shaft, 2 1/2in. long. 6/3, inc. postage.

NEW PAPER FILTER CONDENSERS, 8 uF. 600 volts D.C. working at 71° C. (stand higher in normal temperature). Famous British make, individually tested and leak-free. 4 1/2in. high (plus terminals 1/2in.), 4 1/2in. wide, 2in. deep (plus fixing lugs 1/2in. each side). Original carton of TWO for 11/6, inc. postage.

Despatched immediately on receipt of order and remittance, but hurry!

WIRELESS SUPPLIES UNLIMITED,
264-266, Old Christchurch Road,
BOURNEMOUTH, Hants.

**ELECTRONICS
DUPEY
LTD.**
CRANMER AV. EALING, W 13.

Transformer and Coil Manufacturers to the Trade
Telephone: EALING 5688

**THE Q5R9 HIGH PERFORMANCE AERIAL
FOR BETTER TELEVISION.**

Folded dipole, multielement design; executed in high duty alloy, provides wide bandwidth, high gain, low noise, and results in higher definition and longer range.

- ★ FD2. 2 Element 5 db gain, 7 1/2 lbs. weight.
- ★ FD3R. Triple reflector, for low interference.
- ★ FD3E. 3 Element long range, 7 1/2 db gain.

Also available for **BIRMINGHAM** frequency.
EMDO LIMITED, ACE WORKS, STAINES.

CRYSTALS
FOR
**AIRCRAFT
MARINE
AND
AMATEUR
TRANSMITTERS**
ALL LOW TEMP. CO-EFF. CUTS.
BROOKES CRYSTALS LTD.
10, STOCKWELL ST., GREENWICH
GRE. 1828 LONDON S.E.10.

OLDCHURCH LABORATORIES

Announce
The "LABCHURCH" A.C. Superhet Design.
Three Circuit and Layout Blueprints with Instruction
Leaflet covering 3-waveband "short" superhet chassis
design, incorporating Iron-cored Coils. This is a sound
and practical design of good performance without
unnecessary "frills." Complete Data 7/6d. Post free.

**TELEVISION AND OSCILLOSCOPE
EXPERIMENTERS**

E.H.T. Transformers 37/6 plus 1/6 post.
2,000v. at 3 m.a. 4v. C.T.—2a. 4v. C.T.—2a.
A First-class component which has passed the most
stringent tests. 2,000v. at 11 m.a. 4v. at 2a. C.T.
30/-, plus 1/6 post.

1155 Receiver
A few in good condition, Aerial tested 28/10/-,
plus carriage.

Just Arrived
The one and only "Muirhead" Drive, Ex-Govt. New
and Boxed, 10/6 each.

L. P. DISMORE,
52, Oldchurch Road, Chingford, E.4.

MIDLAND INSTRUMENT Co.
FOR GOVT. SURPLUS STOCK, ETC.

E.P.L. INSULATION TEST SETS, 5,000 v. A.C. or D.C., consists of three transformers, H.T. rectifier, magic eye leakage indicator, 3in. scale m.c. 0-5,000 v. meter, instrument rectifier, variable voltage control resistance, H.T. mains and test switches, fuses, etc. in metal case 14in. x 10in. x 10in., with test leads but less prds.—operates from 200/250 v. A.C. mains, used, otherwise in perfect condition, bargain, £7/10/-, plus 10/- carriage.

U.S. ARMY FREQUENCY METERS TS-69/AP, covers 341 to 1,000 mc/s with high precision cavity, suitable for amateur band 490/466 mc/s., 341 to 700 mc/s., limits of mc/s., 700 to 1,000 limits of 2 mc/s., indicated on vee-der counter, 4 1/2in. x 4in. square panel mtr. 0 to 200 microampere meter with 3 1/2in. scale, stub aerial, crystal valve, etc., etc. in smart crackle finish metal case, 2 1/2in. x 5in. x 5in., calibration sheets in hinged frame, also transit case, brand new unused, 70/-, carriage 10/-.

BURGLAR ALARMS, closed circuit type, embodies 200-ohm drain relay, with holding (non-return contacts), also 4-ohm setting winding and heavy alarm circuit contacts, press button setting switch, closed circuit test lamp indicator, unset to set changeover switch, in very smart and attractive grey finish metal wall fixing cases, 7in. x 4 1/2in. x 3in., with side fitting plugs for closed circuit and battery connections, operates from 6 to 12 v. battery, also 6 to 12 v. alarm bell (not supplied), superior to those now selling at £5 and over, brand new, 30/-, post 1/-, with all instructions.

BURGESS MICRO SWITCHES, ideal for using with above burglar alarms, 1/6, post 3d., four different types, 5/-, post 9d.

EVERSHED & VIGNOLES insulation and continuity test "MEGGERS," 100 v. pressure, twin scale, zero to 10 meg. and inf. insulation and 0 to 100 ohms continuity, in the standard grey aluminium case, condition as new, £7/10/-, post 1/4.

Our new June/July lists available shortly, hundreds of new items, send S.A.E. for a copy when available.

MOORPOOL CIRCLE, BIRMINGHAM, 17
Tel. HARborne 1308 or 2664

THESE ARE IN STOCK

- The Radio Amateur's Handbook.** By A. R. R. L. 1949. 15s. 6d. Postage 1s.
 - Radio Valve Data.** Compiled by the Wireless World. 3s. 6d. Postage 3d.
 - Vade Mecum 1948 Edition, 2 vols.** By P. H. Brans. 19s. Postage 9d.
 - Microwaves and Radar Electronics.** By E. C. Pollard & J. M. Sturtevant. 30s. Postage 9d.
 - Electronics Circuits and Tubes.** By Crufts Electronics Staff. 45s. Postage 9d.
 - Radio Upkeep and Repairs.** By A. T. Witts. 7s. 6d. Postage 5d.
 - Radio Engineer's Pocket Book.** By F. J. Camm. 3s. 6d. Postage 3d.
 - Television Receiving Equipment.** By W. T. Cocking. 12s. 6d. Postage 5d.
 - Newnes Television Manual.** By F. J. Camm. 7s. 6d. Postage 5d.
 - Principles of Radio Engineering.** By R. S. Glasgow. 30s. Postage 9d.
 - Electronics for Radiomen and Electricians.** Coyne Electrical School. 22s. 6d. Postage 9d.
 - The Amplification & Distribution of Sound.** By A. E. Greenlees. 16s. Postage 6d.
 - Motion Picture Sound Engineering.** 35s. Postage 9d.
 - A Modern Home Built Televisor.** Electronic Engineering. 2s. 6d. Postage 2d.
- We have the finest selection of British and American radio books. Complete list on application.

THE MODERN BOOK CO.
(Dept. W.6)
19-23, PRAED STREET, LONDON, W.2

ENGINEER required to take charge of small laboratory engaged on research and design for production of electro acoustic apparatus; essential qualifications. (1) experience of design for production of electronic apparatus, (2) academic qualifications, and experience of audio-frequency circuit development, and development of electro-acoustic transducers.—Apply giving full particulars of qualifications, experience, age and salary required to Box A.2459, Haddons, Salisbury Sq., London, E.C.4. [3516]

LOUDSPEAKER chief designer required by the components division of the Pesssey Company, Limited, Iford, Essex, to take charge of commercial and Government development and design of all radio and intercommunication speakers; suitable applicants must have had at least five years experience of speaker design and of putting the designs into production.—Applications, which will be treated in strict confidence, should state full details of experience and salary required and be addressed to the Personnel Manager. [3463]

VACANCY exists with Gaumont-Kalee, Ltd., Bombay for young, single man with exits and a thorough knowledge of 35mm picture projection and sound equipment; job entails constant travelling in all parts of India and Pakistan on cinema equipment service work; successful applicant must have capacity to inspire confidence and appreciation of local point of view and adaptability to an environment where European facilities are not always available; three-year contract; salary rupees 1,000 to 1,200 per month (£75 to £90), plus generous subsistence and travelling expenses.—Apply Box 6231.

RADIO engineer required by firm of radio and electrical engineers in Kenya, must be capable of construction of assisting apparatus from blue-prints and have experience in the maintenance of short wave transmitting sets and modern communication receivers; applicants should preferably be Associated Members of the Brit. I.R.E. or I.E.E. and have had several years' practical experience in this class of work; applicants must be medically fit and be prepared to undertake touring throughout Kenya, Uganda and Tanganyika. Air passage to Kenya would be provided for the person engaged, under a four-year contract; salary £720-780 per annum according to qualifications.—Applications in writing, with full particulars to Box 5363, c/o Whites, Ltd., 72, Fleet St., E.C.4. [3514]

SITUATIONS WANTED
FACTORY manager, components, radio, television, desires change young, technical, energetic, thoroughly experienced all depts.—Box 6103. [3479]

EXECUTIVE, 35, 17 years radio industry, wishes change, technical dept., management, publications, sales-promotion, works accountancy.—Box 6102. [3478]

RADIO technician, present residing Near East, 15 years' experience leading position seeking suitable employment outside Europe; please write.—Molnar, Radio Electrical Works, Famarausta, Cyprus. [3420]

YOUNG ex-Capt. R.E.M.E. B.Sc. electrical engineering, post-graduate apprenticeship in power engineering, experienced radio electronics, seeks progressive position or partnership, London district; some capital.—Box 6174

RADIO Officer, MN, 33, mrd., 14 yrs. deep-sea wide gen. exp. all types transm., receipt., radar, available immed., keen, willing start bottom if prospects, any branch industry, retail, representative, publicity, inspection, marine installation and servicing, etc. pref. Ldn. area but willing travel.—Box 6087. [3443]

AGENTS WANTED
ACTIVE representative with good retail connections required by electrical wholesalers and distributors; new proved good selling lines for radio and gramophone trade, also exceptional bargain offers from current stocks; liberal commission and expenses.—Box 6089. [3445]

BUSINESS OPPORTUNITIES
EXPORT to U.S.A.

BRITISH manufacturers of h.f. components already supplying American research labs. and manufacturers of communication equipment would consider adding to their American sales programme further (mainly electronic) components of novel or exclusive design, not manufactured in U.S.A. Advertisers would buy and export on own account (preferably unbranded articles).—Box 5558. [3363]

BUSINESSES FOR SALE AND WANTED
TRADE service business, Wiltshire, low rent, good agencies, modern van, P.A. equipment and comprehensive stock, about £1,500 incl.—Box 57, Paris, 121, Kingsway, London, W.C.2. [3419]

RADIO sales/service, contracting and trade service, N.W. Lond., excellent shop and position, superbly equipped, rent £70 p.a., established concern, excellent profits; £1,650 a.a.; agents invited.—Box 5468. [3326]

PATENTS
THE proprietor of British Patent No. 567,462, entitled "Electronic tube," offers same for licence or otherwise to ensure practical working in Great Britain.—Enquiries to Singer, Elbert, Stern and Co., Berg, 28, E. Jackson Blvd, Chicago 4, Illinois, U.S.A. [3392]



931A PHOTO-ELECTRIC CELL AND MULTIPLIER. Brand new and guaranteed. American R.C.A., only 30/- each.

BATTERY ELIMINATORS. Brand new, manufacturer's surplus. Input 200/250 v., output 60, 90 or 120 v., 30 m/a., and 2 volt 1 amp. In crackle finish box, only 45/-.

D.C. AVO MINOR. Brand new and boxed, but slightly soiled, only 55/- each. Limited quantity. Not Ex-Govt.

PAXOLIN SHEET. High grade, polished finish. Sizes 19in. x 12 1/2in. x 1/10in., 2/9 sheet; 12 1/2in. x 12 1/2in. x 1/10in. 2/- sheet, only. If ordering by post, minimum lots of 6 sheets please.

U.S. ARMY MIDGET LIGHT-WEIGHT HEADPHONES. 200 ohms, resistance. Suitable for deaf-aids, etc. Brand new and boxed, 7/6 pair only.

VCR97 G/R TUBES. Please note we are still able to supply these Ex-Govt. Tubes, brand new and guaranteed. Each tube is tested for Television suitability prior to despatch. Price 35/- each, plus 7/6 registered carriage and packing. Black rubber masks are in stock for these tubes, at 3/6 each.

6in. ENLARGING LENS. Owing to a large purchase of these items, we are now able to supply at 25/- only, plus 1/6 carriage and packing.

SPECIAL OFFER. P.M. SPEAKERS. By leading manufacturers, 5in., less Transformer 10/-; 5in., with Trans., 12/6; 6 1/2in., less Trans., 12/6; 6 1/2in., with Trans., 15/-; 8in., less Trans., 15/-; 8in., with Trans., 21/-; 10in., with Trans., 25/-, etc., and the new Truvox 6 1/2in. Water Speaker at 25/-, less Trans.

METER DISTRIBUTION BOARDS. Comprising 0-300 v. M.I. Meter, 3 1/2in. AC/DC Input Plug and Socket, 3 Output Sockets, 2 porcelain fuses. Total size 12in. x 6in. Brand new and individually boxed, 22/6 complete.

R.3084 RECEIVER. Incorporating 7 EF50, 2 EF54, 1 BC52, 1 VU89A, 1 HVR2, 1 EA50, plus 30 mc/s. I.F. Strip. Guaranteed absolutely brand new in maker's original packing case, 75/- (Plus 10/- carriage and packing.) This receiver is ideal for conversion to vision receiver.

Send stamp for current Component List. Probably the most comprehensive in the trade.

5, HARROW ROAD, LONDON, W.2
PADddington 1008/9

CUT OUT THE NOISE
WITH **NAPP** MAINS
INTERFERENCE SUPPRESSOR

An efficient screened unit of 1st class construction, Double Choke, High Voltage Condensers, Fused Terminal Connections, suitable for Radio Receivers and small Electrical Appliances.

Complete with Instructions 18/6

Traders' and Factors' Enquiries invited

The COVENTRY Company
191 DUNSTABLE ROAD, LUTON
Phone: LUTON 2677

HILL & CHURCHILL LTD.

BOOKSELLERS

SWANAGE, DORSET

Available from stock

The Radio Amateur's Handbook (A.R.R.L.) 1949.....	16/6
Fields and Waves in Modern Radio—Ramo and Whinnery	33/-
Inside the Vacuum Tube—John Rider	30/-
Servicing by Signal Tracing—John Rider	25/-
The Oscillator at Work—John Rider	17/6
Frequency Modulation—John Rider... ..	12/6
Radio, Television and Electrical Repairs—Roy Norris	10/6
Practical Radio Reference Book—Roy Norris	8/6

Postage Extra.

CATALOGUE ON APPLICATION



Time Limit fixed under Town & Country Planning Regulations! The last batch of Domestic Reflector Type Corner Heats to be made at this address is practically finished. Price in the white, £47-10-0 ex-works, order immediately. Re units see March review, page 103.

VOIGT PATENTS LTD.,
15, SILVERDALE, S.E.26
Owing to Mr. Voigt's ill-health, demonstrations only by special arrangement.

PHOTO-ELECTRIC CELLS

for Talking Picture Apparatus.

Catalogue now available

RADIO-ELECTRONICS LTD.,
St. George's Works, South Norwood,
London, S.E. 25.

BRASS, COPPER, DURAL, ALUMINIUM, BRONZEROD, BAR, SHEET TUBE, STRIP WIRE.
3,000 STANDARD STOCK SIZES

No Quantity too Small List on application

London: **H. ROLLET & Co., Ltd.** Liverpool:
6, Chesham Place S.W.1. Kirkby Estate.
SLOane 3463 SIMONSWOOD 3271/3

WE OFFER

A large range of used and new Tes.
Equipment, Converters, Recorders,
Amplifiers, Motors, Transformers, etc.

All guaranteed and at very attractive
prices.

We buy good modern used equip-
ment of all types for spot cash.
UNIVERSITY RADIO LTD.

22 LISLE STREET, LONDON, W.C.2.

Tel.: GER 4447 & 8582.

TECHNICAL TRAINING

A.M.I.E.E., City and Guilds etc. on "No Pass—No Fee" terms; over 95% successes; for full details of modern courses in all branches of electrical technology send for our 112-page handbook free and post free.—B.I.E.T. (Dept. 382A), 17, Stratford Place, London, W.1. [6270]

TUITION

THE British National Radio School

OFFERS you a career.

WRITE to-day for free booklet describing our wide range of training courses in radio, Radar, telecommunications, principles, mathematics, physics, and mechanics; correspondence and day classes for the new series of C. & G. examinations; we specialise in turning operator into "engineers", and for this course our "Four Year Plan" (leading to A.M.I.E.E. and A.M.Brit.I.R.E.E. with 9 C. & G. Certificates as interim rewards) is unsurpassed; our "guarantee has no strings attached"—Studies Director, B.Sc. A.M.I.E.E. M.Brit.I.R.E.E. 66, Addison combe Rd., Croydon, Surrey. [6811]

ENGINEERING careers and qualifications.

BOTH Government and industry have announced and emphasised that young men with technical knowledge and qualifications must receive every chance to rise to the highest positions within their capacity, in post-war engineering and allied industry; write to-day for "The Engineer's Guide to Success"—200 courses free—which shows you how you can become A.M.I.E.E., A.M.I.Mech.E., A.F.R.Ae.S., etc., and covers all branches in radio, automobile, mechanical, electrical, production, aeronautical, etc. THE Technological Institute of Great Britain, 82, Temple Bar House, London, E.C.4. [1776]

WIRELESS officer's attendance and postal courses.—Wireless Sch., Manor Gdns. N.7.

RADIO training—P.M.G. exams, and I.B.E. Diploma; prospectus free.—Technical College, Hull. [0611]

WELL-KNOWN engineer-lecturer (university graduate, A.M.I.E.E.) has limited number of vacancies for C. and G., A.I.M.E.E., etc.; first-class individual postal coaching in radio, telecomm., maths.—Box 6158. [3488]

A.M.I.Mech.E., A.M.I.E.E., City and Guilds, etc. on "No Pass—No Fee" terms, over 95% successes; for details of exams, and courses in all branches of engineering, building, etc., write for 105-page handbook—free.—B.I.E.T. (Dept. 387B), 17, Stratford Place, London, W.1.

NEW comprehensive system of tuition. M. Matric. Special Entrance. First M.B. Common Preliminary, etc. Exams. of Institutes of Civil, Electrical and Mechanical Engineers. Also electrical and telecommunications engineering courses.—Write Dept. W. Comprehensive Correspondence Schools, Ltd., 411, Oxford St., London, W.1. [3063]

TELEVISION postal course for radio trades Examination Board's diploma, also postal courses for P.M.G. 2nd and 1st class Certificates and Amateur Radio Transmitting licence.

Apply British School of Telegraphy, Ltd., 179, Clapham Rd., S.W.9. (40 years' experience in coaching students in wireless telegraphy and allied subjects.) [2586]

RADIO ENGINEERING SCHOOL. Air Service Training, Hamble, Southampton, provides the best full-time training for responsible positions in industry or aviation; students coached for C. & G. Inter, and Final Certs. in radio-telecommunications; Graduate ship of B.I.E.E., M.C.A.E., radio engineer licence, and for air and marine radio officers' licences; full details from the Commandant. [2260]

THE Institute of Practical Radio Engineers have available Home Study Courses in every phase of radio and television engineering, specialising in the practical training of apprentices in the retail trade; enrolments limited, fees moderate.—The Syllabus of Instructional Text may be obtained post free from the Secretary, I.P.R.E., Fairfield House, 20, Fairfield Road, Crouch End, London, N.8. [1614]

IMPROVED television course at greatly reduced price, widening interest and increased enrolment enable us to reduce the price of our Basic Television Postal Course by 25%, at the same time the scope of the course has been increased by including comprehensive material dealing with the latest television receiver technique.—Full details of this and other courses in Free Booklet from E.M.I. Institutes, Dept. W.W., 43, Grove Park Rd., Chiswick, London, W.4. Tel. Chiswick 4417-8. [3501]

BOOKS, INSTRUCTIONS, ETC.

WEBB'S 1948 radio map of world, new multi-colour printing, with up-to-date call signs and fresh information on heavy art paper 4/6, post 6d, on linen on rollers, 11/6, post 9d.—Webb's Radio, 1-4, Scho St., W.1. Gerrard 2089.

BRANS' "Radio Valve Vade-Mecum," 1948 edition (two vols) 18/6, only one copy per address; Brans' "Radio Schemas," five vols c.c.t.s. and servicing data for Continental sets, some British and Americans included, Vol. 1 13/6, 2 17/6, 3 20/-, 4 14/-, 5 15/-; postage 10d. per vol; set 5 vols £4, postage 2/6, only one copy each vol. per address; index available.—Peter Armstrong, 136, Bicknell Mansions, London, W.1. Weibech 4893. Cash with order only. [3604]

MORSE CODE TRAINING

There are Candler Morse Code Courses

for **BEGINNERS AND OPERATORS**

Send for this Free

"BOOK OF FACTS"

It gives full details concerning all Courses.

THE CANDLER SYSTEM CO.
(Room 55W), 121 Kingsway, London, W.C.2

Candler System Co., Denver, Colorado, U.S.A.

TOROIDAL DECADE INDUCTORS

Accuracy ±0%—LOW FIELD—INEXPENSIVE

TD1 11.1 ys. 50-2,000 cps.
TD2 1.11 Hys. 2,000-50,000 cps.
TD3 0.111 ys. 10,000-300,000 cps.

Other Units produced to special order.

LYNCAR LABORATORIES
29, Camborne Rd., Morden, Surrey. LIB. 3247

TELEVISION RECEIVERS SCANNING and FOCUS COILS TIME BASE COMPONENTS 7KV. EHT. RF. UNITS and TRANSFORMERS

Publications post free

HAYNES RADIO LTD.
Queensway, Enfield.

"PERIMET" ELECTRODE Soldering and Brazing Tool

Operates from 4 or 6 Volt Accumulator or Transformer



15s. Post free

Mains Transformer. 3 Heats. 35s. Post free.

HOLBOROW & CO.,
71, Weymouth Bay Avenue, Weymouth.

HIGH FIDELITY REPRODUCTION

We manufacture a range of high fidelity amplifiers and radio feeder units. These include local station feeder, 5gns., 6 watt amplifier 20-20,000 cycle response, 12gns. Data sheets on request, demonstration by appointment.

ELECTRO Acoustic DEVELOPMENTS
18 BROAD RD., WILLINGDON, SX.

PRECISION TEST EQUIPMENT—

PRECISION A.F. OSCILLATORS. TYPE LO.50a By B.S.R. 0 to 16,000 cycles on two dials. 0 to 600 and 0 to 16,000 cycles. As NEW and unused. £27
CRYSTAL OVENS. ADMIR. PATTERN 3190. For precision frequency control of quartz crystals (see April advertisement). New £41/7/6
SIGNAL GENERATOR TYPE 52a. By Ocosor. 6 to 52 Mcgacycles. Sine or Pulse Mod. Mains operated 230 v. 50 cycles. As New £28
U.H.F. FREQUENCY METERS TYPE TS-69/AP. Range 341 to 1,000 megacycles. Calibrated every Mc. Measuring circuit consists of precision adjustable co-axial resonator with crystal probe and microammeter for indicating resonance. Complete with spare crystals, leads, charts etc., in transit case. New ex. Gov. surplus £15/10/-
Carriage is extra on all the above.
Send for list of test equipment.

PIKE BROS.

86 MILL LANE, LONDON, N.W.6

Telephone: HAMPSTEAD 4219

B.T.S.

THE Radio firm of the South,
63 London Road, Brighton, 1, Sussex.
Phone: Brighton 1555

**SPEAKERS
BRAND NEW**

Goodman's, Truvox, Rola (as available).
5 inch 13/-; 6 inch 14/-; 8 inch 16/-
including packing and postage.

EDDYSTONE RECEIVERS

Full range of components.
All C.O.D. orders promptly executed.
Send for Catalogue, 1/- post free.

LOCKWOOD

makers of

Fine Cabinets

and woodwork of every description
for the Radio and allied trades

LOCKWOOD & COMPANY

Lowlands Road Harrow, Middlesex. Byron 3704

COPPER WIRE

ENAMELLED, SILK, D.C.C., etc., most
sizes.

INSULATING MATERIALS, Empire cloth,
leatheroid, paxolin, sleeving, etc.

MOTORS A.C. & D.C. up to 1 h.p. a speciality

Send S.A.E. for list to

STAN. HOLT,

349, HIGH ST. SMETHWICK, STAFFS.
Telephone: WOODGATE 3789

**HIGH "Q" IRON
CORED COILS**

of Unsurpassed Quality for Discerning Amateurs

AERIAL, H.F. OR OSCILLATOR, short, medium or

long wave, size of former lin. x 3/8 in. 3/9 each.

INPUT FILTER, 465 Kc/s., parallel or series tuned,

3/9 each.

DUAL WAVE COILS, medium and long wave aerial

and h.f., 9/6 pair.

I.F. TRANSFORMERS, standard, 465 Kc/s., per-

meability tuned, size 1 1/2 in. square x 3/4 in. high,

8/6 each.

All coils fitted with adjustable iron cores, and supplied

with circuit diagram.

TERMS: Cash with order or C.O.D. on orders over £1.**TRADE ENQUIRIES INVITED.****MONOCHORD RADIO**

(Established 1929)

125, Mitcham Lane, Streatham, London, S.W.16.

Phone: Streatham 5495.

RADIOMENDERS LIMITED

FOR SPECIAL TRANSFORMERS AND REWINDS

We specialise in

**AMATEURS' WINDINGS, TRANSFORMERS
ALL TYPES, CHOKES, PICK-UP COILS,
INSTRUMENT COILS, Etc.**

LOUD SPEAKER SERVICE

Highest workmanship

Good Delivery

**RADIOMENDERS, LTD.**

Television & Radio Apparatus, Transformer & Coilwinders.

123-5-7 Parchmore Road,
THORNTON HEATH, SURREY

LIV 2261. Trade enquiries invited. Established 16 years.

THE KING OF COIL PACKS.

The letters of praise we receive in our post bag every day confirm our opinion that the
MODEL 40 COIL PACK is the best that money can buy, from the point of view of
quality, workmanship and performance.

It is, to the best of our knowledge, the only unit on the market with an H.F. stage
which can be supplied prealigned and sealed for direct inclusion into a superhet
receiver. It uses 9 separate iron-cored high efficiency coils, with high stab. S.M.
padding and variable trimmers. The Waveband coverage is 16-50, 200-550 and
800-2,000 metres. Notwithstanding its compact size (5 1/2 in. x 5 1/2 in. x 2 1/2 in.)
the internal and external screening is efficient and more than adequate to eliminate any
interference between the Aerial, R.F. and Oscillator sections.

The price? Only 2 gns., or can be supplied fully aligned at 47/-. For one month
only, as a special offer, we are supplying FREE with every Model 40 Coil Pack our
comprehensive and detailed instruction sheets for the construction of a 6 valve
superhet receiver embodying this unit. These sheets are really comprehensive and
even if you have never built a radio receiver before, you can go ahead with the
knowledge that you cannot fail to complete a highly efficient multi-valve receiver,
that will give you years of pleasurable listening or DX roaming.

Send 1/- for the latest issue of "The Home Constructor's Handbook," or a 2d
stamp will bring you our latest lists.

Phone, write or call: **LONDON TELEVISION CO., LTD.,**
694 LEA BRIDGE ROAD, LEYTON, E.10. Telephone: LEY. 4380

POTENTIOMETERS

by

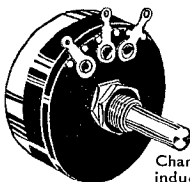
RELIANCE

Wire-wound and Composition types.
Single, Ganged, Tandem Units.

Characteristics: linear, log., semi-log., non-
inductive, etc. Full details on request.

RELIANCE MFG. CO. (SOUTHWARK), LTD.,

Sutherland Road, Higham Hill, Walthamstow, E.17.

Telephone: Larkwood 3245

**KERSHAW'S KORNER KALLING
SPECIAL!!!****M.O.S. LINES**

TELESONIC RECEIVERS, brand new, complete with
four 1.5 v. Hivac Midget valves ideal for making your own
personal portable 32/6 each. Post paid.

INERT 1.5 v. CELL BATTERIES, long life, fill with
plain water and have continuous use. Ideal for every
purpose. 3 for 2/6. Post paid.

MAKE YOUR OWN CRYSTAL SET, with polished
terminal box complete with volume control, resistance,
etc. 1/6 each. Post paid.

S. KERSHAW

93/95 PERSHORE STREET, BIRMINGHAM, 5.

WILKINSON'S OF CROYDON**ELECTROLYTIC**, 8 MED 500 v. BR850, 3/- each, 34/- doz. NEW STOCK.**P.M. SPEAKERS**, 8in. with transformer, in wall case, 21/-.**POWER UNIT**, employing a 524G and a high voltage rectifier SU2150A, together

with a 1 mf. condenser, 2.5 kV. and other components, 17/6 post free.

TELEVISION Unit, 2HF stages, 1 detector and 1 video amplifier, complete with

4 valves, adjustable iron-cored coils, etc., brand new, only 45/-.

FLAN POSITION Indicator Unit, Brand new 1 Ex-U.S. Navy. Employing 40

useful valves, 2 Cathode Ray tubes, power pack, motor blower, Milliammeters, etc.

The following are the valves: 13 6SN7GT, 3 6AC7, 2 6L6, 6 6L6G, 3 VR150-30,

1 2X2, 3 5U4G, 2 6X5G, 2 6HG. **SPECIAL PRICE £16/10/-.****SLOW MOTION DIAL**, With Vernier 200-1 reduction. Front of panel mounting,

6in. diam., calibration 0-100, 5/6 each.

MULTI-AD SLOW MOTION DRIVES, ratio 50-1, 7/6 EACH.**MILBREAD SLOW MOTION DRIVES**, ratio 50-1, 7/6 EACH.

also many useful relays, Resistors, Condensers, and a Dynamotor with extended

spindle which will work as a powerful motor on 200/250 A.C. mains without altera-

tion. 145 items in all, brand new, properly packed, 70/- complete.

CO-AXIAL LEAD, 27ft., fitted with Pye Sockets, each end, 3/6 each.**CRYSTAL MULTIPLIER UNIT**, 2 to 6.67 Mc/s in 3-switch steps, 807 Oscillator and

tuning control. Brand new with two 807 valves, instruction books, etc., 55/- EACH.

RF AMPLIFIER, 100/124 Mc/s for 2V7B2 Triodes in push pull, standard 19in. rack

mounting, easily modified for 144 Mc/s. Brand new, 75/-.

FREQUENCY STANDARD 1,000, 100, 10 K.C. Brand new American equipment,

110/250 volts, £8/8/-.

METAL RECTIFIERS, 60 M/A, 230 volts, 1/2 wave, 3/- each. List 24d.**L. WILKINSON, 204, Lower Addiscombe Road, CROYDON****CIGARETTES AND WHUSKEY!**

Yes, we really felt justified in calling for a celebration when we put our latest receiver,

THE MODEL 40 6-VALVE SUPERHET

through its paces!

The performance of this receiver is outstanding on all bands—as, of course, being
designed round the FAMOUS MODEL 40 COIL PACK and "H.M." I.F. TRANS-
FORMERS, is only to be expected. Sensitivity, selectivity, volume and quality of
reproduction, leave nothing to be desired. In addition, a High Fidelity Switch
for local station listening and the use of an effective tone control for removing nasty
scratch on "gram," are refinements that make for real luxury listening. A stout
aluminium chassis and the latest Horizontal JB Tuning Assembly with spin wheel
tuning, three colour edge lit glass dial and bronze escutcheon ensure that the appearance
is superb.

This is the set for the connoisseur! Supplied complete with valves and 10in. loud-
speaker, at the price of 16 gns. inclusive. A stamp will bring you fuller particulars.
DON'T FORGET that we also carry a complete range of components and specialise
in pre-aligned and matched superhet components for the home constructor. Send
stamp for latest bulletin and list or, if you want a book of circuits and radio informa-
tion, together with a full list of all our products and how to use them, you can't do
better than invest 1/- in a copy of our HOME CONSTRUCTOR'S HANDBOOK.

SUPACOILS, 98, Greenway Avenue, London, E.17

INDEX TO ADVERTISERS

	PAGE		PAGE		PAGE
AA. Tools	72	Galpins	71	Quartz Crystal Co., Ltd.	70
Acoustical Mfg. Co., Ltd.	56	General Electric Co., Ltd.	33, 59	Radio-Electronics, Ltd.	78
Acorn Electric Tool Mfg. Co., Ltd., The	30	General Lamination Products Ltd	19	Radiomart (B'ham), Ltd.	14
Adgola Products, Ltd.	16	General Sonic Industries	18	Radiomenders, Ltd.	79
Aerialite, Ltd.	16	Glaser, L.	74	Radiopares, Ltd.	74
Airmec Laboratories, Ltd.	36	Goodmans Industries, Ltd.	26	Radiovision (Leicester), Ltd.	80
Albert Mfg. Co.	74	Goodsell, Ltd.	32	Radio Unit	75
All-Power Transformers, Ltd.	38	Gramplan Reproducers Ltd	32	Record Electrical Co., Ltd., The	66
Allan, Richard, Radio, Ltd.	18	Gray, A., Ltd.	20	Reliance Mfg. Co. (Southwark), Ltd	79
Antiference Ltd	235	Hartley, H. A., Co., Ltd.	62	Reproducers & Amplifiers, Ltd.	55
Armstrong Wireless & Television Co., Ltd.	65	Haynes Radio, Ltd.	78	Rimington Van Wyck, Ltd.	34
Ashworth, H.	54	Hazelhurst Designs, Ltd.	28	Ritherdon & Co., Ltd.	14
Astor Boisselier & Lawrence, Ltd.	18	Henley's, W. T., Telegraph Works Co. Ltd	68	Roding Laboratories (Electronics)	66
Automatic Coil Winder & Electrical Equip. Co., Ltd.	1	Henry's	77	Rogers Developments Co.	64
A.W.F. Radio Products, Ltd.	70	Hill & Churchill, Ltd.	78	Rollet, H., & Co., Ltd.	78
Bakers "Selhurst" Radio	26	Holborow & Co.	78	Royal Australian Air Force, The	57
Barker, A. C.	66	Holt, Stan	79	Rubber Bonders, Ltd.	21
Belling & Lee, Ltd.	66	H.P. Radio Services, Ltd.	54	Salford Electrical Instruments, Ltd.	48
Bird S. S. & Sons Ltd	60	International Correspondence School, Ltd	40	Sangamo Weston, Ltd.	6
Birmingham Sound Reproducers, Ltd.	42	Johnson, Matthey & Co., Ltd.	5	Scharf, Erwin	72
Borough Polytechnic	72	Kershaw, S.	79	Simon Sound Service	52
Brierley, J. H. (Gramophones & Record- ings), Ltd.	28	Kolectric, Ltd.	8	Smith W. H., & Son, Ltd.	68
Brighton Tele-Services	73	Labgear, Ltd.	22	Sobell Industries, Ltd.	8
Britain Chas. (Radio) Ltd.	69	Lasky's Radio	75	Sound Sales, Ltd.	50
British Institute of Engineering Tech- nology	68, 73, 74	Leak, H. J., & Co. Ltd.	13	Southern Radio Supply, Ltd.	70
British Insulated Callender's Cables, Ltd.	Cover ii	Lockwood & Co.	76	Sphere Radio, Ltd.	16
British National Radio School	74	Londex, Ltd.	76	Stability Radio Components, Ltd.	40
British N.S.F. Co., Ltd.	74	London Central Radio Stores	37	Standard Telephones & Cables, Ltd.	45, 51
British Physical Laboratories	34	London Radio Supply Co.	76	Sealtite & Porcelain Products, Ltd.	15
British Roia, Ltd.	59	London Television Co., Ltd., The	76	Stern Radio, Ltd.	67
Brookes Crystals, Ltd.	76	Lowther Mfg. Co.	66	Stratton & Co., Ltd.	3
Brown, Alan	79	Lustaphone, Ltd.	79	Sugden, A. R., & Co. (Engineers), Ltd.	10
Brown, S. G. Ltd.	58	Lyons Claude, Ltd.	64	Supacolis	79
Bulgin, A. F., & Co., Ltd.	Ldit. 239	Mall Order Supply Co.	22	Taylor Electrical Instruments, Ltd.	36, 41
Bull, J., & Sons	71	Majestic Winding Co.	33	Taylor Tunnickliff (Refractories), Ltd.	2
Bull's Ex-Govt. Depot	26	Marconi Instruments, Ltd.	32	Tele-Radio (1943), Ltd.	60
Cabot Radio Co., Ltd.	24	Marconi Wireless Telegraph Co., Ltd.	57	Telegraph Condenser Co., Ltd.	Cover iii
Candler System Co.	78	Measuring Instruments (Pullin), Ltd.	28	Telegraph Construction & Maintenance Co., Ltd., The	55
Charles Amplifiers, Ltd.	23	Metro Pex, Ltd.	20	Teleradio Co.	68
Cinema-Television, Ltd.	19	Midland Instrument Co.	75	Thermionic Products, Ltd.	11
Clydesdale Supply Co., Ltd.	73	Millett & Holden, Ltd.	77	Transradio, Ltd.	50
Cohen, D.	38	Modern Book Co.	79	Trix Electrical Co., Ltd.	Edit. 231
Cosmocond, Ltd.	58	Monochord Radio	77	Truvox Eng. Co., Ltd.	35
Coulphone Radio	58	M.R. Supplies, Ltd.	18	Universal Electrical Instruments Corpn.	73
Coventry Radio	77	M.S.S. Recording Co., Ltd.	24, 44	University Radio, Ltd.	34, 78
Davis, Alec., Supplies Ltd.	53	Mullard Electronic Products, Ltd.	52	Valradio	60
Denco Distributors, Ltd.	75	Multicores Solders, Ltd.	Cover iv	Victoria Instruments	10
Desoutter Bros., Ltd.	17	Murphy Radio, Ltd.	31	Vitavox, Ltd.	48
Dismore, L. P.	76	Mycalex, Ltd.	6	Voigt Patents, Ltd.	78
Dupley Electronics, Ltd.	76	Nagard, Ltd.	60	Vortexion, Ltd.	46
Edison Swan Electric Co., Ltd.	25, 39	Oliver Pell Control, Ltd.	80	Wayne Kerr Labs., Ltd., The	30
Electradix Radios	63	Oxley Developments Co., Ltd.	60	Webb's Radio	4
Electric & Musical Industries, Ltd.	50	Painton & Co., Ltd.	30	Westinghouse Brake & Signal Co., Ltd	12
Electrical Sound & Television Patents, Ltd.	38	Park Radio	22	West, Spencer	72
Electro Acoustic Developments	78	Partridge Transformers, Ltd.	22	Wharfedale Wireless Works	53
Electro Technical Assemblies	64	Peerless Radio, Ltd.	64	Whiteley Electrical Radio Co., Ltd.	41
Electronic Instruments, Ltd.	20	Pennine Amplifiers	64	Wilkins & Wright, Ltd.	56
Elmsleigh Radio Co.	72	Pifco, Ltd.	2	Wilkinson, L.	79
Emdo, Ltd.	76	Pike Bros., & Partners	7	Wilson, M., Ltd.	Edit. 233
Enthoven, H. J., & Sons, Ltd.	40	Post Radio Supplies	74	Wimbleton Eng. Co., Ltd.	14
Erie Resistor, Ltd.	49	Premier Radio Co.	29	Wireless Instruments (Leeds), Ltd.	72
Factor, J., Ltd.	70			Wireless Supplies Unlimited	76
Ferranti, Ltd.	27			Woden Transformer Co., Ltd.	7
Fluxite, Ltd.	Edit. 237			Wolsey Television, Ltd.	38
Fritch Radiocraft, Ltd.	36			Wright & Weaire, Ltd.	43
Furzehill Laboratories, Ltd.	4				



Products of
Quality & Reliability

MAINS TRANSFORMERS
A. F. TRANSFORMERS
THERMAL DELAY SWITCHES
SMOOTHING CHOKES
POWER RESISTANCES

Made by

OLIVER PELL CONTROL LTD

Telephone: WOOLWICH 1422-1426
CAMBRIDGE ROW • WOOLWICH • S.E.18

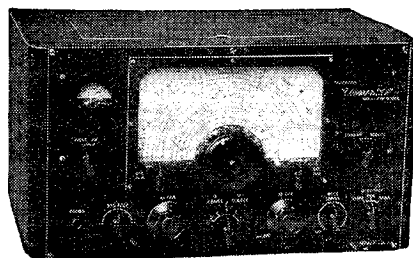

The "Commander" Model "B"

A
Special
"Double-Superhet"

Communications
Receiver for
Amateur and
Commercial
purposes.

£48.10.0 nett.
Write for details.

Complete Operating and Servicing
Handbook available 5/- ea. Designed and manufactured by:

RADIOVISION (Leicester) LTD., 58-60, RUTLAND ST.,
Phone: 20187 Cables: Hamiltonal, LEICESTER.



new MINIATURE
'METALMITES'

*down in size
 up in performance*

**SUPER TROPICAL RANGE FOR OPERATING
 TEMPERATURES UP TO 100° C**

In these new 'Metalmite' types exacting performance is allied to the smallest possible physical dimensions. They are resistant to extreme tropical conditions and have been designed for use in miniature transmitters and receivers, deaf aid equipment, etc. Their short length renders them very adaptable in small assemblies. Send for full details.

CONSTRUCTION: in solid aluminium foil and two separate layers of paper dielectric, thus giving high insulation resistance together with low power factor. Assembled in aluminium tubes and hermetically sealed with synthetic rubber bungs.

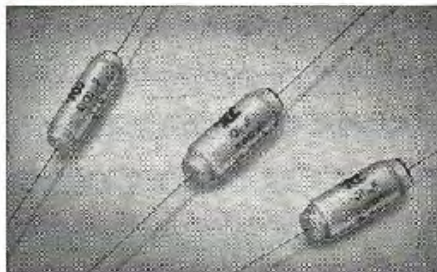

Capacitance μF	Working Volts D.C.		Dimensions in inches		Type Number	List Price Each
	at 71°C.	at 100°C.	Length	Dia.		
.0002	500	350	.010	0.2	CP110S	2/-
.0003	500	350		0.2	CP110S	2/-
.0005	500	350		0.2	CP110S	2/-
.001	350	200		0.2	CP110N	2/-
.002	350	200		0.22	CP111N	2/-
.005	200	120		0.22	CP111H	2/-
.01	200	120		0.25	CP112H	2/-
.01	350	200		0.34	CP113N	2/2

THE TELEGRAPH CONDENSER CO. LTD.

RADIO DIVISION

NORTH ACTON · LONDON · W.3

Telephone. ACORN 0061



The preferred solder for **TELEVISION** in Britain and U.S.A.

Television manufacturers in Britain and the U.S.A. prefer Ersin Multicore Solder because only by its 3 core construction can flux continuity be guaranteed and real high speed soldering be achieved with the utmost economy of material.



IN BRITAIN

One of the assembly lines in Bush Radio Chiswick Works, where the new Bush Television TV.11 receiver is now in production—one of the majority of British Television factories where Ersin Multicore Solder is used exclusively. The 509 connections in the set are all Ersin Multicore soldered, thereby eliminating H.R. and dry joints.

IN THE U.S.A.

Despite the fact that the U.S.A. are the world's largest manufacturers of cored solder, leading television makers such as Du Mont have found that the certainty of joints made with British manufactured Ersin Multicore Solder cuts both labour and material costs. At the New York Show of the Institute of Radio Engineers, specimens of these and other television receivers were shown on the Ersin Multicore stand.

Samples and prices of bulk supplies gladly sent to manufacturers on request



PRICES FOR SIZE 1 CARTONS

Catalogue Ref. No.	Alloy Tin/Lead	S.W.G.	Approx. Length per carton	List Price per carton (subject)	
				s.	d.
C 16014	60/40	14	32 feet	6	0
C 16018	60/40	18	84 feet	6	9
C 14013	40/60	13	20 feet	4	10
C 14016	40/60	16	44 feet	5	3

MULTICORE SOLDERS LTD.

Mellier House,
London, W.1.



Albemarle Street,
Tel.: REGent 1411